

Kindred Heirloom Collection
Osage Dining Table in Walnut
Dimensions: 90"L x 43"W x 30"H
Seats: 8

Flat Pack Parts Manifest

- 1) Table Top
- 2) Center Stretcher
- 3) End Trestle (2)
- 4) Wedges (2)
- 5) Bolts (4)

Drawn By
Martin Eduard Goebel
Saint Louis, USA
1/12/2023



SIDE VIEW

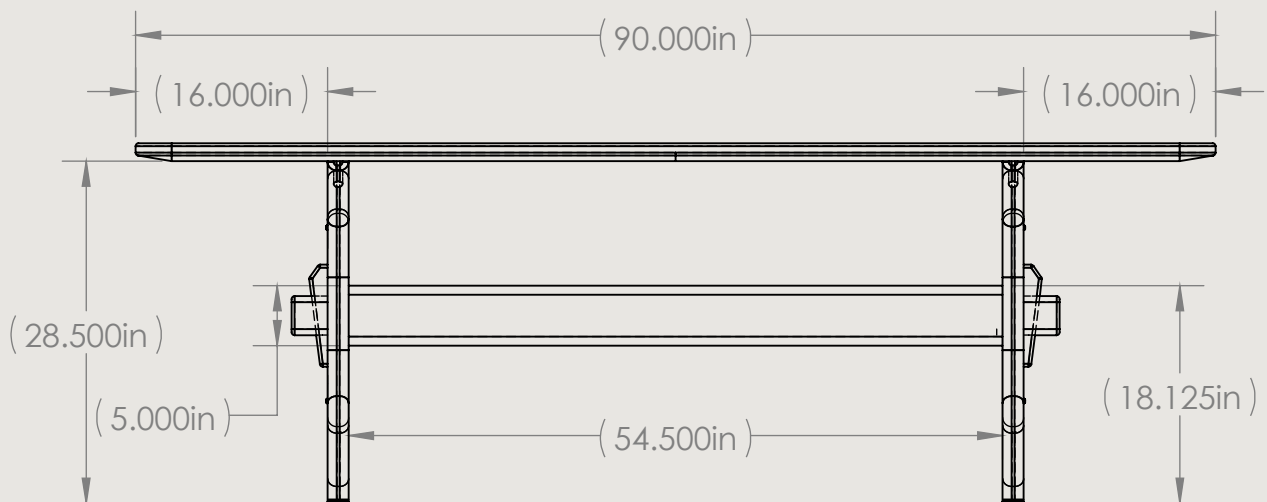

Kindred Heirloom Collection
Osage Dining Table
Dimensions: 90"L x 43"W x 30"H
Seats: 8

FRONT VIEW

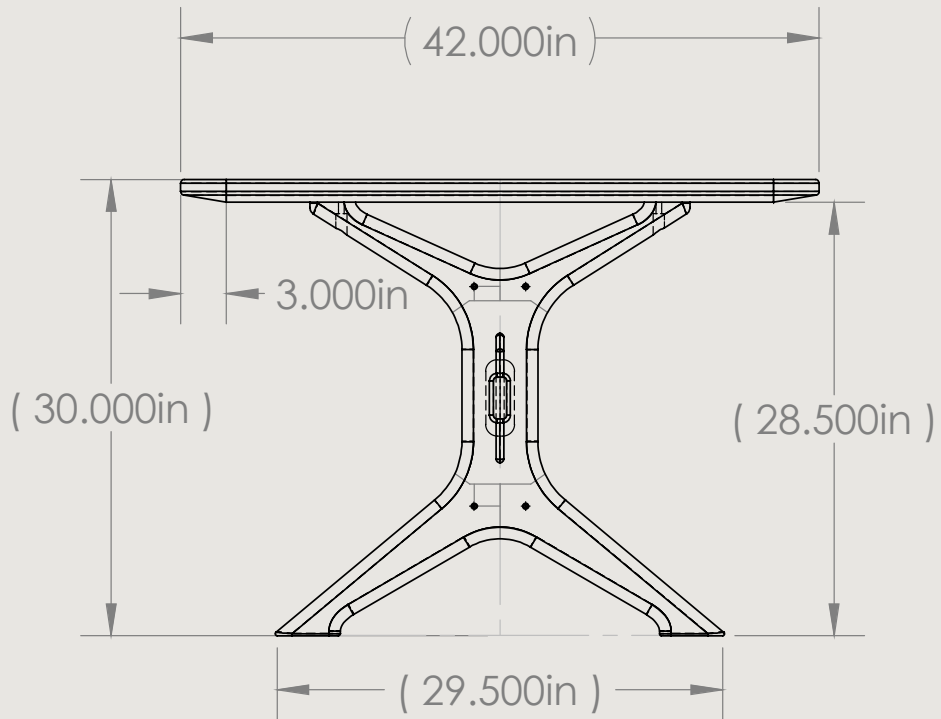

TOP VIEW

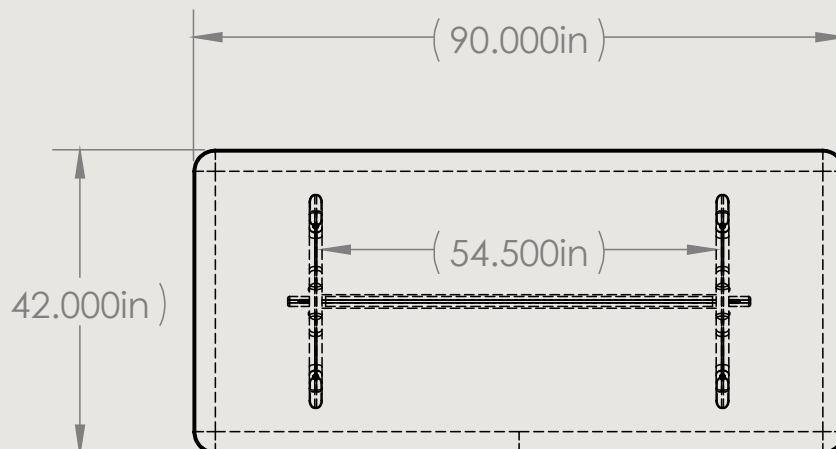

Kindred Heirloom Collection
Osage Dining Table
Dimensions: 90"L x 43"W x 30"H
Seats: 8

PERSPECTIVE VIEW

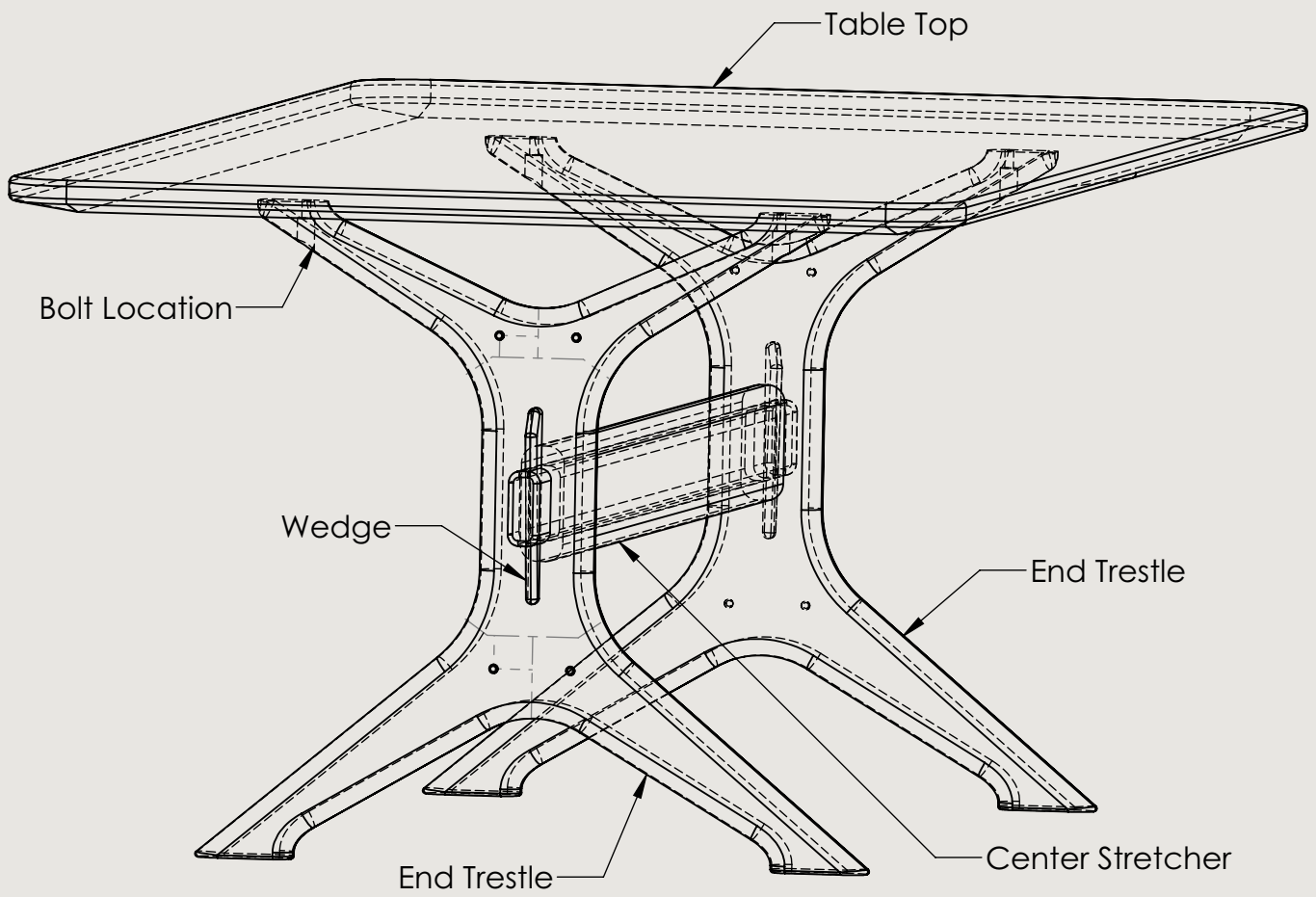

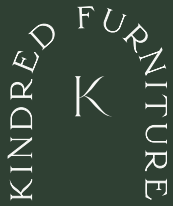

Kindred Heirloom Collection
Osage Dining Table
Dimensions: 90"L x 43"W x 30"H
Seats: 8

ASSEMBLY INSTRUCTIONS

Inventory of Parts

- a. Table top
- b. Trestles (2)
- c. Center Stretcher
- d. Wedges (2)
- e. Bolts (4)

1) Place the end trestles on the floor with the brass pin side facing down.

2) Insert the Center Stretcher through the hole in the first Trestle and place it on its feet (Teflon pad side down).

3) Pick up the second Trestle and place it on the other side of the Center Stretcher.

4) Make sure the wide side of the holes in the center stretcher face up.

5) Tap in the wedges with a mallet or padded hammer, flat side against the Trestle and wide side up. Give it a good tap until you hear a dull "thud".

6) Place the table top on the base and screw the bolts through the Trestle into the bottom of the table top.

7) If the table rocks or wiggles tap the wedges in a little further.

8) If the table still rocks, likely the floor is a little uneven. Small shims can be added under the feet/slides to eliminate rocking.

9) Order pizza.

10) Enjoy.

CARE AND CLEANING

Kindred furniture is finished with a proprietary blend of natural Tung oil created to ensure lasting beauty for generations of use. The penetrating finish sits below the surface creating a buttery, durable surface of polished American hardwood.

In the event blemishes occur (mainly from heat or sharp objects), a small reapplication of Kindred Maintenance oil with a fine (white) scotch-bright pad will polish away many of the fingerprints of life. Kindred finishes are food-contact safe.