

ASSEMBLY INSTRUCTION

FULL ROUND BED WITH DRAWERS

INSTRUCTIONS DE MONTAGE

LIT ROND COMPLET AVEC TIROIRS

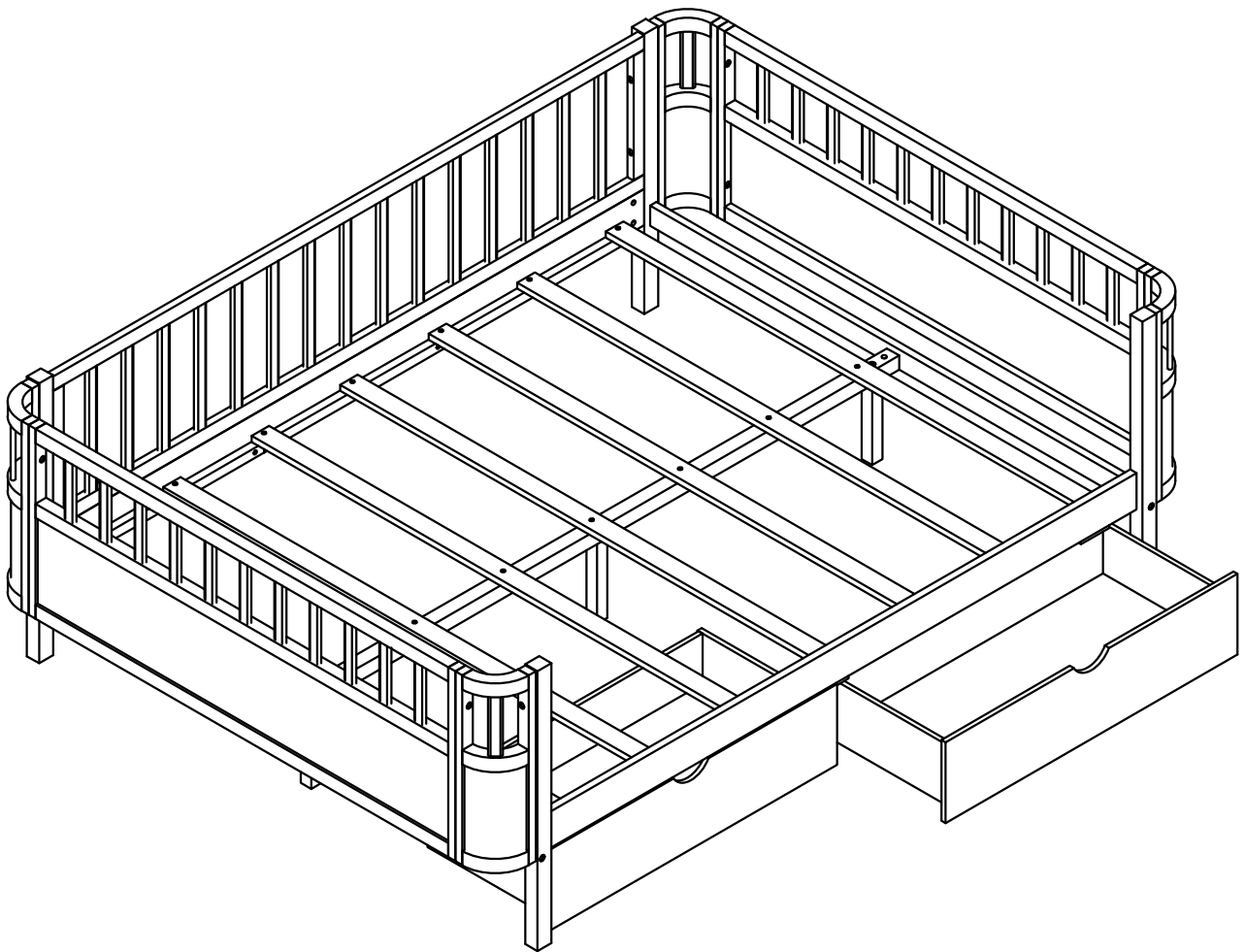

Bed type	Length	Width	Thickness
Full Standard	75"	54"	6" max
Type de lit	Longueur	Largeur	Épaisseur
Complète Standard	75"	54"	6" maximum

This set is included 1 boxes if don't receive full 1 boxes please contact our customer service team.





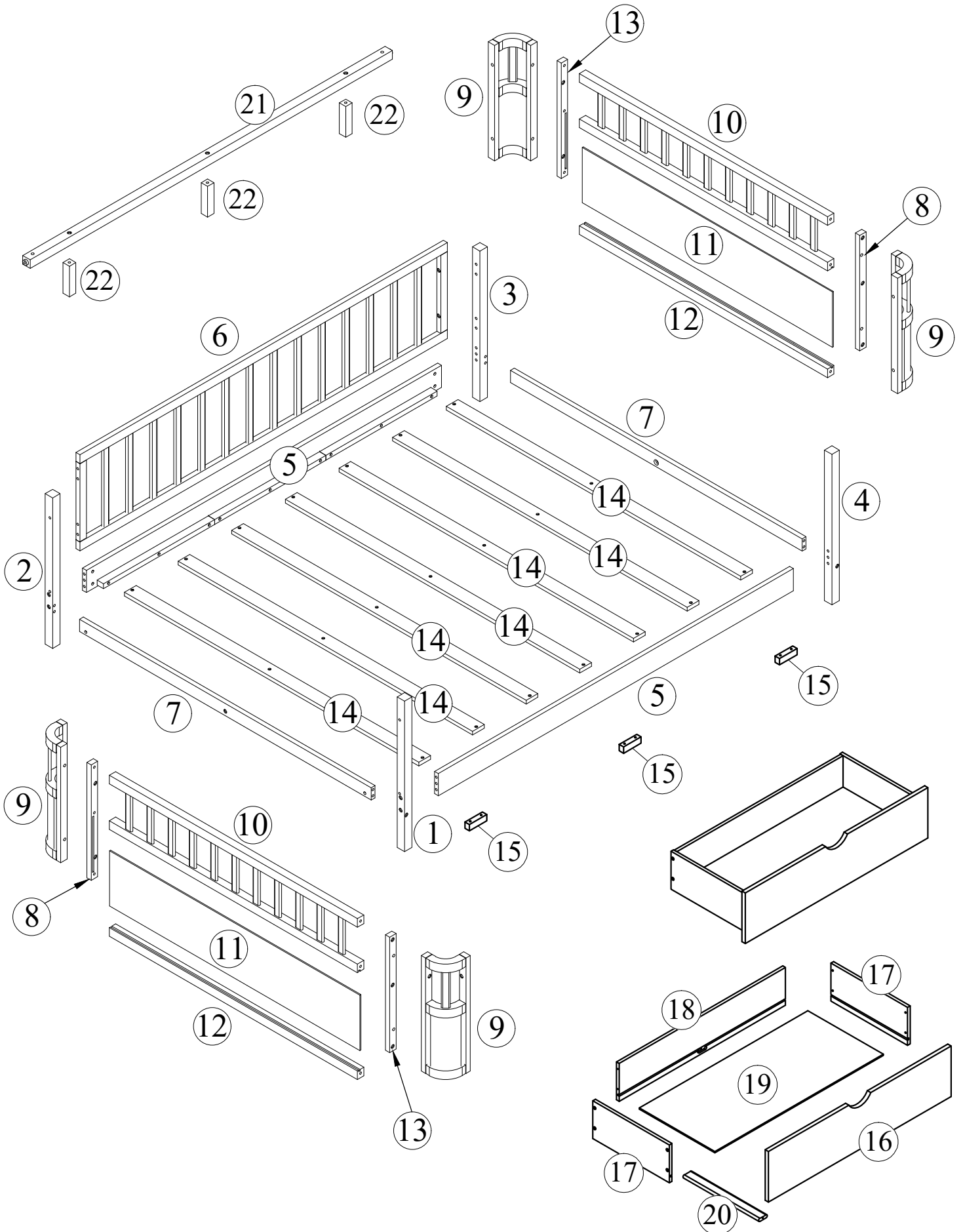





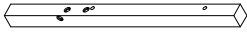
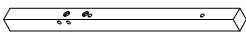
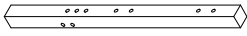

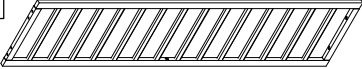
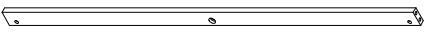
Cet ensemble comprend 1 boîtes. Si vous ne recevez pas 1 boîtes complètes, veuillez contacter notre service client.

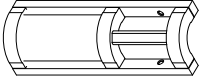
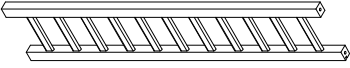
Detail View
vue détaillée

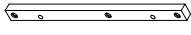
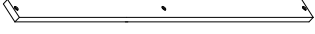

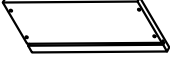
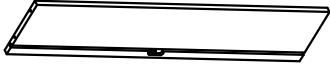

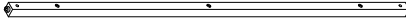





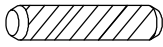
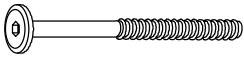

Part List

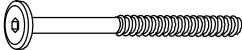
Liste des pièces

<p>1</p>  <p>Left Front Leg-1pc Jambe avant gauche</p>	<p>2</p>  <p>Left Hind Leg-1pc Patte arrière gauche</p>	<p>3</p>  <p>Right Hind Leg-1pc Patte arrière droite</p>
<p>4</p>  <p>Right Front Leg-1pc Jambe avant droite</p>	<p>5</p>  <p>Bed Shoulder-2pcs Épaule du lit</p>	<p>6</p>  <p>Rear Railing Frame-1pc Cadre de garde-corps arrière</p>
<p>7</p>  <p>Bottom Brace-2pcs Renfort inférieur</p>	<p>8</p>  <p>Standing Hip Puzzle-2pcs Puzzle de la hanche debout</p>	<p>9</p>  <p>Curved Frame-4pcs Cadre courbé</p>
<p>10</p>  <p>Upper Hip Frame-2pcs Cadre de hanche supérieur</p>	<p>11</p>  <p>Side Board-2pcs Buffet</p>	<p>12</p>  <p>Lower Hip Bar-2pcs Barre de hanche inférieure</p>
<p>13</p>  <p>Standing Hip Puzzle-2pcs Puzzle de la hanche debout</p>	<p>14</p>  <p>Slat-7pcs Lamelle</p>	<p>15</p>  <p>Blocker-3pcs Bloqueuse</p>
<p>16</p>  <p>Drawer front-2pcs Façade du tiroir</p>	<p>17</p>  <p>Drawer (Left / Right)-4pcs Tiroir (gauche / droite)</p>	<p>18</p>  <p>Drawer back-2pcs Arrière du tiroir</p>
<p>19</p>  <p>Drawer back-2pcs Arrière du tiroir</p>	<p>20</p>  <p>Drawer support-2pcs Support de tiroir</p>	<p>21</p>  <p>Flap Support-1pc Support de rabat</p>
<p>22</p>  <p>Lower Legs-3pcs Jambes inférieures</p>		

Hardware List

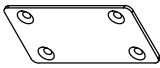
Liste du matériel

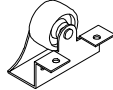
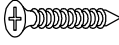
A  8 X 30mm.	B  Ø1/4" x 70mm	C  Ø1/4" x 13mm
Wooden dowel (12pcs) Cheville en bois	Hex-head bolt (12pcs) Boulon à tête hexagonale	Horizontal-hole bolt (14pcs) Boulon à trou horizontal
D  Ø1/4" x 50mm	E  Ø1/4" x 35mm	G  Ø1/4" x 15mm
Hex-head bolt (9pcs) Boulon à tête hexagonale	Hex-head bolt (20pcs) Boulon à tête hexagonale	Sleeve nuts (8pcs) Écrous à manchon
H  #4 x 30mm	I  K4mm	J  Ø1/4" x 30mm
Screw (45pcs) Vis	Allen key (1pc) Clé Allen	Hex-head bolt (8pcs) Boulon à tête hexagonale
F  2x35x70mm	K  #3.5 x 15mm	L  Sliding Wheel (8pcs)
Straight bracket (1pc) Support droit	Screw (4pcs) Vis	Sliding Wheel (8pcs)
M  #3.5 x 10mm		
Screw (32pcs) Vis		

Please sort out all parts before you begin to assembly the item. This is to make sure you always use the correct part.

Veuillez trier toutes les pièces avant de commencer à assembler l'article. Ceci afin de vous assurer que vous utilisez toujours la bonne pièce.

ASSEMBLY TOOLS REQUIRED (NOT INCLUDED)
OUTILS D'ASSEMBLAGE REQUIS (NON INCLUS)

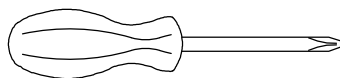

PLEASE BE CAREFUL DO NOT DAMAGE THE HOLE POSITION WHEN YOU USE POWER TOOLS !

S'IL VOUS PLAÎT FAITES ATTENTION À NE PAS ENDOMMAGER LE TROU POSITIONNEMENT LORSQUE VOUS UTILISEZ DES OUTILS ÉLECTRIQUES !

STEP-ÉTAPE- 1



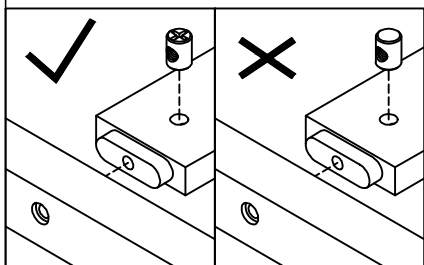
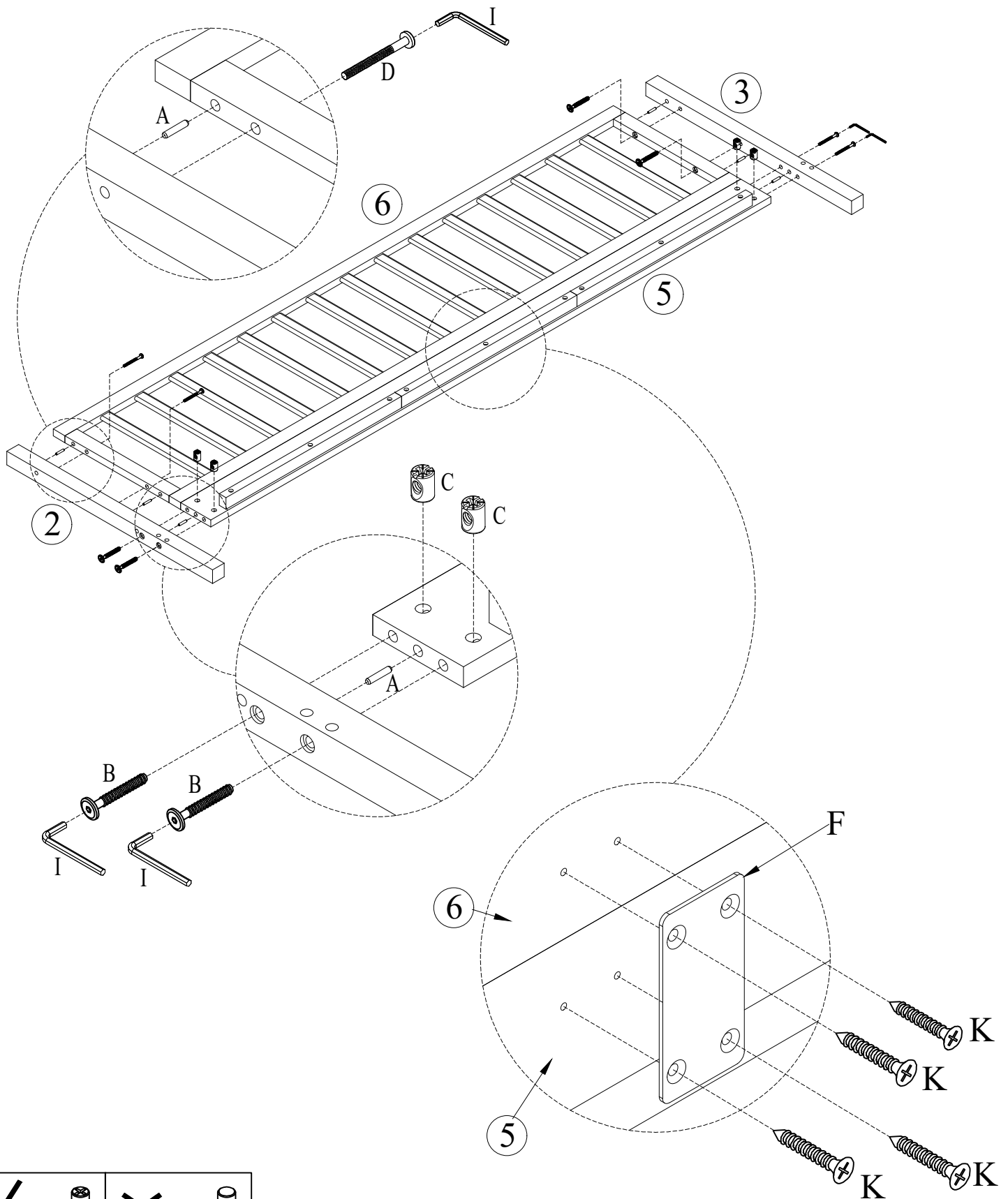

F	K	A	D	I	B	C
1PC	4PCS	6PCS	4PCS	1PC	4PCS	4PCS



Note: Part (C) will face up with the "x" mark on it, otherwise it cannot be tightened.



Remarque : la partie (C) sera orientée vers le haut avec la marque « x » dessus, sinon elle ne pourra pas être serrée.

STEP-ÉTAPE- 2

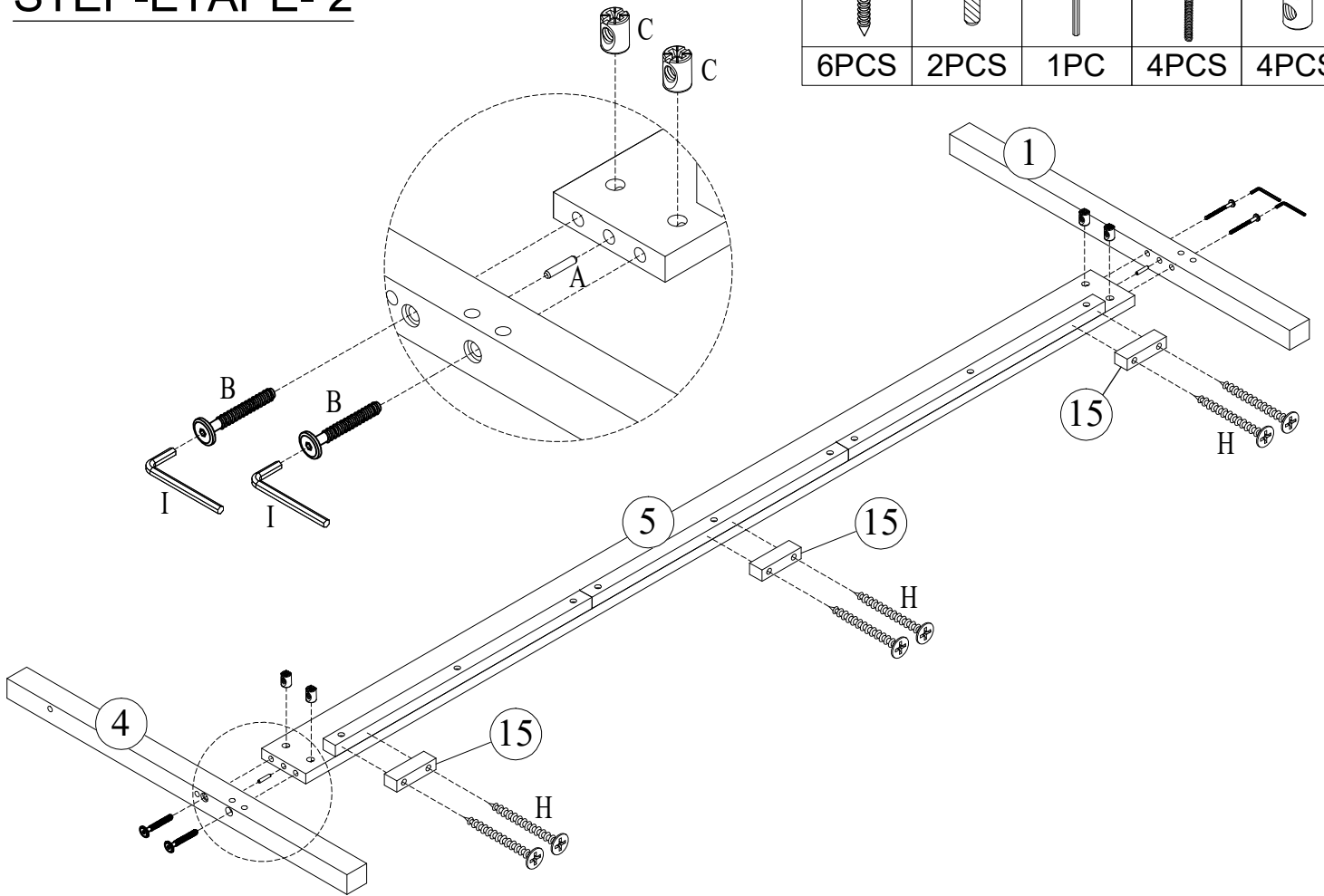
H		A		I		B		C	
6PCS		2PCS		1PC		4PCS		4PCS	



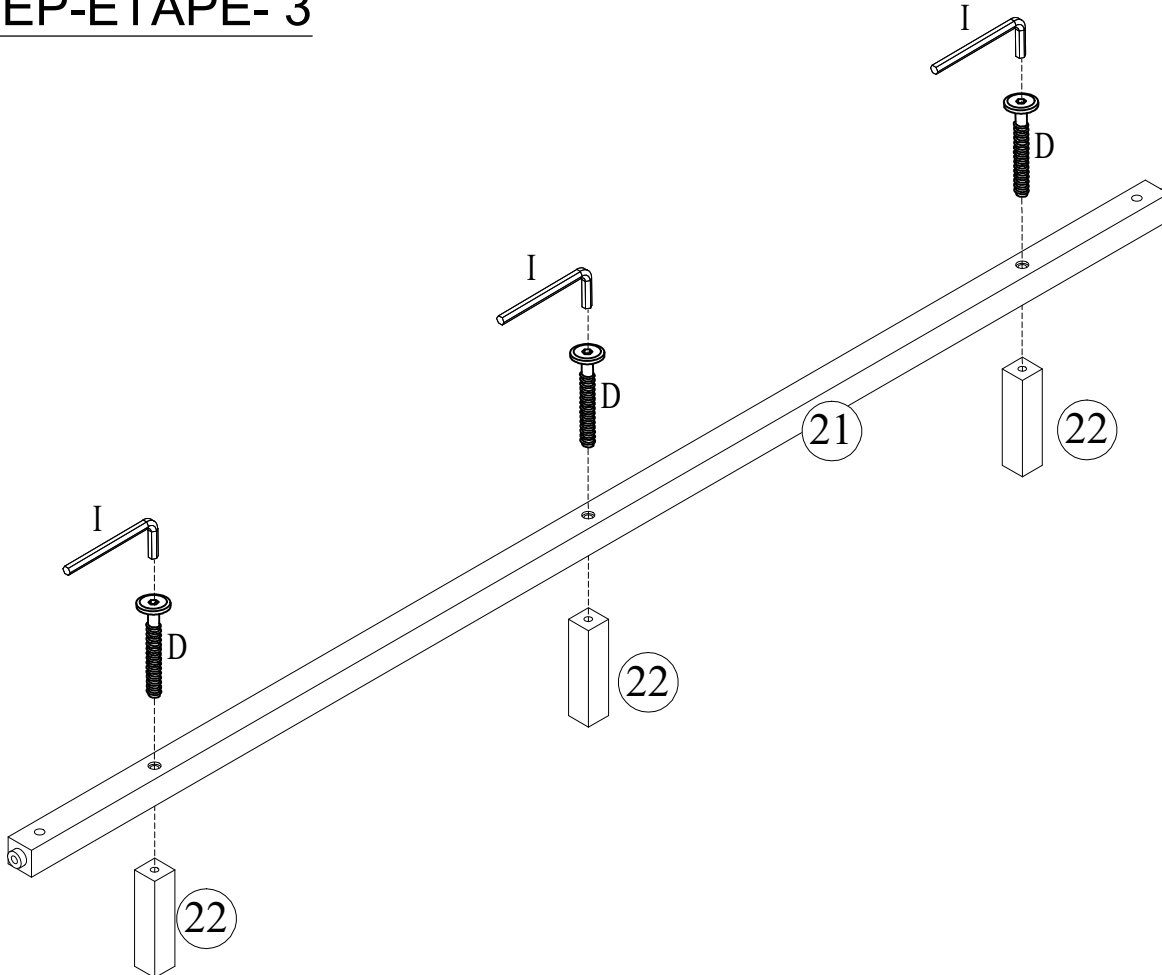

STEP-ÉTAPE- 3

I		D	
1PC		3PCS	



STEP-ÉTAPE- 4



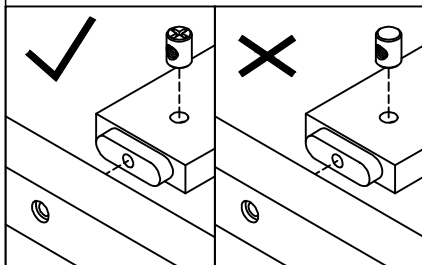
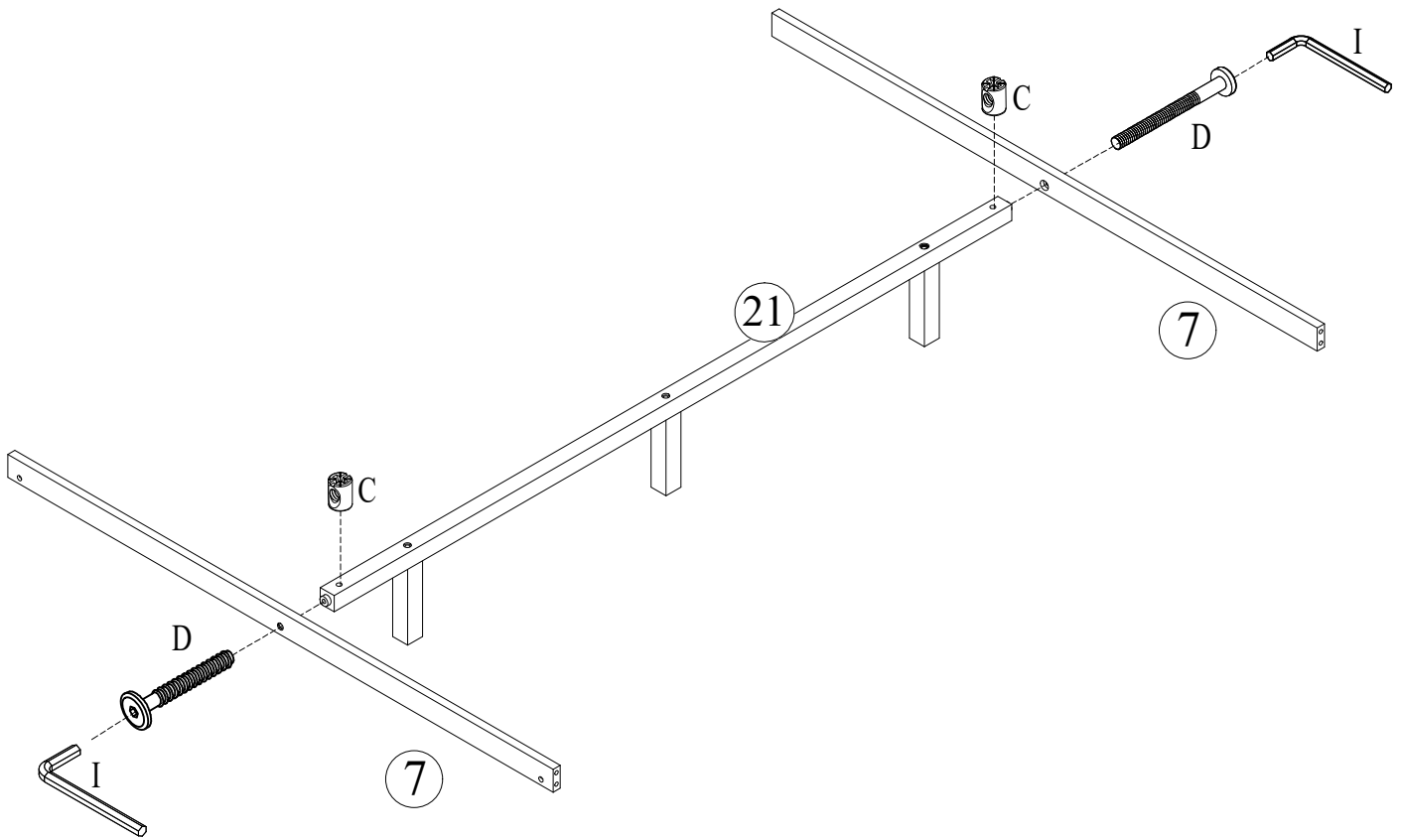

I	D	C
		
1PC	2PCS	2PCS



Note: Part (C) will face up with the "x" mark on it, otherwise it cannot be tightened.

Remarque : la partie (C) sera orientée vers le haut avec la marque « x » dessus, sinon elle ne pourra pas être serrée.

STEP-ÉTAPE- 5

A	I	B	C
			
4PCS	1PC	4PCS	4PCS

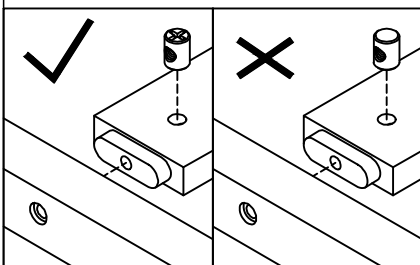
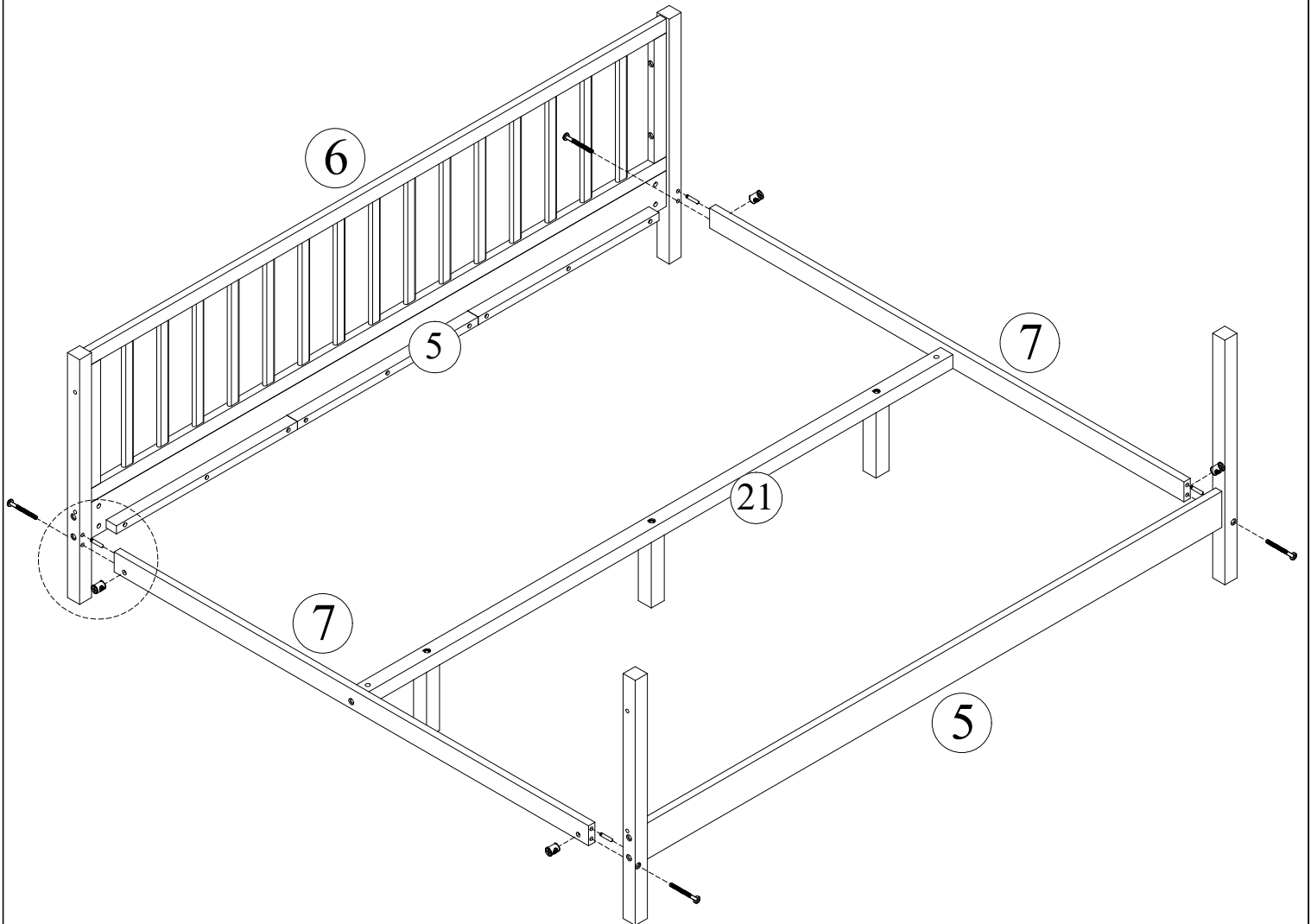
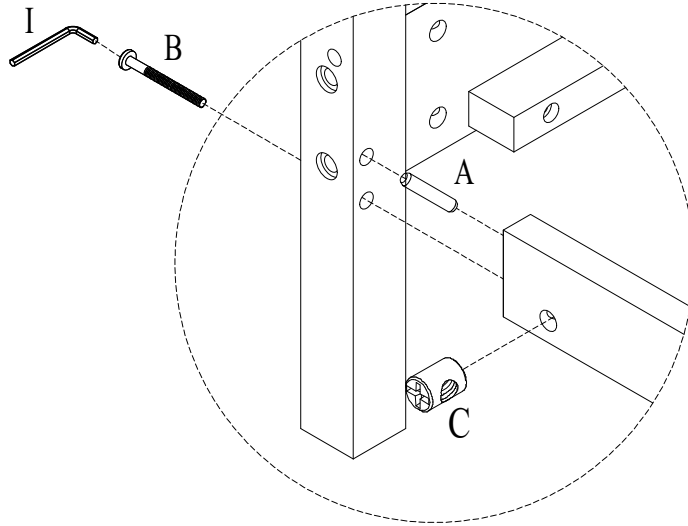

Note: Part (C) will face up with the "x" mark on it, otherwise it cannot be tightened.

Remarque : la partie (C) sera orientée vers le haut avec la marque « x » dessus, sinon elle ne pourra pas être serrée.

STEP-ÉTAPE- 6

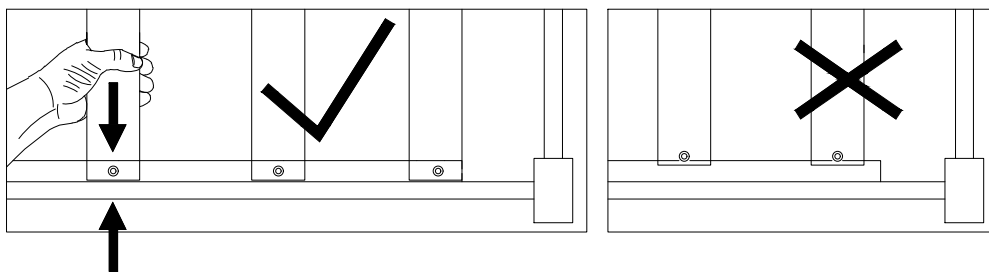
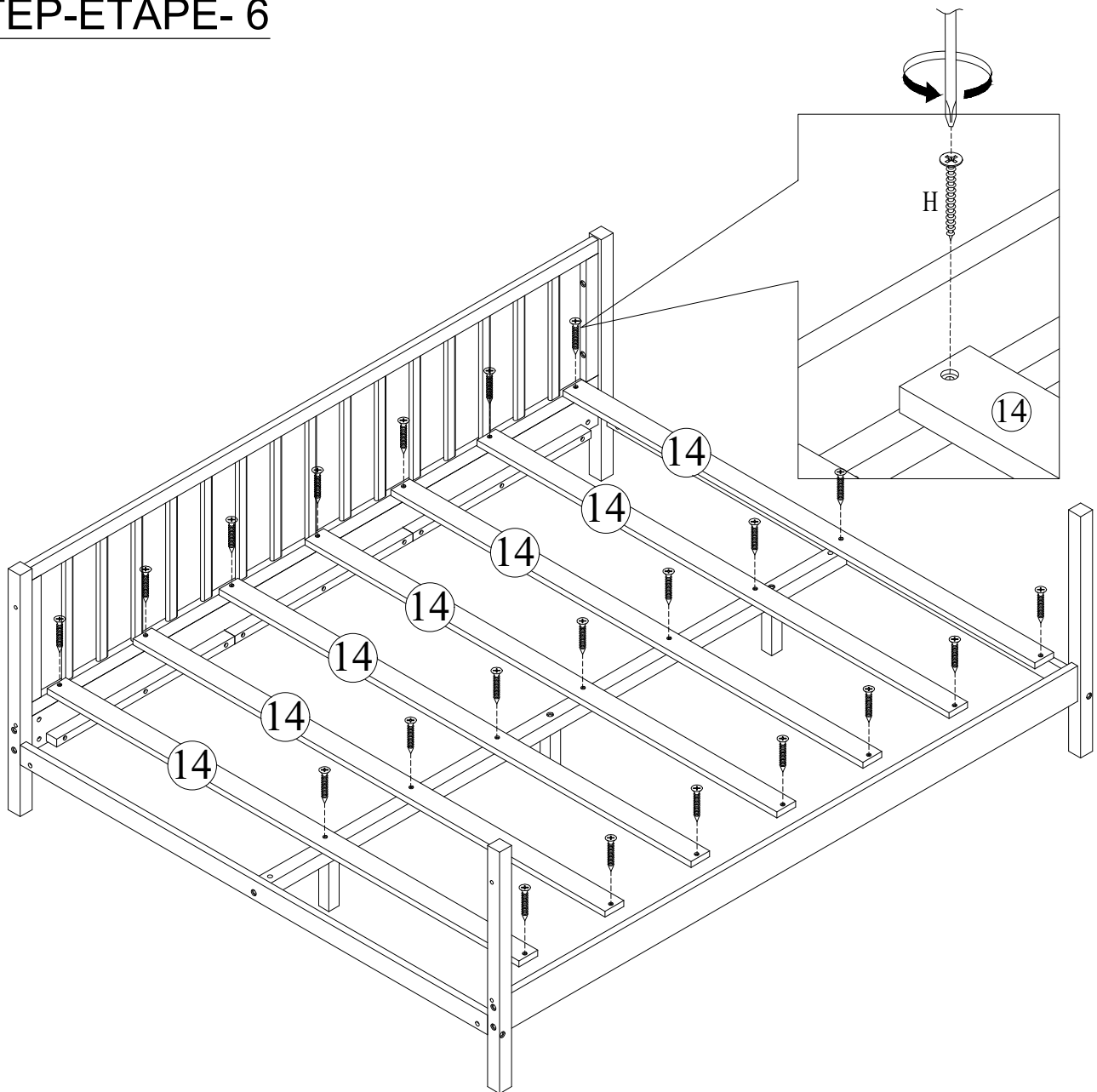

H
21PCS



NOTE: Please make sure the bed slats close to the side rail before locking the screws to avoid breakage. This step is required for both the left and right sides. Moreover, please do not lock the screws of the bed slats at the outermost edge to avoid damaging.

REMARQUE : Assurez-vous que les lattes du lit sont proches du rail latéral avant de verrouiller les vis pour éviter toute casse. Cette étape est nécessaire pour les côtés gauche et droit. De plus, ne verrouillez pas les vis des lattes du lit sur le bord le plus extérieur pour éviter de les endommager.

STEP-ÉTAPE-7

I		E	
	1PC		12PCS

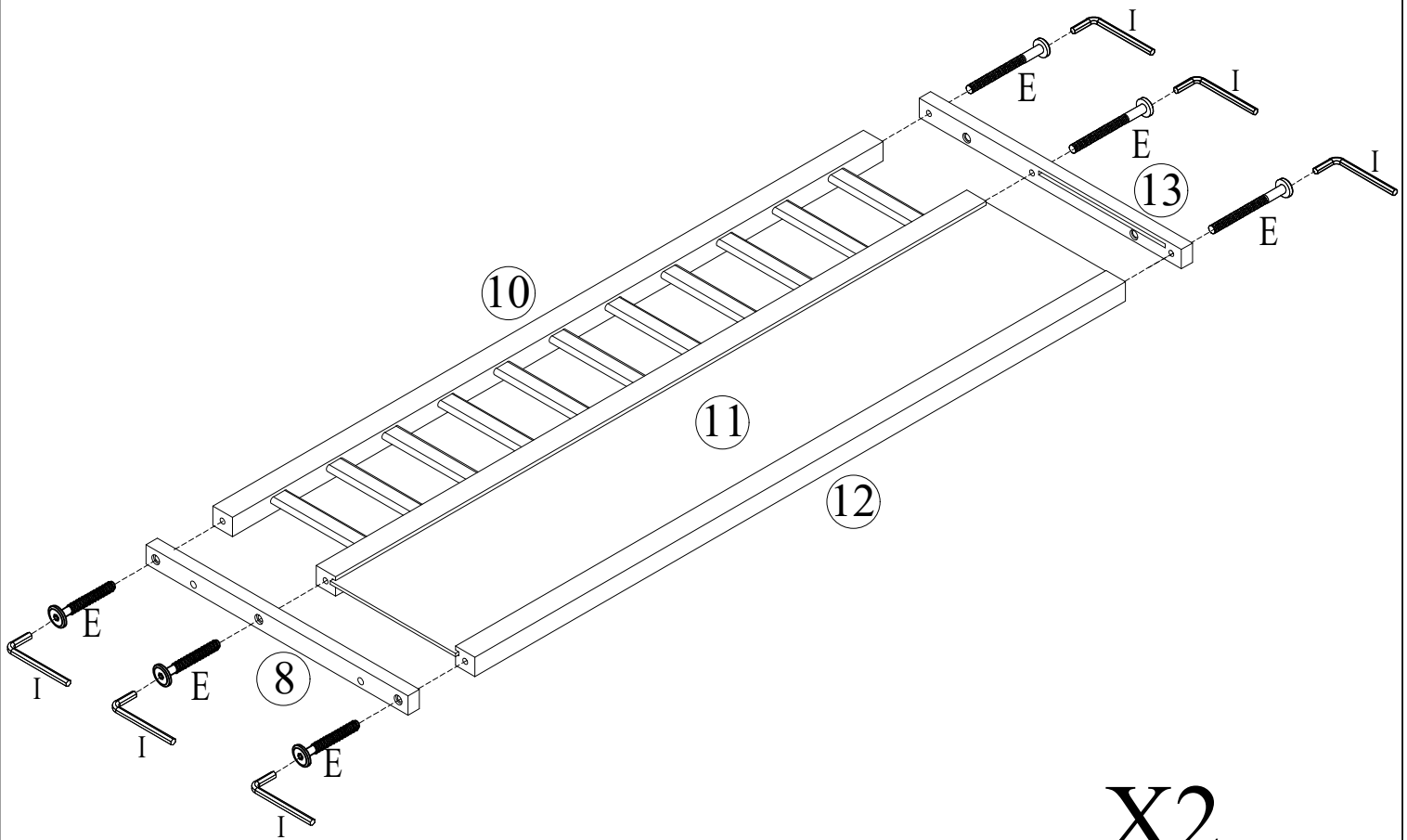
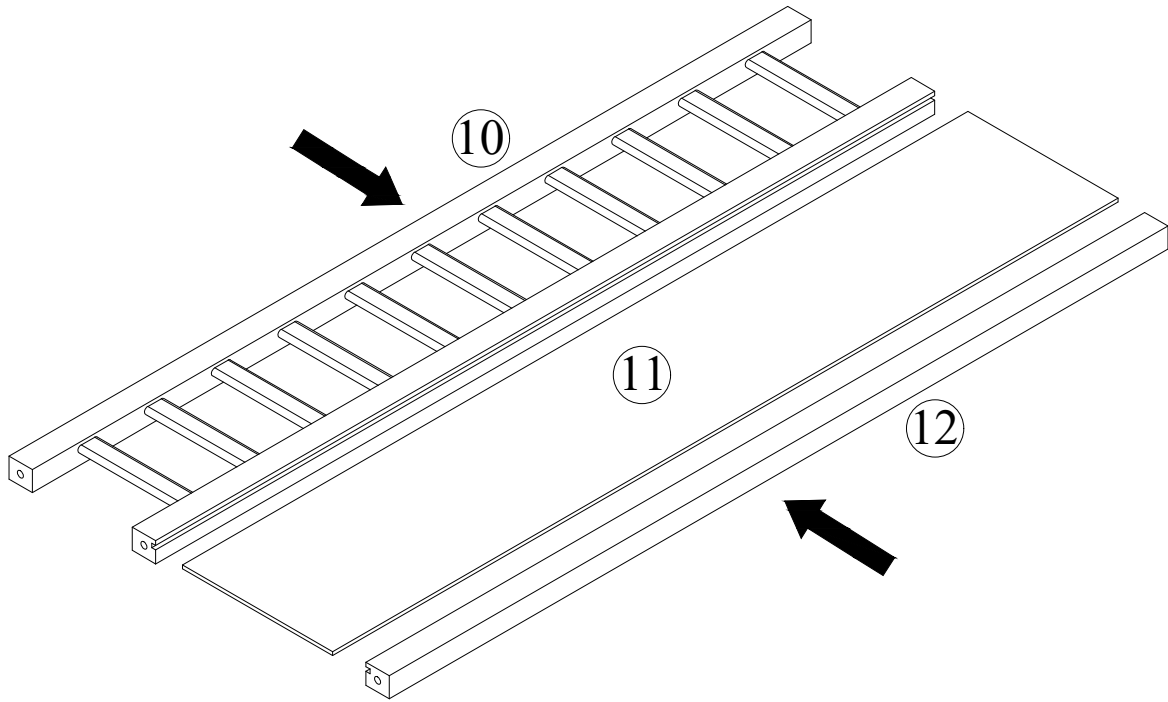

X2

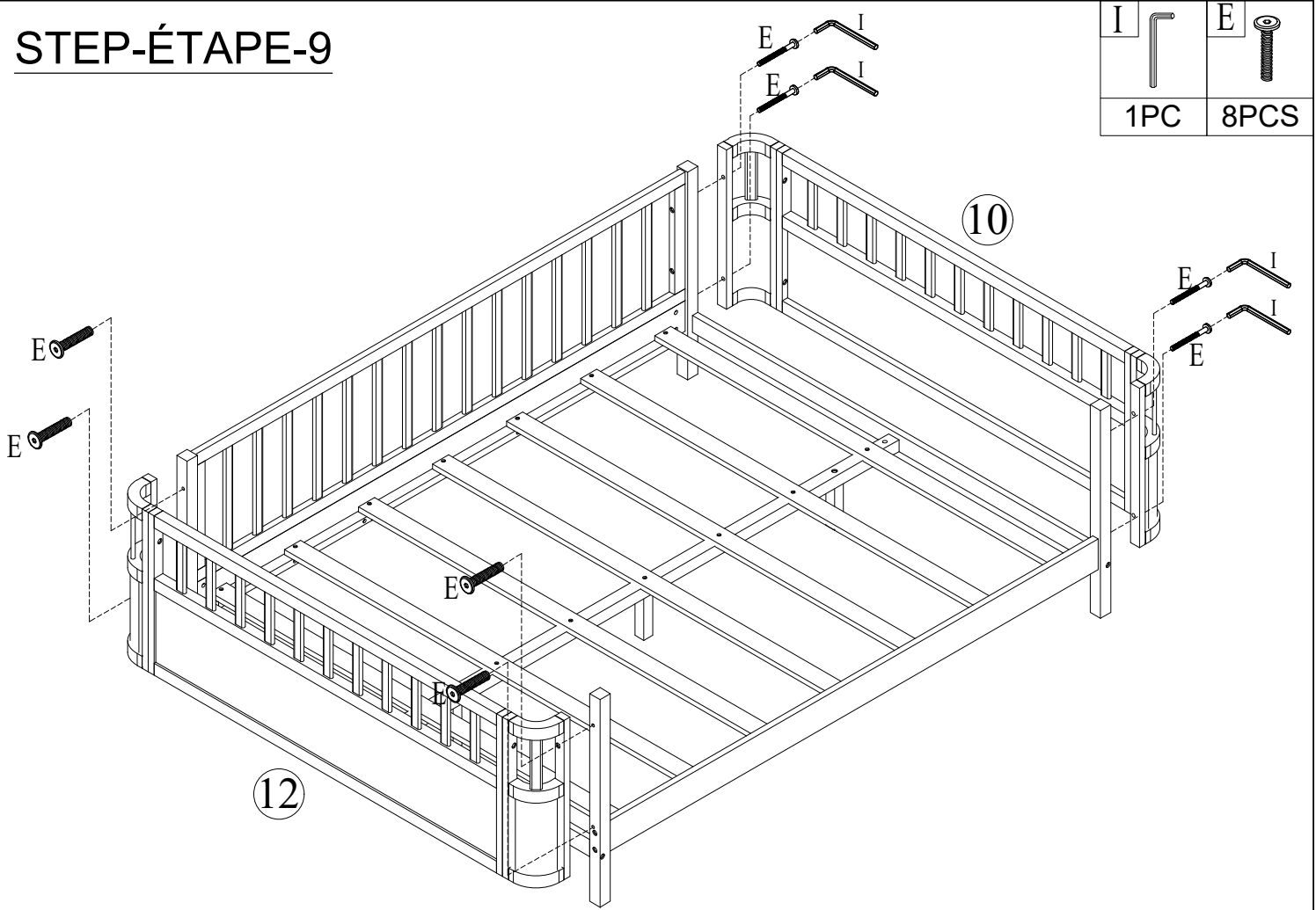

STEP-ÉTAPE-9

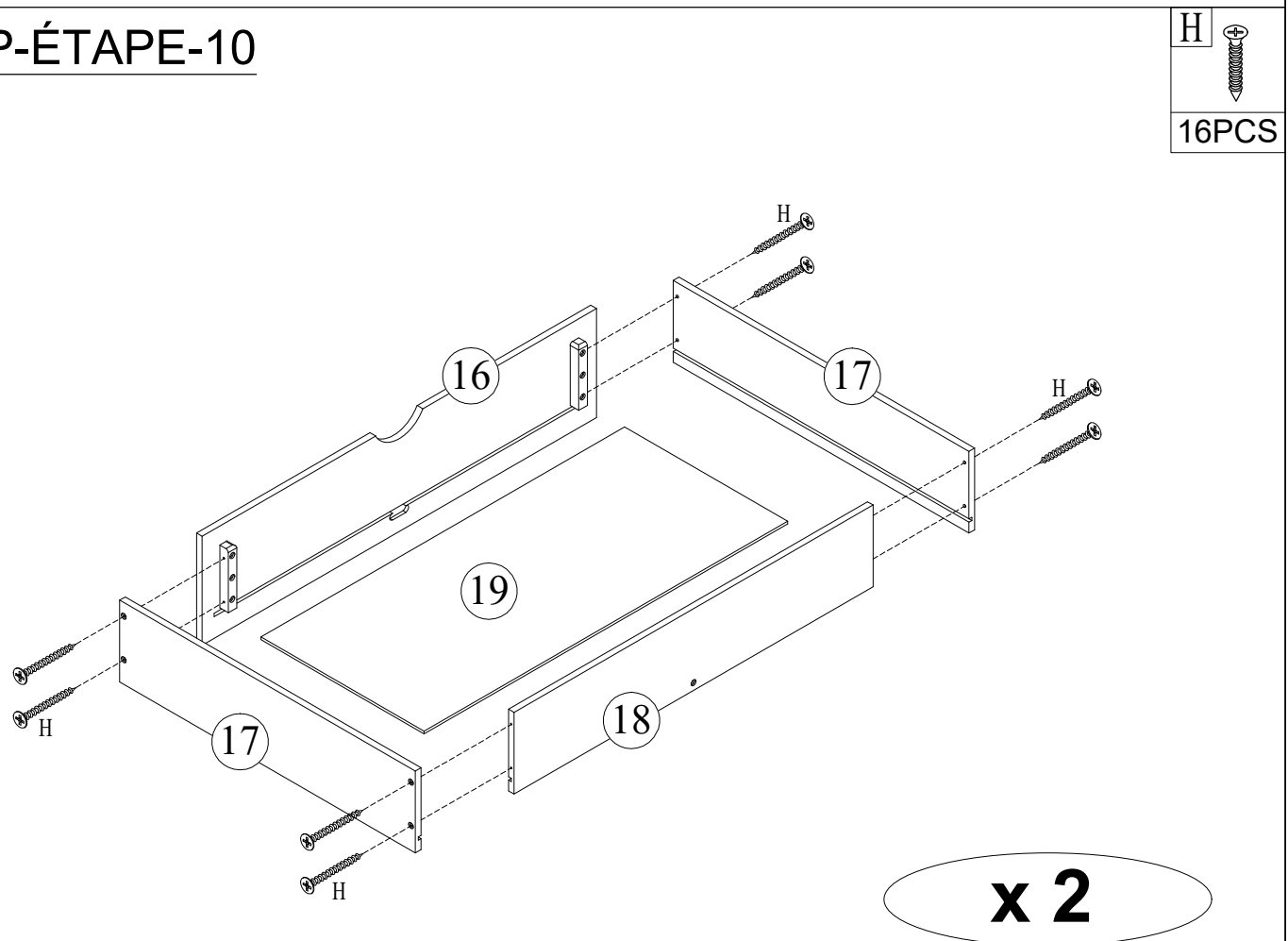

STEP-ÉTAPE-10



STEP-ÉTAPE-11

H		M		L	
2PCS		32PCS		8PCS	

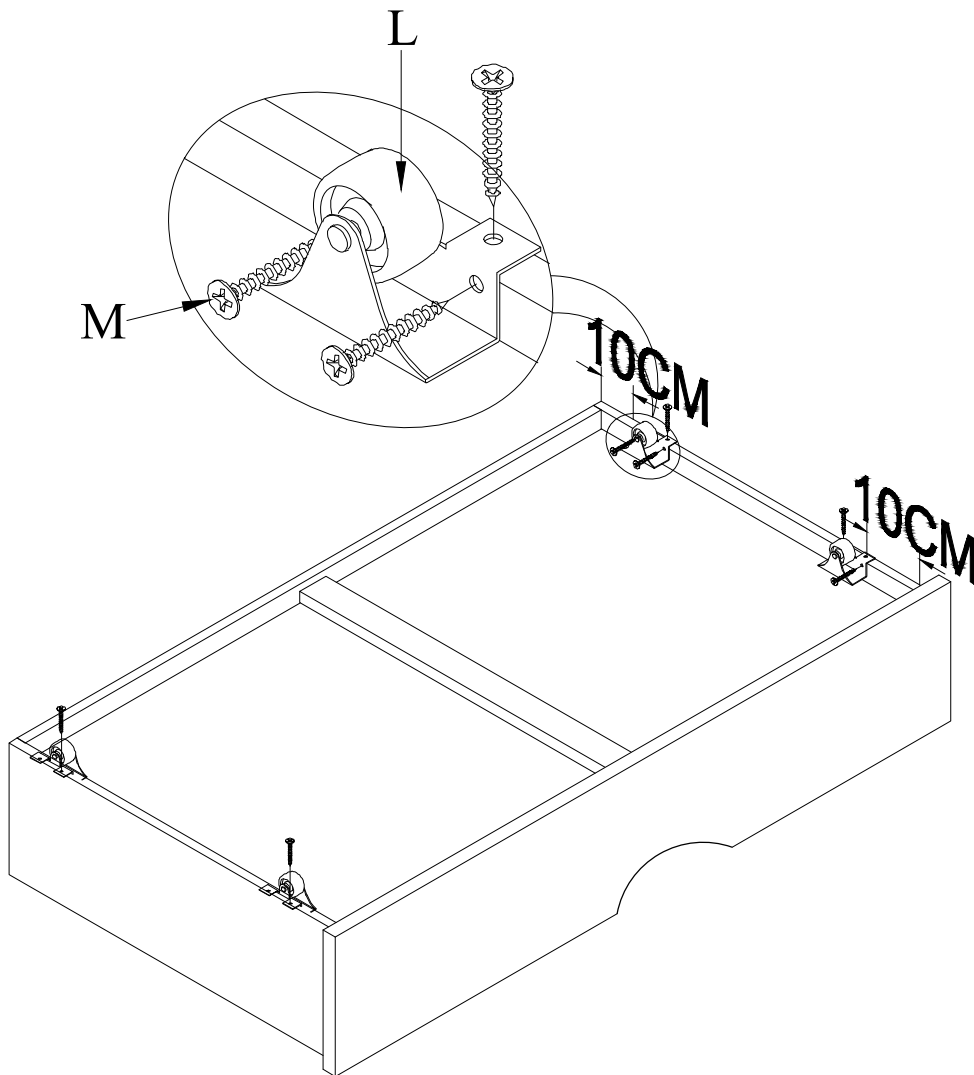
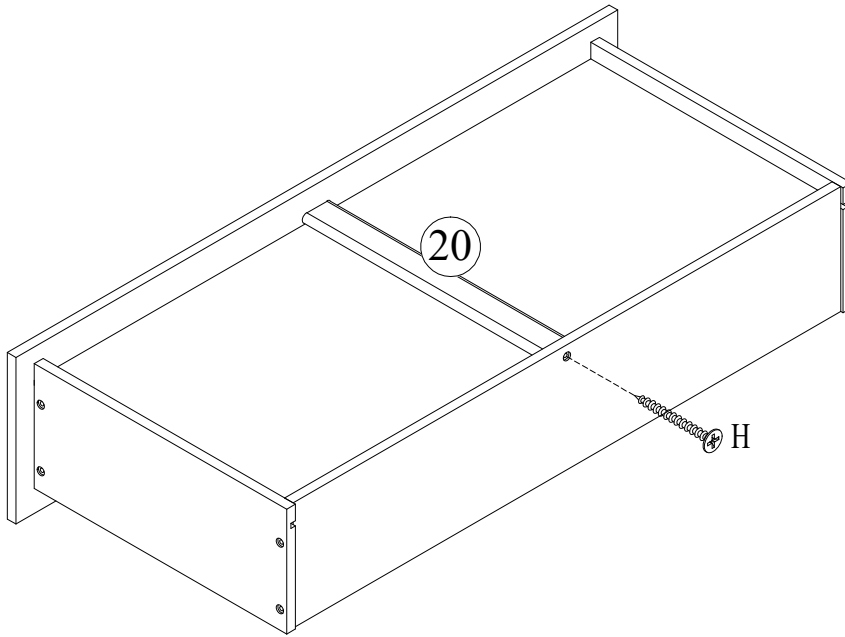

x 2

ASSEMBLY COMPLETED
ASSEMBLAGE TERMINÉ

