



GB WARNING! READ THE FOLLOWING BEFORE STARTING INSTALLATION

Only use your product when fully assembled as described in the instruction Book. If the product is damaged in any way stop using immediately and consult the store where you purchased your product for guidance.

We continually strive to improve our products, specifications may change without prior notice.

- Incorrect assembly can result in severe personal injury and property damage.
- Do not tilt chair or lean over the sides – always ensure all casters are firmly placed on a level surface.
- Children should not play with the chair.
- Do not lean over the arms. This could cause the product to become unbalanced and result injury.
- Always use the chair on a flat, stable surface to prevent injury.
- Do not stand on chair.
- If the damaged product is irreparable please dispose of the product. Using a damaged product may lead to personal injury.
- This appliance is intended for indoor household use.
- Only trained personnel can replace or repair seat height adjustment components with energy accumulators.
- Keep this instruction manual for future reference.

Check and make sure you get the components on the list, contact us for any missing

A Back Cushion x1

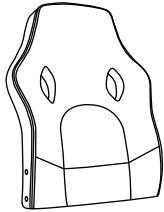

B Seat Cushion x1



C Seat Plate x1

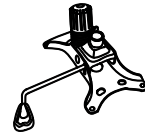

D Right Armrest x1

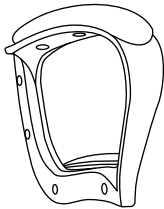

E Left Armrest x1

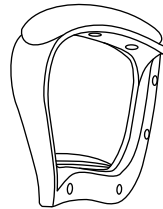

F Gas Lift x1



G Gas Lift Cover x1

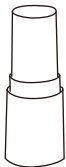

H Base x1

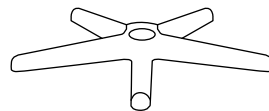

I Caster x5



J Screw(M6×20mm) x12



K Plastic Caps x8



L Allen Wrench(5mm)

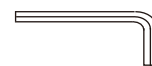

Installation step

1

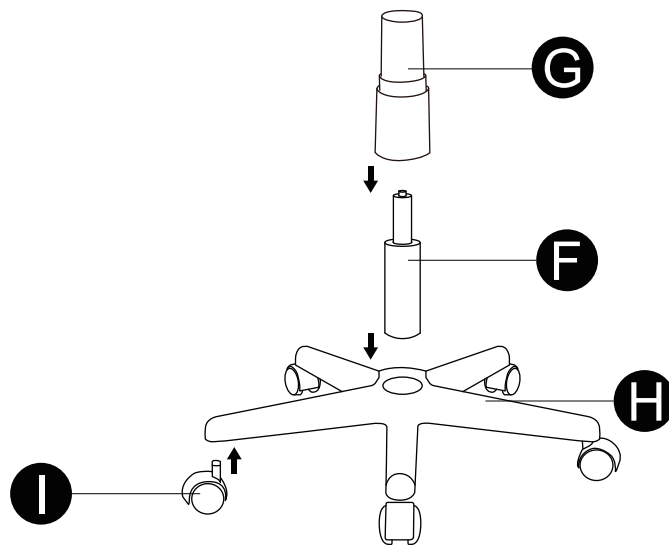

2

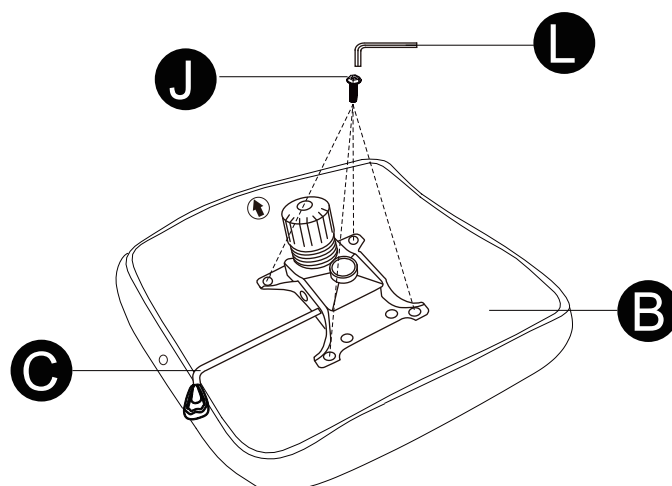

3

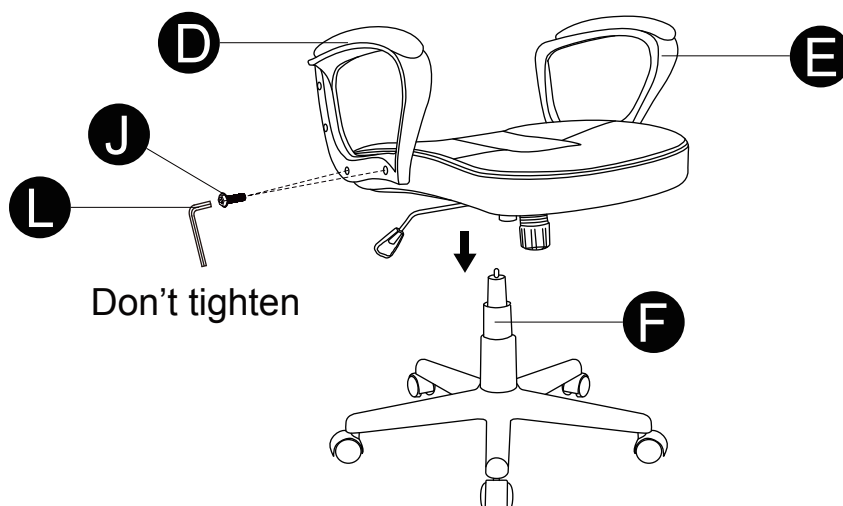

4

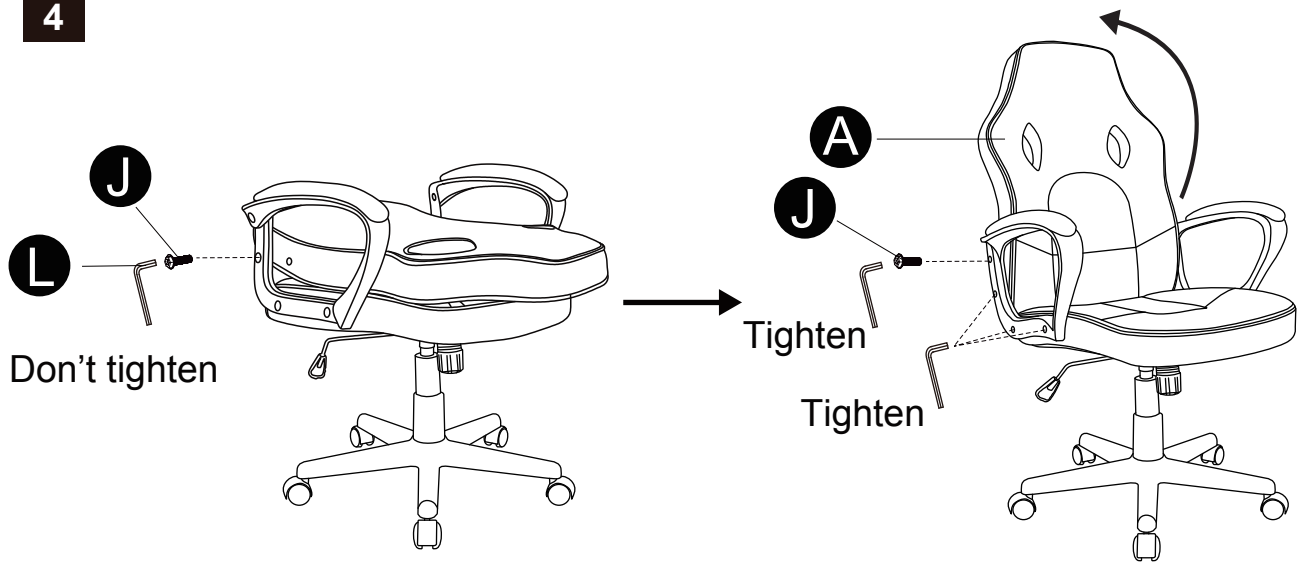

5

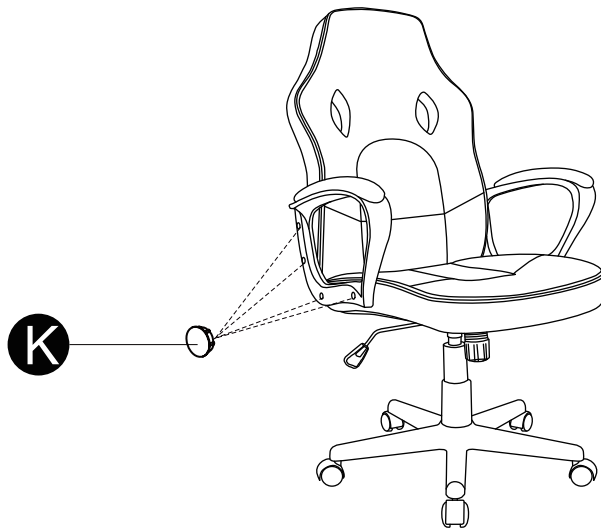

6





110 kg

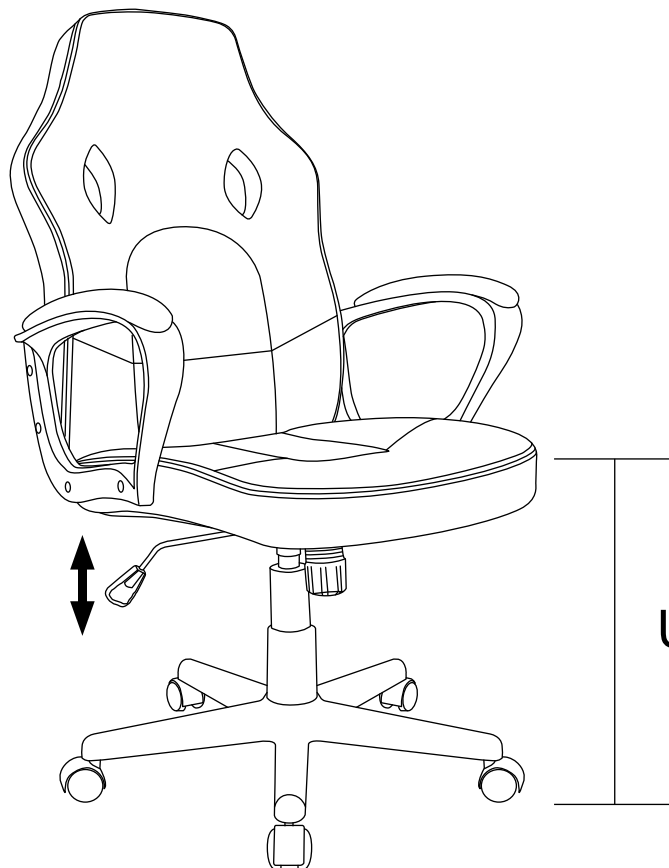

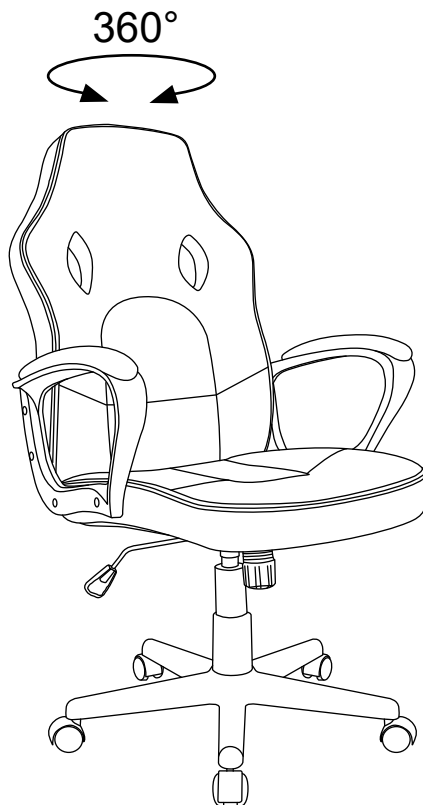
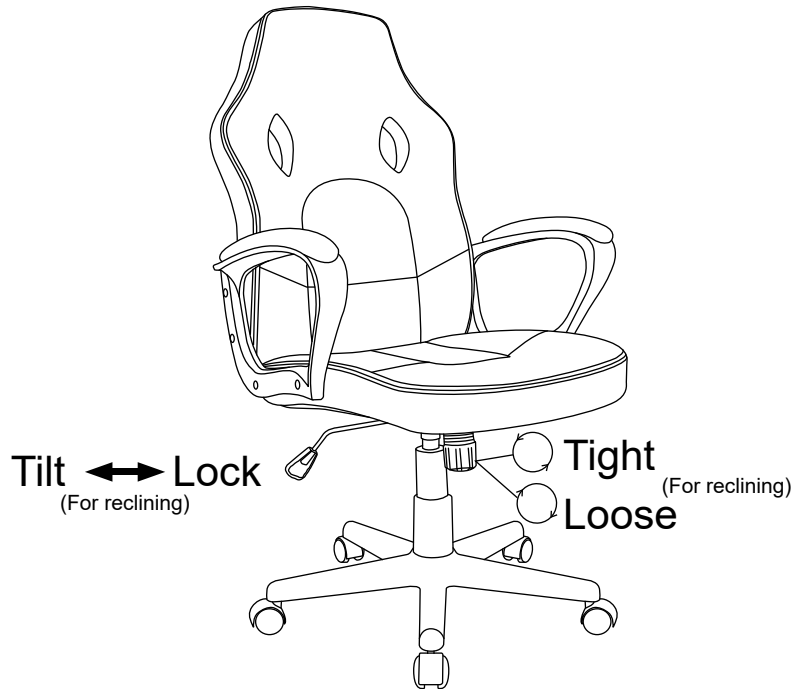



GB WARNUNG! LESEN SIE DAS FOLGENDE, BEVOR SIE INSTALLIEREN.

Verwenden Sie Ihr Produkt nur, wenn es wie im Handbuch beschrieben vollständig montiert ist. Wenn das Produkt auf irgendeine Weise beschädigt ist, stoppen Sie sofort und wenden Sie sich an das Geschäft, in dem Sie Ihr Produkt gekauft haben.

Wir sind ständig bemüht, unsere Produkte zu verbessern. Und sie können ohne vorherige Ankündigung geändert werden.

- Eine falsche Montage kann zu schweren Verletzungen und Sachschäden führen.
- Kippen Sie den Stuhl nicht und lehnen Sie sich nicht über die Seiten - stellen Sie immer sicher, dass alle Rollen fest auf einer ebenen Fläche platziert sind.
- Kinder sollten nicht mit dem Stuhl spielen.
- Beugen Sie sich nicht über die Arme. Dies kann dazu führen, dass das Produkt unausgewogen wird, was zu Verletzungen führen werden.
- Verwenden Sie den Stuhl immer auf einer ebenen und stabilen Oberfläche, um Verletzungen zu vermeiden.
- Stehen Sie sich nicht auf einen Stuhl.
- Wenn das beschädigte Produkt irreparabel ist, entsorgen Sie es bitte. Die Verwendung eines beschädigten Produkts kann zu Verletzungen führen.
- Dieses Gerät ist für den Innenhaushalt geeignet.
- Nur geschultes Personal kann Sitzhöhenverstellkomponenten durch Energiespeicher ersetzen oder reparieren.
- Bewahren Sie dieses Handbuch für späteren Nachschlagen auf.

Überprüfen Sie, ob Sie alle Komponenten in der Liste erhalten, und kontaktieren Sie uns, wenn etwas fehlt.

A Rückenkissen x1

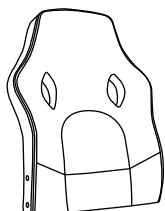

B Sitzkissen x1



C Sitzplatte x1

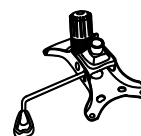

D Rechte Armlehne x1

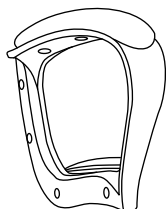

E Linke Armlehne x1

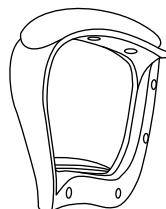

F Gaslift x1



G Gasliftabdeckung x1

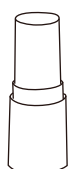

H Basis x1

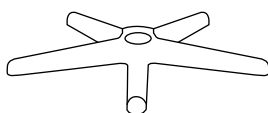

I Castor x5



J Schraube(M6×20mm) x12



K Kunststoffkappen x8



L Inbusschlüssel(5mm)

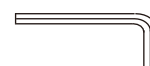

Installationsschritt

1

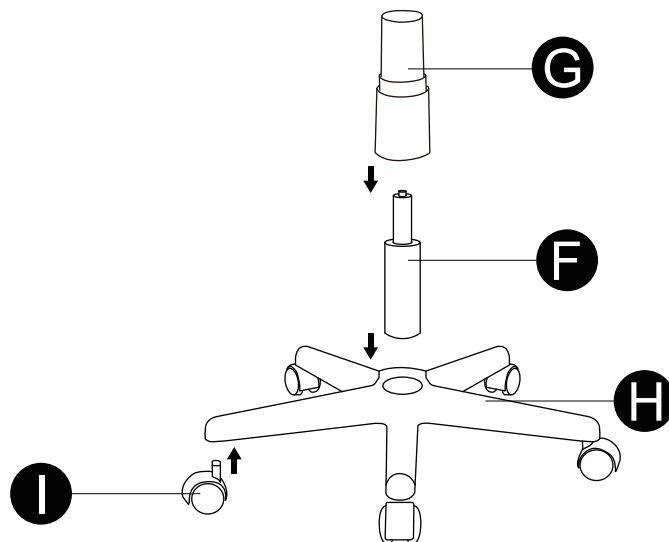

2

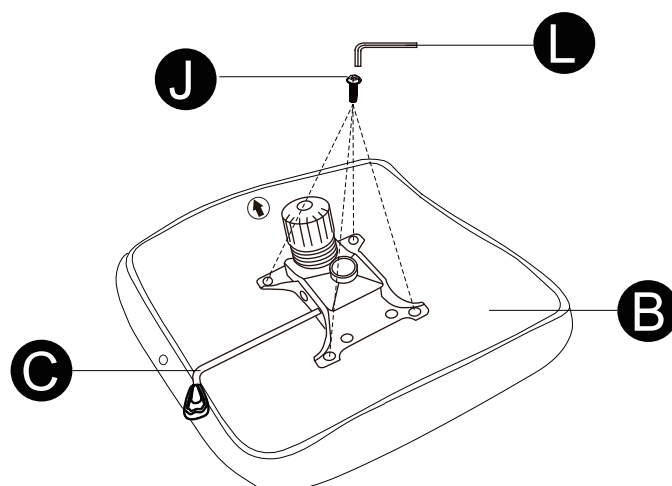

3

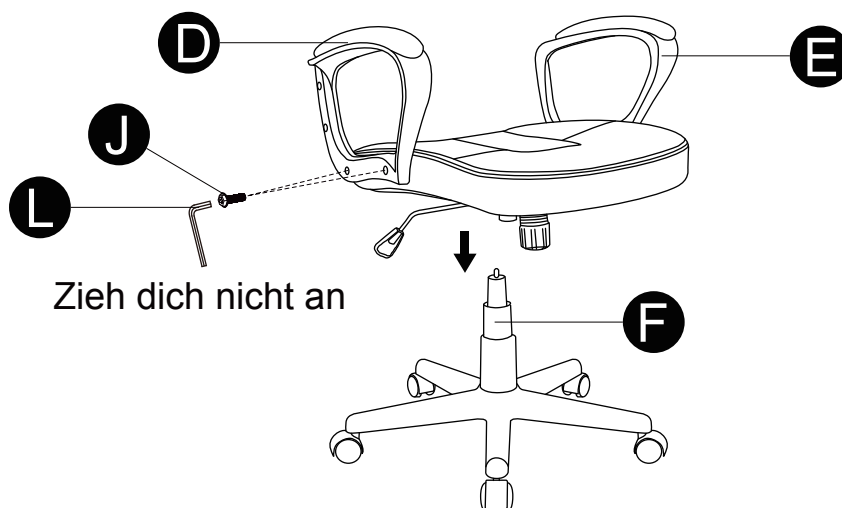

Installationschritt

4

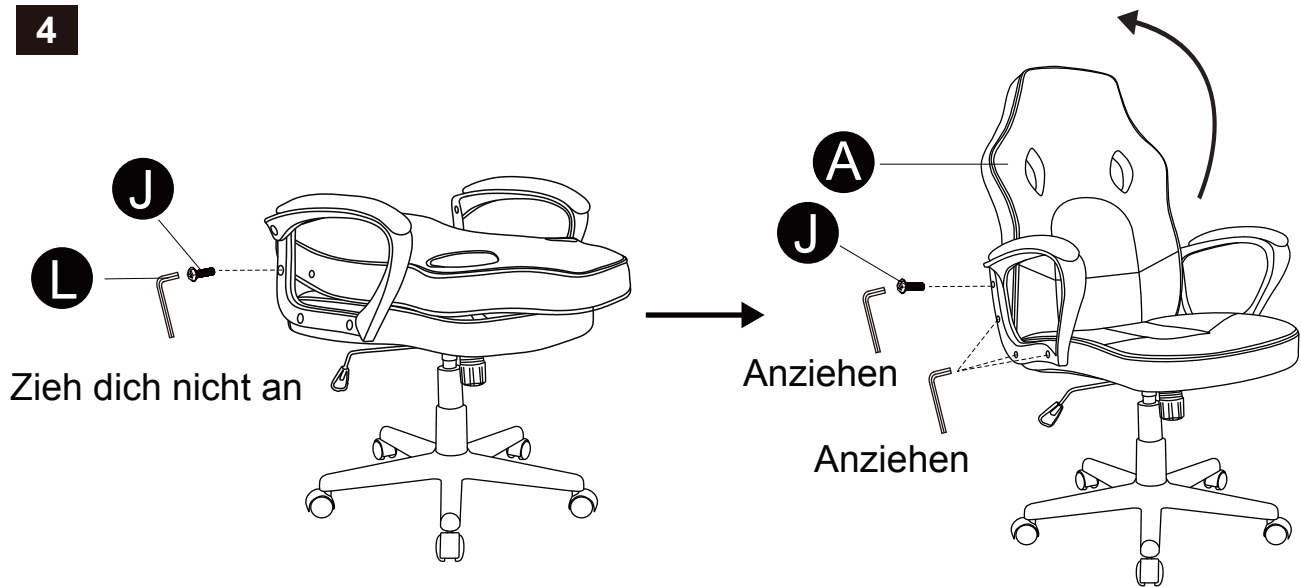

5

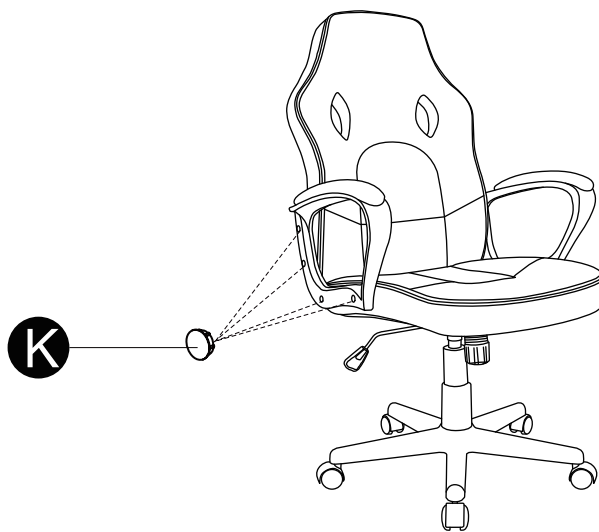

6





110 kg

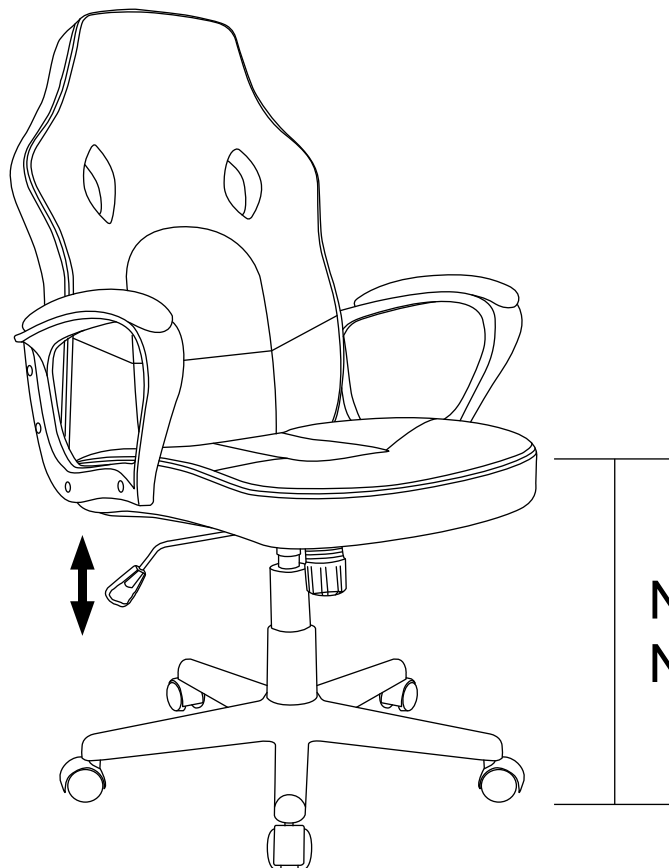

Nach oben &
Nach unten

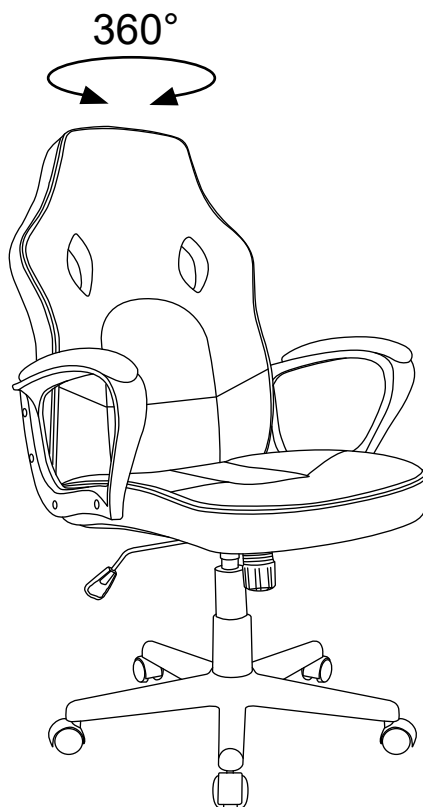
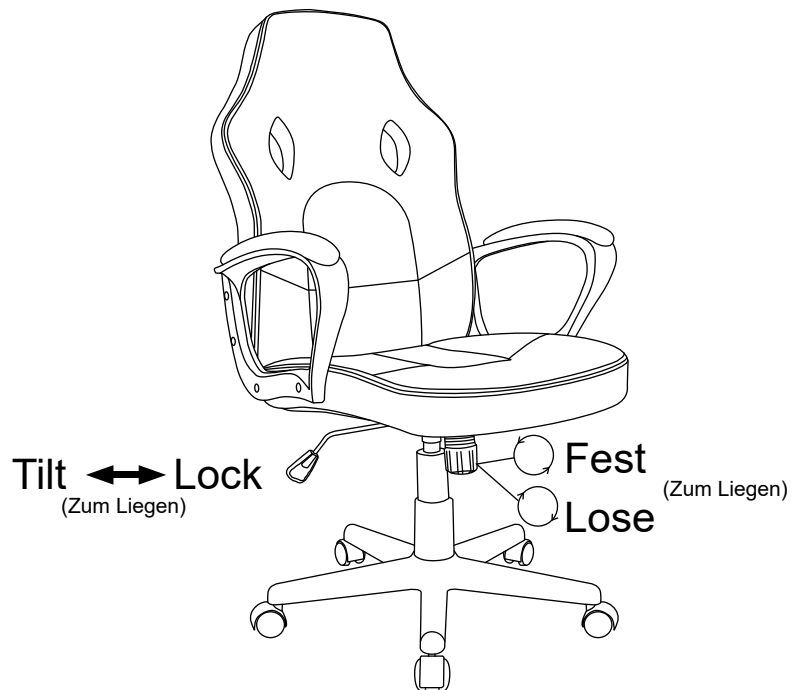



GB AVERTISSEMENT! LISEZ CE QUI SUIT AVANT DE COMMENCER L'INSTALLATION

Utilisez uniquement votre Dproduct une fois assemblé comme décrit dans le manuel d'instructions. Si le produit est endommagé De quelque façon que ce soit, arrêtez-nous immédiatement et consultez le magasin où vous avez acheté votre produit pour obtenir des conseils.

Nous nous efforçons continuellement d'améliorer nos produits, les spécifications peuvent changer sans préavis.

- Un assemblage incorrect peut entraîner des blessures graves et des dommages matériels.
- N'inclinez pas la chaise et ne vous penchez pas sur les côtés - assurez-vous toujours que toutes les roulettes sont fermement placées sur une surface plane.
- Les enfants ne doivent pas jouer avec la chaise.
- Ne vous penchez pas sur les bras. Cela pourrait entraîner un déséquilibre du produit et entraîner des blessures.
- Utilisez toujours le fauteuil sur une surface plane et stable pour éviter les blessures.
- Ne vous tenez pas sur la chaise.
- Si le produit endommagé est irréparable, veuillez jeter le produit. L'utilisation d'un produit endommagé peut entraîner des blessures.
- Cet appareil est destiné à un usage domestique intérieur.
- Seul le personnel qualifié peut remplacer ou réparer les composants de réglage de la hauteur du siège avec des accumulateurs d'énergie.
- Conservez ce manuel d'instructions pour référence ultérieure.

Vérifiez et assurez-vous d'obtenir les composants sur la liste, contactez-nous pour tout manquant

A Coussin dossier x1

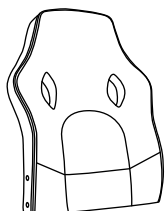

B Coussin de siège x1



C Plaque de siège x1

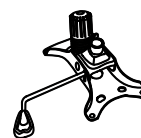

D Accoudoir droit x1

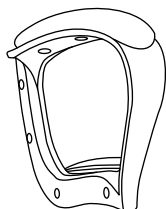

E Accoudoir gauche x1

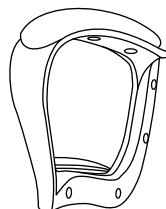

F Ascenseur à gaz x1



G Couvercle de vérin à gaz x1

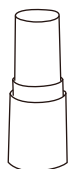

H Base x1

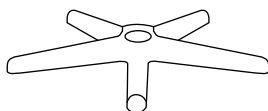

I Roulette x5



J Vis (M6×20mm) x12



K Bouchons en plastique x8



L Clé Allen (5mm)



Étapes d'installation

1

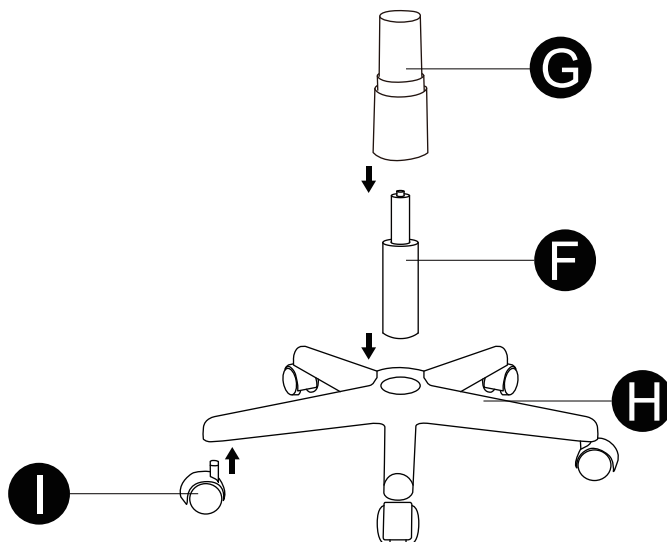

2

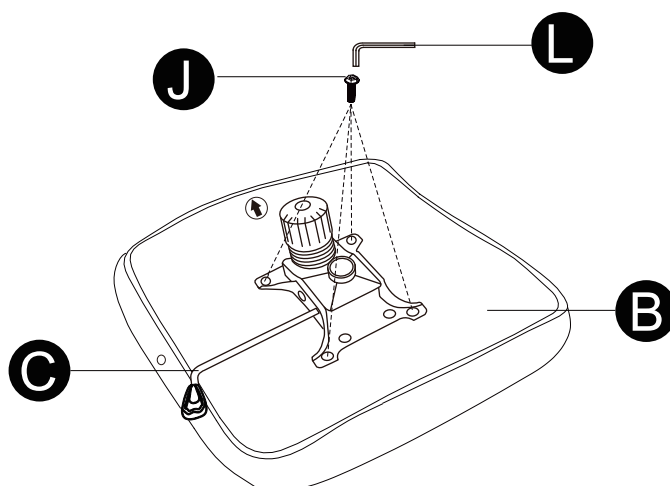

3

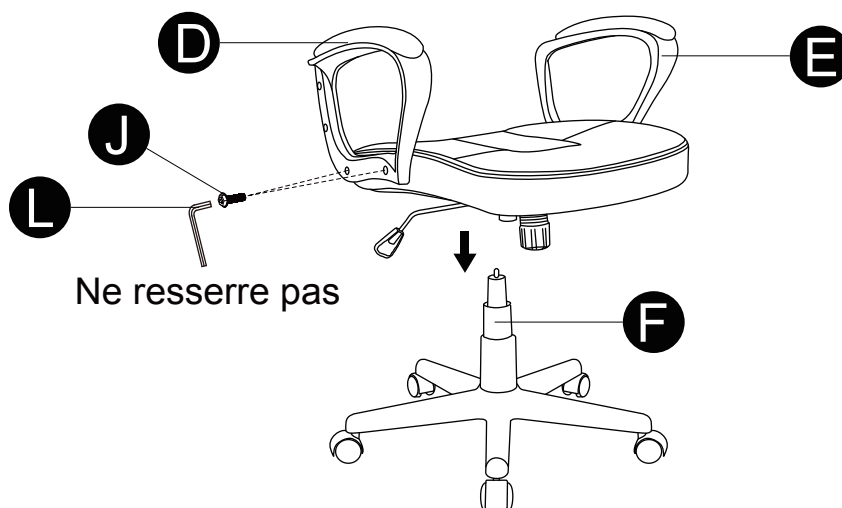

Étapes d'installation

4

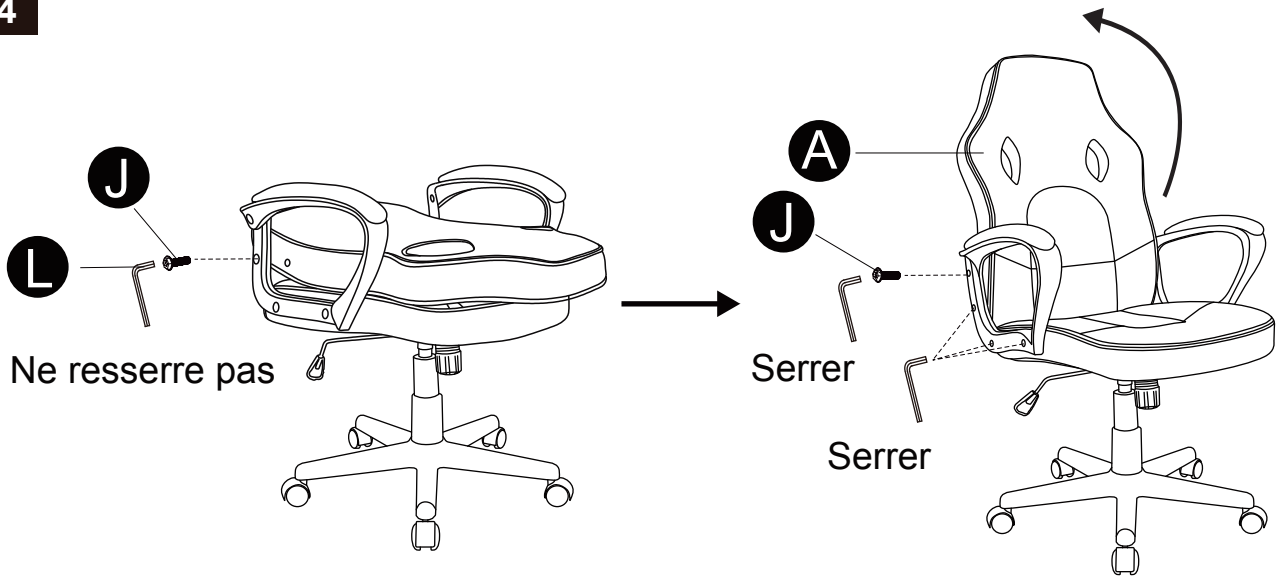

5

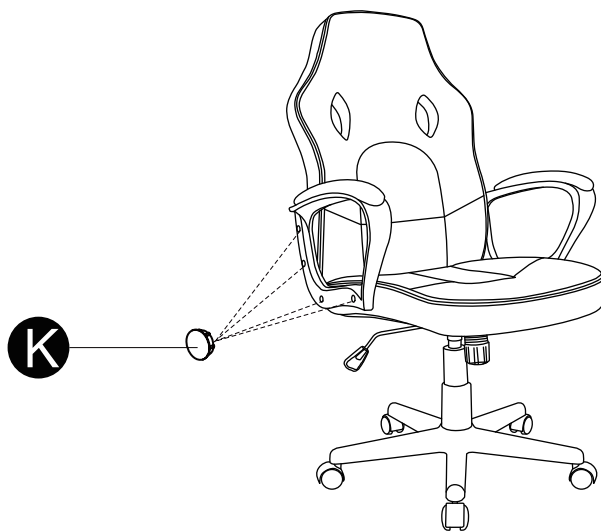

6



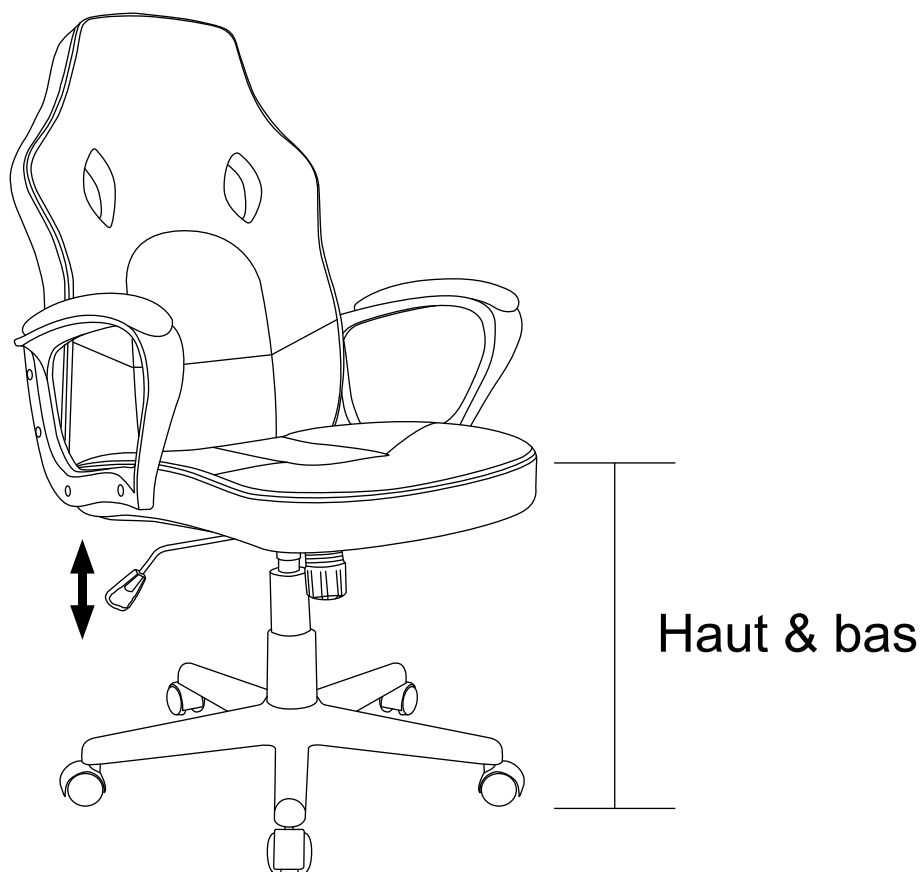
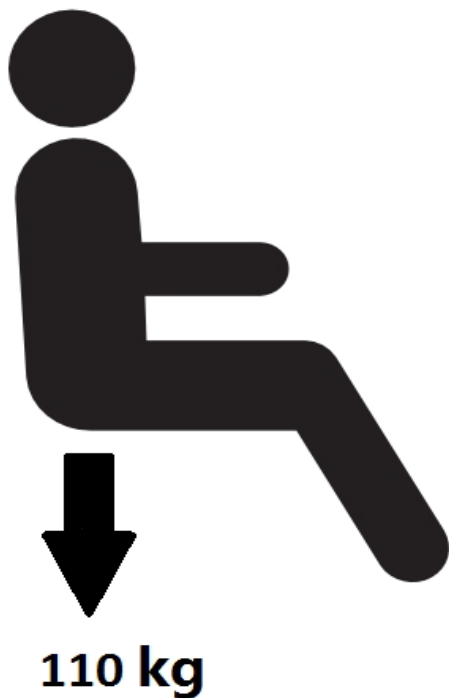



Til Inclinaison



Verrouillage

(Pour inclinable)

Serrez
(Pour inclinable)
Desserrez



360°