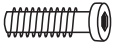





Table Assembly Instructions

Hardware Included

1	TOP PANEL		1 PC	B	8x45 BOLT		8 PCS
2	LEG		4 PCS	C	8x19 SPRING WASHER		8 PCS
A	ALLEN KEY M5		1 PC	D	M8 FLAT WASHER		8 PCS

Do not fully tighten screws until completely assembled.

STEP 1

Insert each leg in its corresponding marked leg hole, and using Allen key tighten the bolts

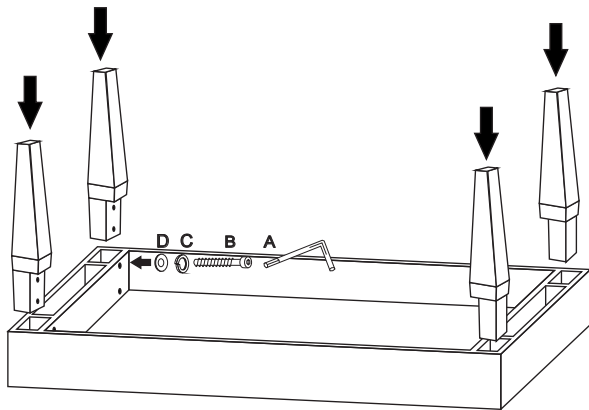

STEP 2

Carefully lift the table, turning it around once it is off the ground in order to prevent breaking/cracking the mirrors.

