

# ASSEMBLY INSTRUCTION

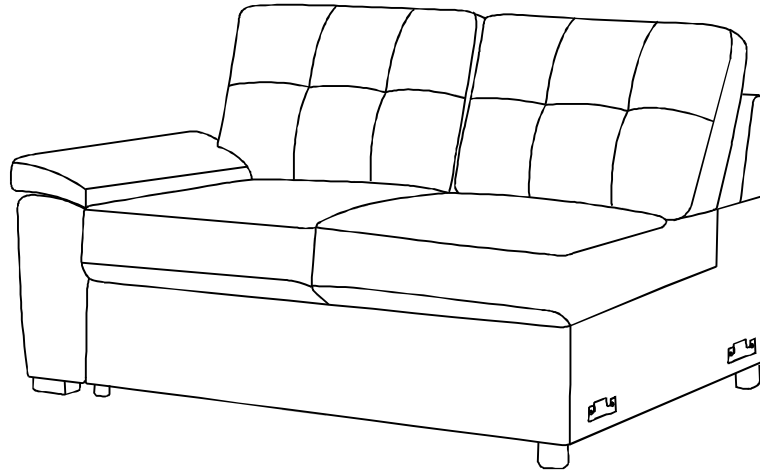

## PARTS LIST

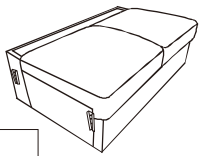

**A**

x1

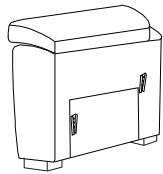

**B**

x1

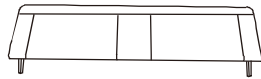

**C**

x1

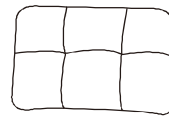

**D**

x1

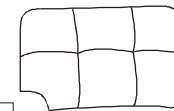

**E**

x1

## HARDWARE LIST



**1**

x4

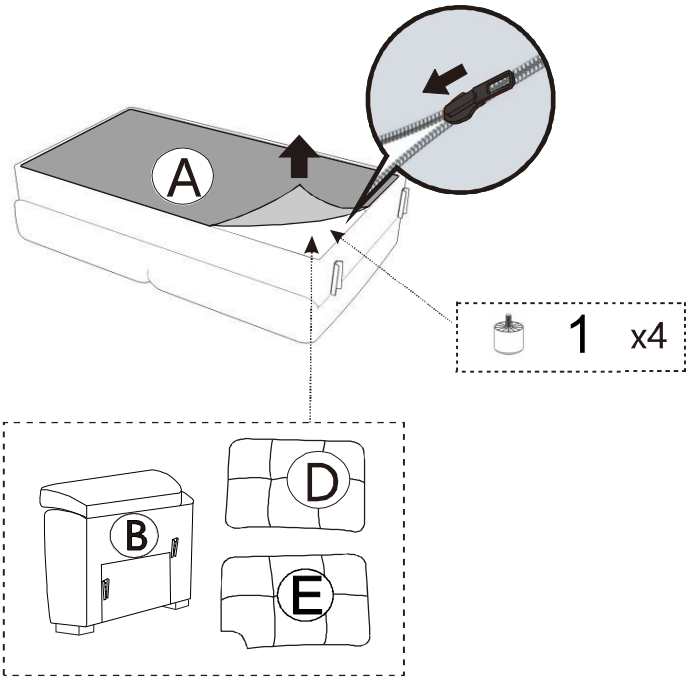

### Step1

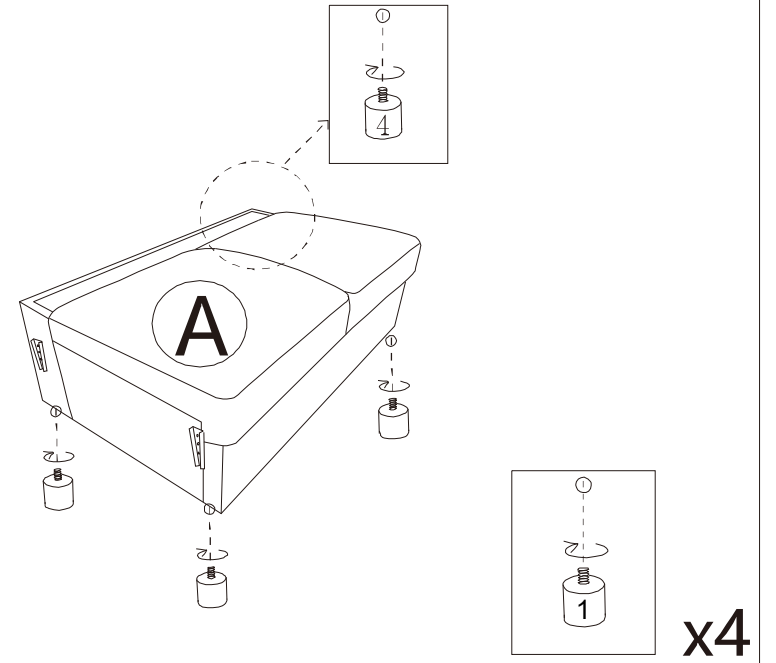

### Step2

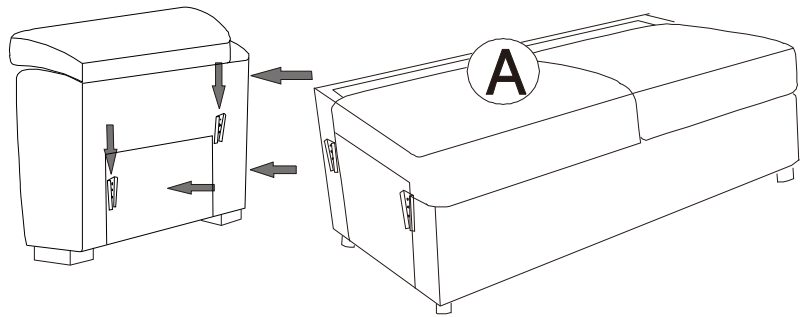

### Step3

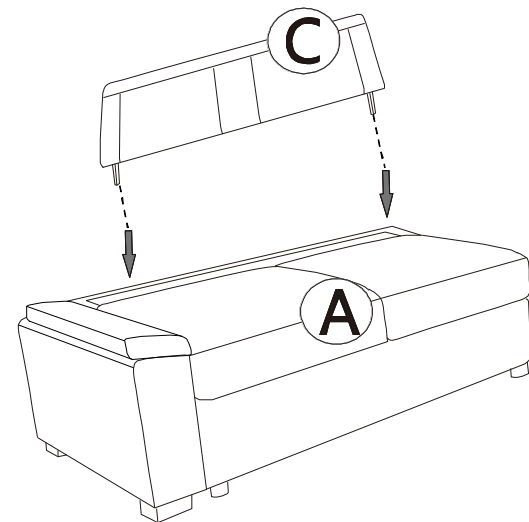

### Step4

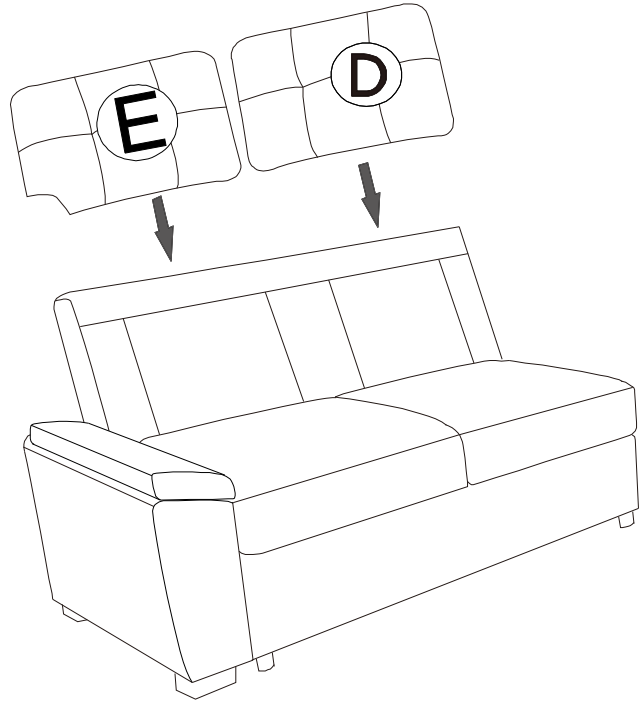

### Step5

