

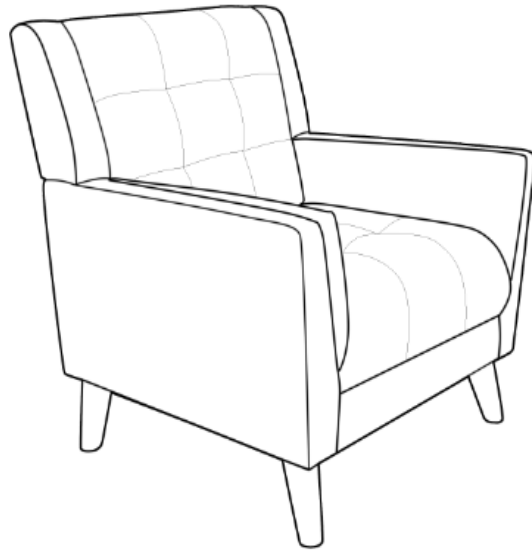



Assembly Instructions

Caution: You must read this before you proceed





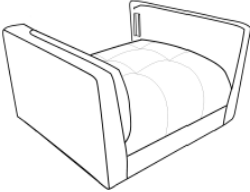
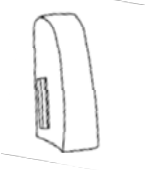

Club Chair



Parts List

Label	Picture	Description	QTY
A		Backrest Panel	1
B		Seat Base	1
C		Wing	2
D		Leg	4

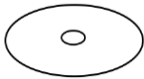

Hardware

Label	Picture	Description	QTY
①		Bolt (M8x35mm)	13
②		Spring Washer	13
③		Washer	13
④		Bolt (M8x60mm)	2
⑤		Washer	2
⑥		Allen Key	1

Assembly Preparation

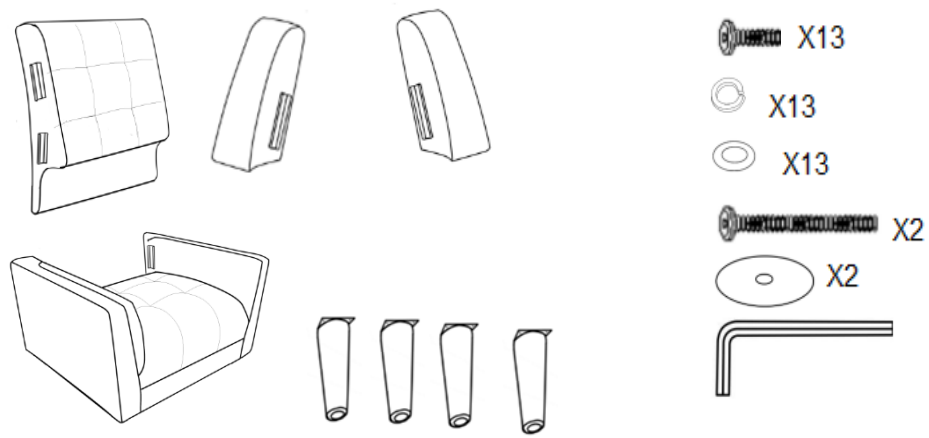
Before Beginning Assembly:



-  • Read instructions, cover to cover-
-  • Have 2 adults on hand for assembly-
- 



- Do not assemble on flooring or carpet-



- Assemble on a clean non-marring surface (packing foam)-



- Save all packaging until finished-

Assembly Steps

Overview

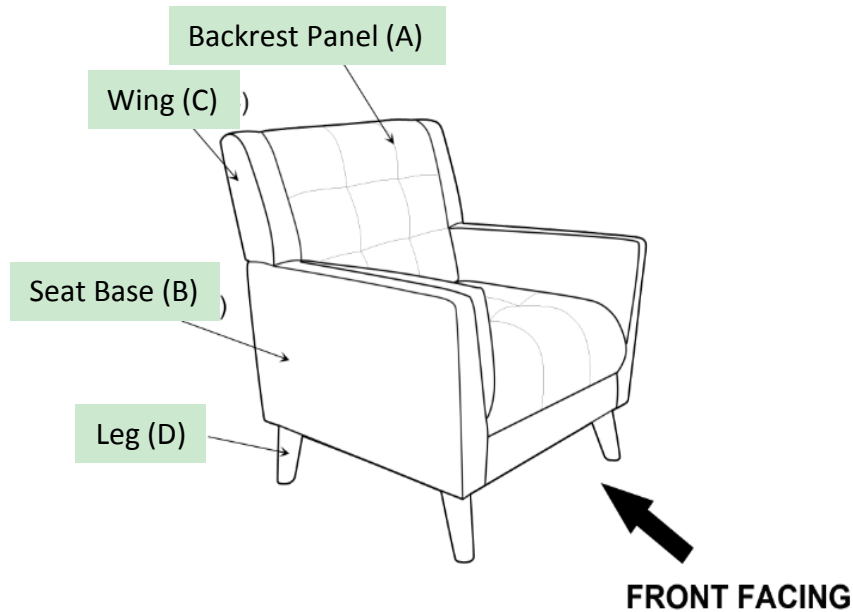

This Club Chair has multiple parts and may require up to 30 minutes to assemble. To give you an overview of the Club Chair parts, the above picture is to help you put the various parts into perspective. Please read through the instructions below to familiarise yourself with the parts and steps before assembly.

Step 1

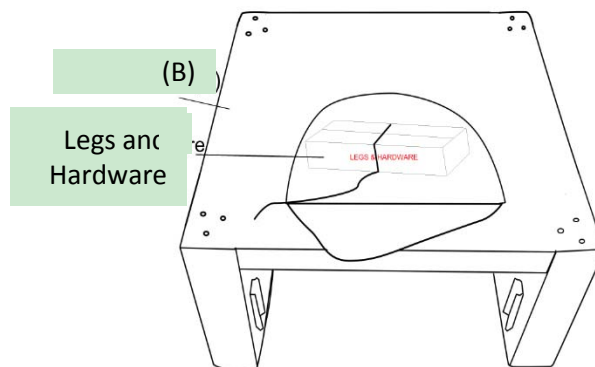

With Assistance from your adult partner, position the Seat Base(B) facedown on a clean, non-marring surface, as shown. Upzip the pouch and remove the Legs(D) and Hardware. Close the pouch.

Step 2

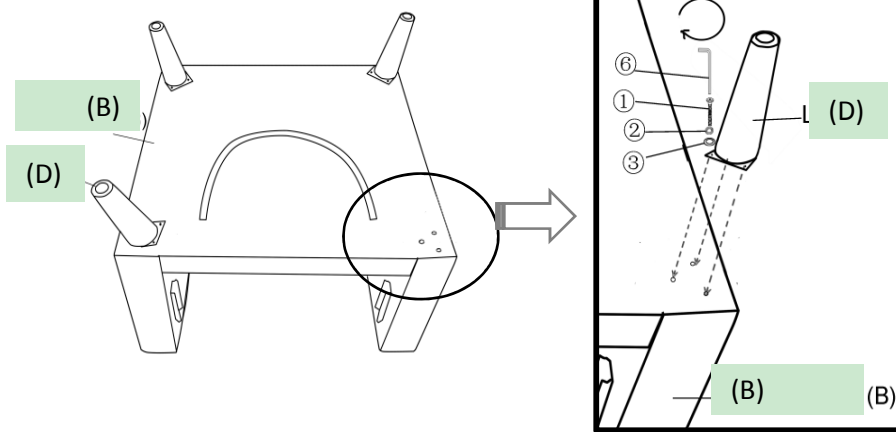

Attach Legs(D) to Seat Base(B) using Bolts(①), Spring Washers(②), and Washers(③) with Allen Key(⑥).

Do not fully tighten the Bolts.

Step 3

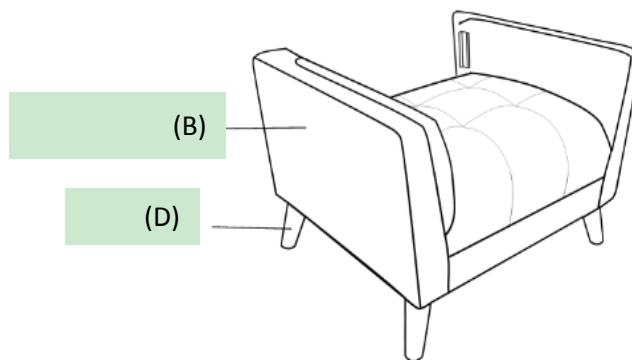

Stand the Seat Base(B) up.

Step 4

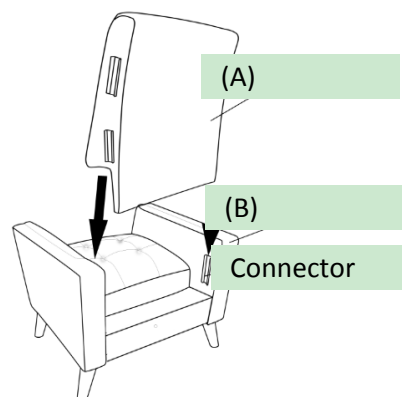

With assistance from your adult partner, lift the Backrest Panel(A) and insert the Connectors on the Backrest Panel(A) into the Connectors on the Seat Base(B).

Push firmly down on Backrest Panel(A) to ensure it is fully locked into position.

Step 5

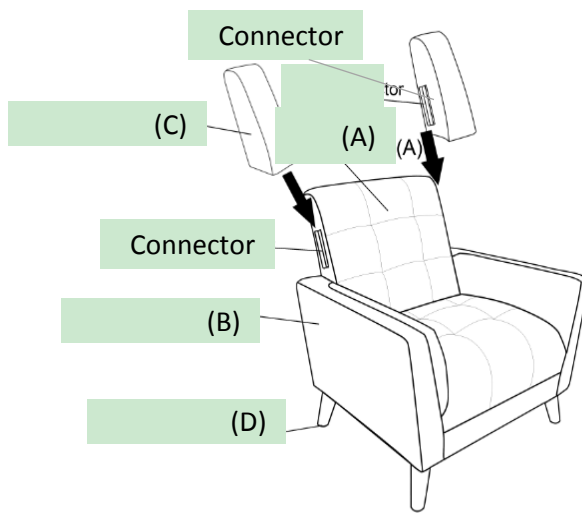

Insert the Connectors on the Wings(C) into the Connectors on the Backrest Panel(A).
Push firmly down on Wings(C) to ensure they are fully locked into position.

Step 6

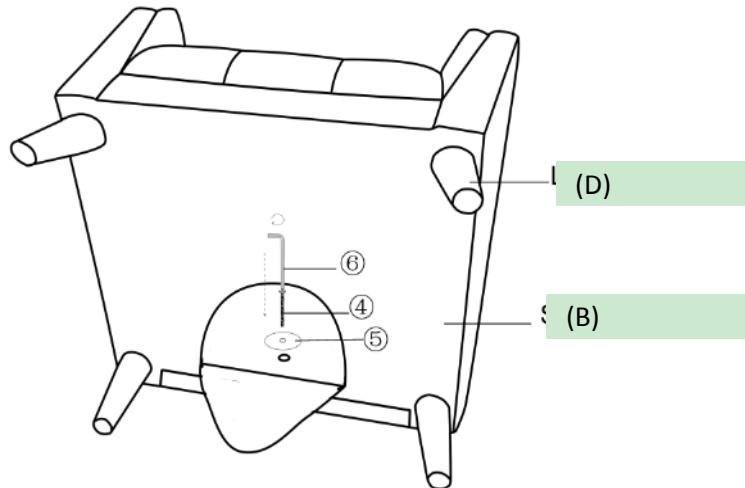

Upzip the pouch at the bottom of Seat Base(B).
Attach Backrest Panel(A) and Seat Base(B) by using Bolt(④) and Washer(⑤) with Allen Key(⑥).
Tighten the Bolts fully in a sequential manner.
Then close the pouch.

Step 7

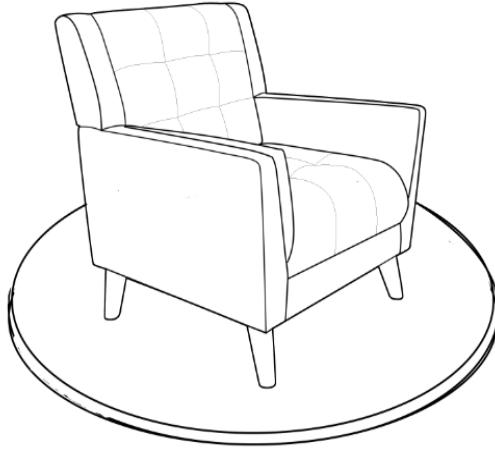

Stand the Club Chair up.

Place the Club Chair on a **LEVEL SURFACE**.

Inspect it and make sure all parts are adequately connected.

Gently and carefully, sit on the Club Chair.

This pressure will help the Legs and Seat Base reach full alignment status.

Then get off the Club Chair and carefully place the Club Chair facedown.

Then proceed to tighten all Bolts at all joints in a sequential manner.

If there are still wobbles, loosen the Bolts and execute the same process.



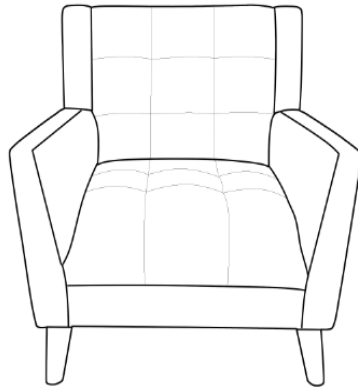

















Step 8



Your Club Chair is ready for use.

This Club Chair can only be used on a flat, level surface.

Care & Maintenance

-   ● Do not put hot items directly on furniture surface
 -   ● Do not clean furniture with harsh cleansers or polish.
 -   ● Do not place furniture under direct sunlight.
 -   ● Do not place furniture near heating or cooling vents.
 -   ● Do not write on furniture without a padded barrier to protect the surface.
 -   ● Do not place furniture outside . For indoor use only .
 -   ● Not for commercial use. For residential use only .
 -   ● Stains may be removed with mild soap solution and damp cloth.
 -   ● Children should not climb or jump on the furniture.
-
-   ● Dust and pick-up spills using a clean, non-colored, lint-free cloth .

Questions & Answers about Proposition 65

- What is Proposition 65?

Proposition 65 requires businesses to provide warnings to Californians about significant exposures to chemicals that cause cancer, birth defects or other reproductive harm. These chemicals can be in the products that Californians purchase, in their homes or workplaces, or that are released into the environment. By requiring that this information be provided, Proposition 65 enables Californians to make informed decisions about their exposures to these chemicals.

Proposition 65 also prohibits California businesses from knowingly discharging significant amounts of listed chemicals into sources of drinking water.

Proposition 65 requires California to publish a list of chemicals known to cause cancer, birth defects or other reproductive harm. This list, which must be updated at least once a year, has grown to include approximately 900 chemicals since it was first published in 1987.

- What types of chemicals are on the Proposition 65 list?

The list contains a wide range of naturally occurring and synthetic chemicals that include additives or ingredients in pesticides, common household products, food, drugs, dyes, or solvents. Listed chemicals may also be used in manufacturing and construction, or they may be byproducts of chemical processes, such as motor vehicle exhaust.

- What does a warning mean?

If a warning is placed on a product label or posted or distributed at a workplace, a business, or in rental housing, the business issuing the warning is aware or believes that it is exposing individuals to one or more listed chemicals.

By law, a warning must be given for listed chemicals unless the exposure is low enough to pose no significant risk of cancer or is significantly below levels observed to cause birth defects or other reproductive harm.

- Where can I get more information on Proposition 65?

If you have specific questions on the administration or implementation of Proposition 65, you can contact OEHHA's Proposition 65 program at P65.Questions@oehha.ca.gov, or by phone at (916) 445-6900.