

Manual Book

Ceiling Fan With Lights

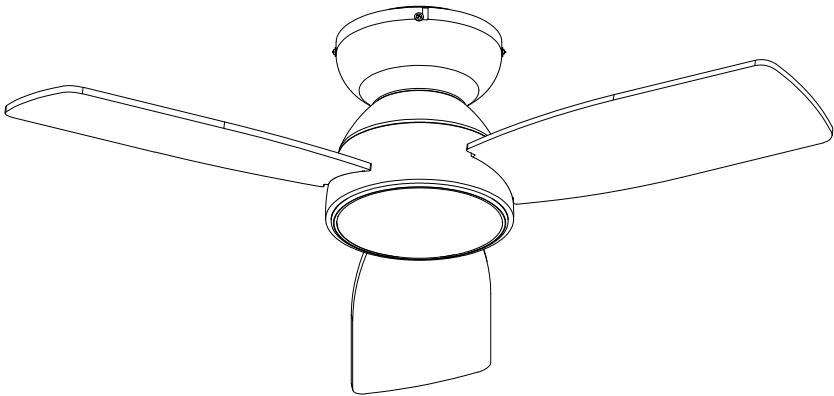

Safety Rules

1. Be sure the power to the wires you are working on is disconnected, either the fuse is removed or the circuit breaker is turned off. Turning the power off using the light switch is not sufficient to prevent electrical shock.
2. A qualified licensed electrician is required for the installation.
3. The outlet box and support structure must be securely mounted and capable of reliably /supporting a minimum of 70 pounds. Use only UL (cUL for Canadian Installation) listed mounting boxes marked "FOR FAN SUPPORT".
4. The fan must be mounted with a minimum of 7 feet clearance from the trailing edge of the blades to the floor.
5. Do not operate reversing switch while fan blades are in motion (if applicable). The fan must be turned off and the blades stopped before reversing the blade direction.
6. Do not place any objects in the path of the blades.
7. To avoid personal injury or damage to the fan and other items, be cautious when working around or cleaning the fan.
8. Do not use water or detergents when cleaning the fan or fan blades. A dry dust cloth or lightly dampened soft cloth will be suitable for the cleaning.
9. After marking electrical connections, spliced conductors should be turned upward and pushed carefully up into the outlet box. The wires should be spread apart with the grounded conductor on one side of the outlet box.
10. Electrical diagrams are reference only, different fan lights may have different light shades and bulbs.
11. Use only our replacement parts. This equipment has been tested and found to comply with the limits for a class B digital device, pursuant to part 15 of the FCC Rules. These limits are to provide reasonable protection against harmful interference in a residential installation. This equipment generates, uses, and radiate radio frequency energy and if not installed and used in accordance with the instructions may cause harmful interference to radio communications.

Warning:

To reduce the risk of personal injury, use only the two steel screws and washers provided with the outlet box for mounting to the outlet box. Most outlet boxes commonly used for the support of lighting fixtures are not acceptable for fan support and need to be replaced, consult a qualified electrician if in doubt.

To reduce the risk of fire, electric shock, or personal injury, mount the fan to the outlet box marked "acceptable for fan support".

To reduce the risk of personal injury, do not bend the blade brackets (also referred to as flanges) during assembly or after installation. Do not insert objects in the path of the blades.

Installation Preparation

Tools You Need



Ladder

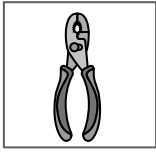

Pliers

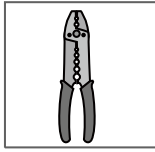

Wire Strippers

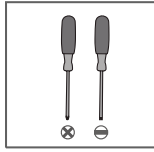

Screwdrivers

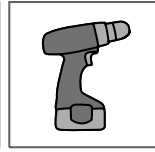

Power Drill (optional)



Drill Bit (optional)

If mounting to a support structure, you will also need the optional tools.

What to Expect with Your Installation

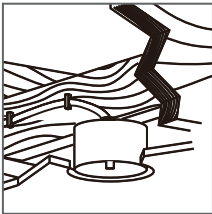

Must be able to secure the fan to building structure or fan-rated outlet box

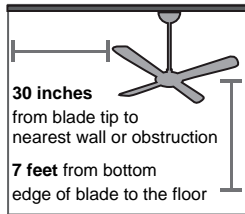

Assess location



Check the box to see the weight of the fan

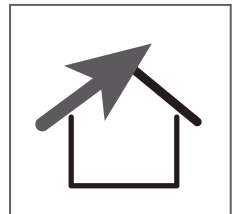



Not applicable for angled ceiling

Switch Selection

Note: Using a dimmer switch to control the fan may damage the fan. To reduce the risk of fire or electrical shock, do not use a dimmer switch to control the fan.

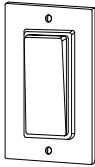
The recommended switches are as follows:

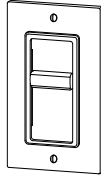
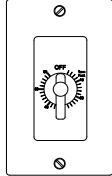
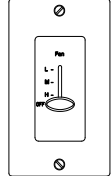
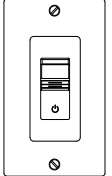
 Recommended:	 Single Pole Switch (Not Included)
 Not Recommended:	 Dimmer Switch  Timer Switch  Fan Speed Control Switch  Motion Sensor Switch

Installation Recommended

Room Size:

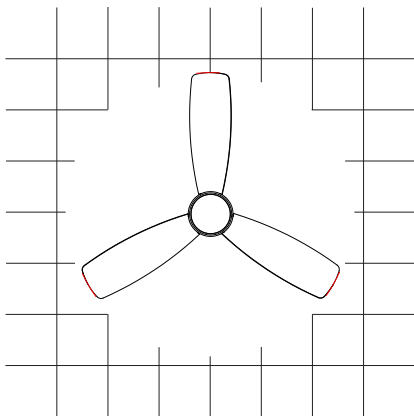

UP TO 10 ft × 12 ft

Room Height:

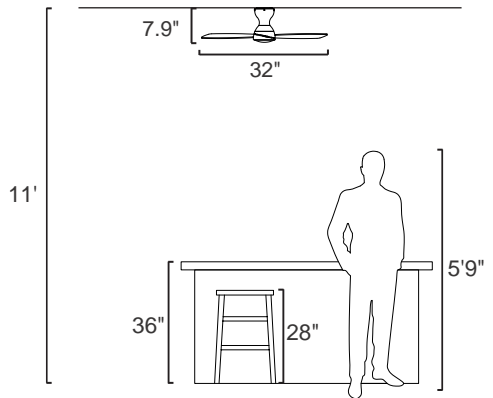





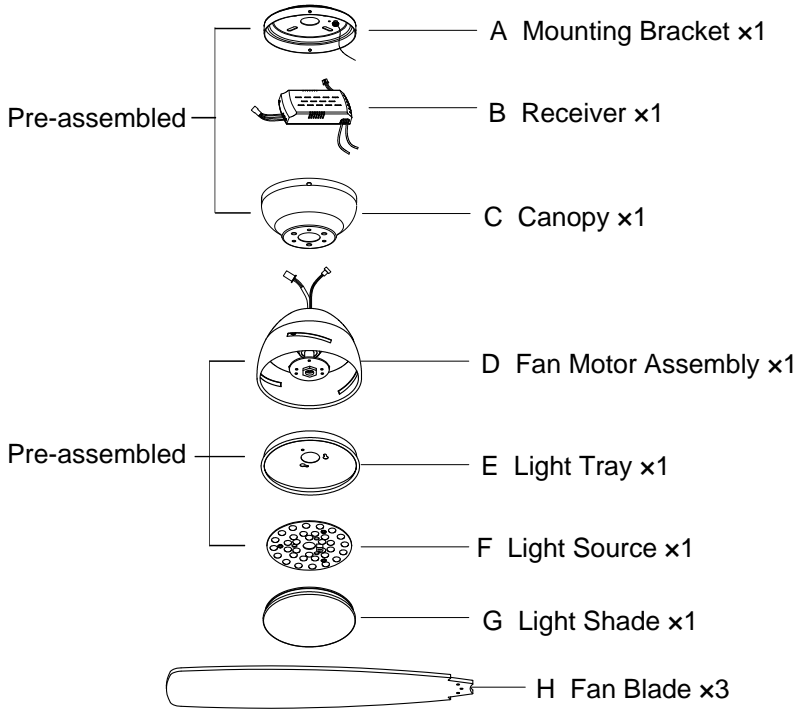





Recommended ceiling height: 8 to 12 ft.

Packing List



Installation Kit

AA	x3	BB	x2	CC	x4	DD	x4	EE	x4
									
Wire Nut		Outlet Box Screw		Wood Screw		Washer		Plastic Anchor	
FF	x1	GG	x1	HH	x2	II	x1	JJ	x1
									
Remote Control		Remote Holder		Remote Holder Anchor & Screw		"S" Hook		Gloves	

NOTE: The listed quantity is for installation, extra hardware may be included.

Installation Instructions

1. Assemble the Fan

Step 1. Loosen and remove the canopy screws from the round slots, and loosen the canopy screws in the 'L' slots but do not remove them, then take out the mounting bracket (A) from the canopy (C).

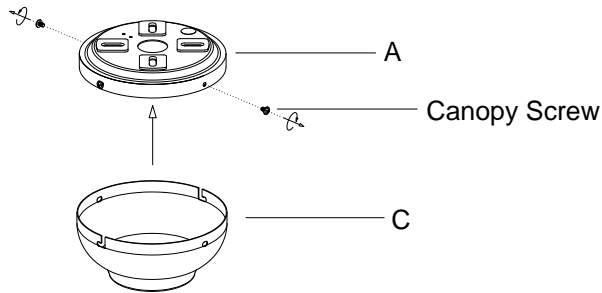

Step 2. Remove 3 set screws (larger-sized) from the fan motor assembly (D), thread the main wire through the canopy (C), and secure the canopy to the fan motor assembly (D) with set screws.

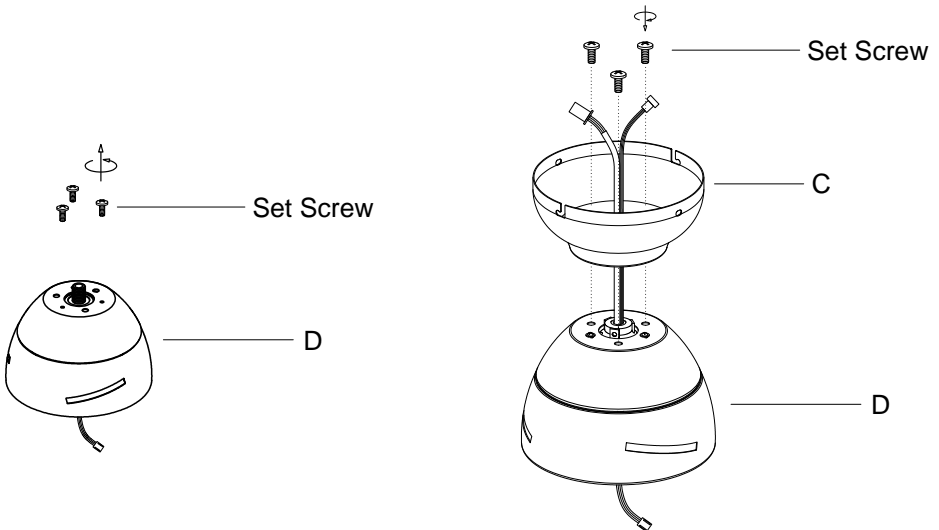

Step 3. Take off the light source (F) and loosen the light tray screw on the fan motor assembly (D), then take off the light tray (E).

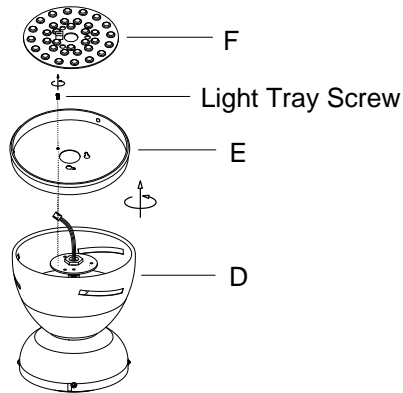

Step 4. Remove the fan blade screw and washer from the fan motor assembly (D), align the fan blades (H) with the holes on the fan motor assembly, secure them with washers and screws.

Note:

Make sure to assemble the blades in sequence and fasten the screws with equal force.

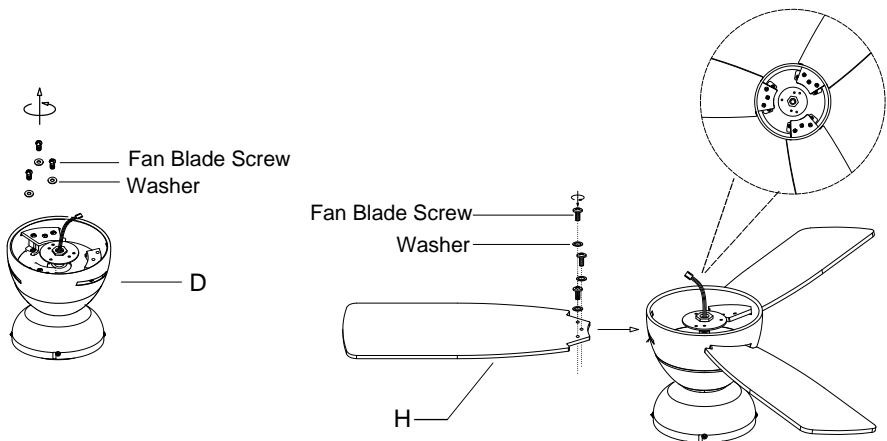

Step 5. Install the light tray (E) back to the fan motor assembly (D).
Step 6. Connect the light wire terminal to the interface on the light source (F).

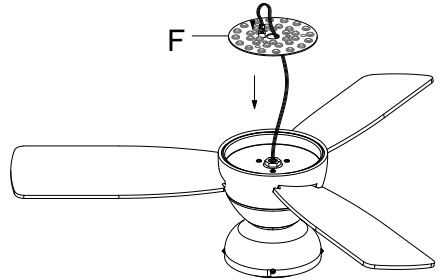
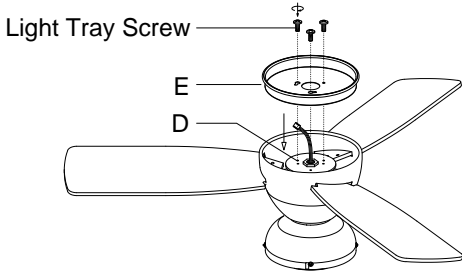

Step 7. Connect the fixture wires terminal to the interface on the receiver (B).

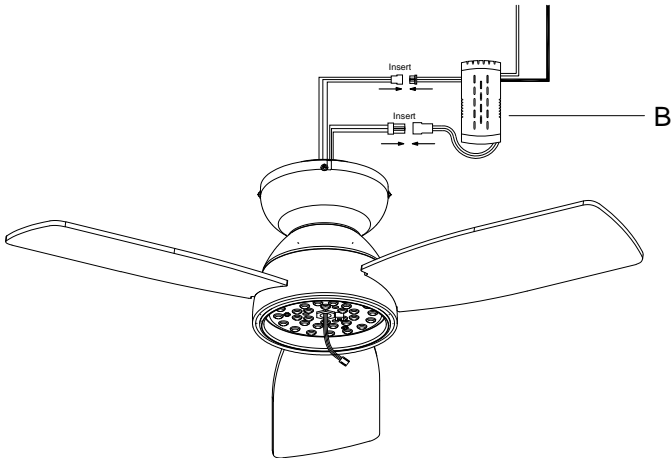

2. Mount the Bracket (3 Options)

Option1. (For Outlet Box)

Secure the mounting bracket (A) to the outlet box with screws taken off from outlet box or screws (BB) provided in the package.

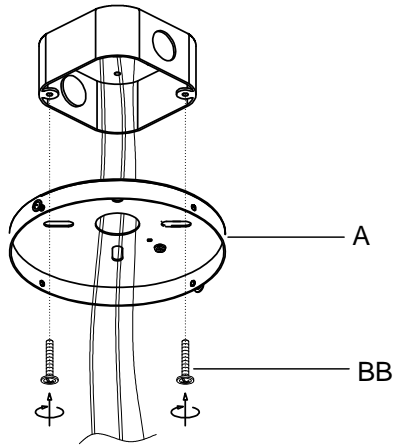

Option 2. (For Solid Wood Structure)

Mark and drill the screw holes on the solid wood structure. Mount the mounting bracket with wood screws (CC) and washers (DD).

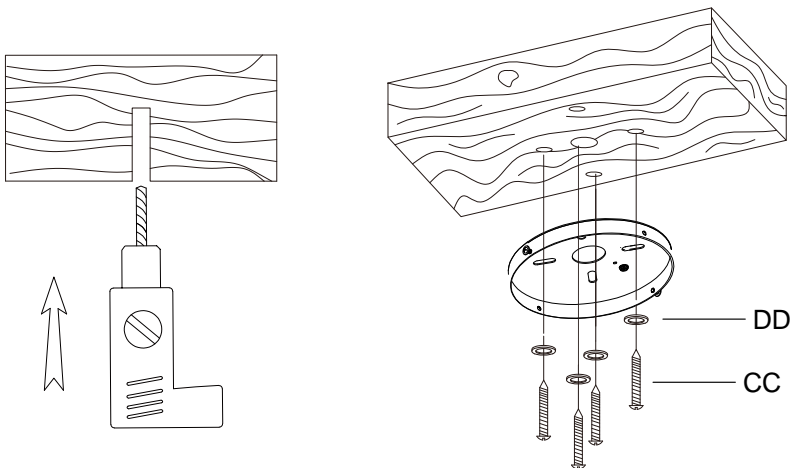

Option 3. (For Concrete Structure)

Mark and drill the anchor holes on the concrete structure, and then insert the plastic anchor (EE). Mount the mounting bracket to the concrete structure with wood screws (CC) and washers (DD).

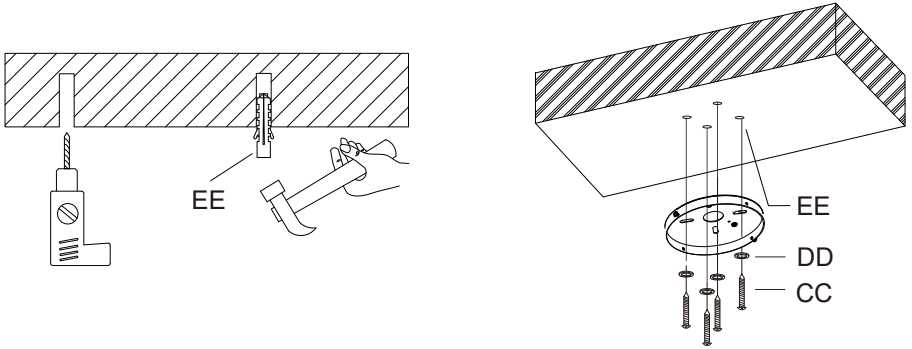

3. Hang the Fan

Hang the fan onto the mounting bracket with "S" hook (II) provided.

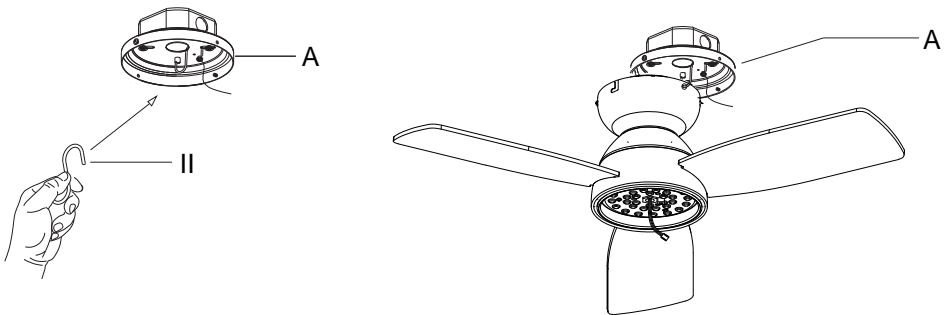

4. Connect the Wires

Step 1. Connect the wires from the receiver (B) to the house supply wires with wire nuts (AA), ground wire (green, green/yellow, or bare copper) to ground wire, neutral wire (white) to neutral wire, and hot wire (black) to hot wire.

Step 2. Wrap the connection with electrical tape.

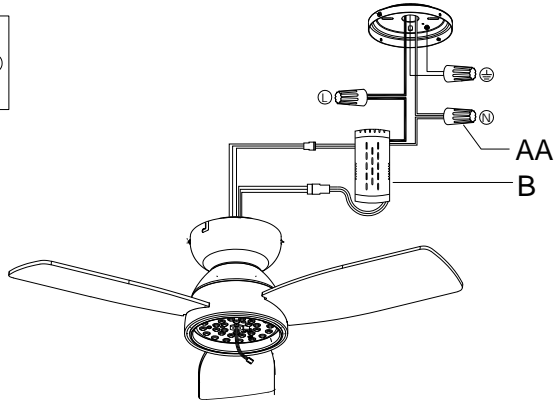
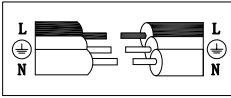

5. Attach the Canopy

Step 1. Take away the "S" hook (II).

Step 2. Align the "L" slots from the canopy to the canopy screws on the mounting bracket, rotate the canopy to lock it onto the mounting bracket.

Step 3. Tighten the canopy screws.

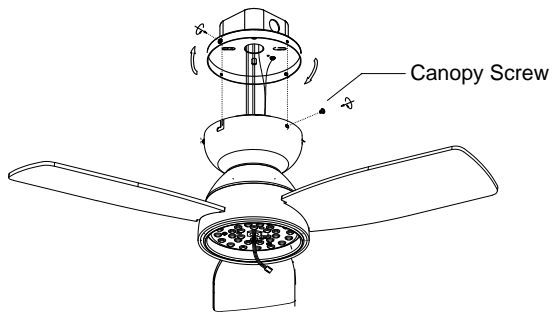
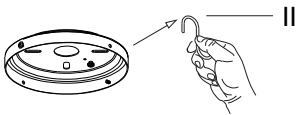

6. Install the Light Shade

Rotate the light shade (G) clockwise to secure it to the light tray (E).

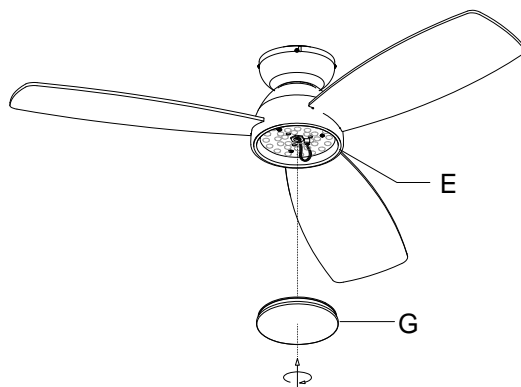

7. Install the Remote Holder

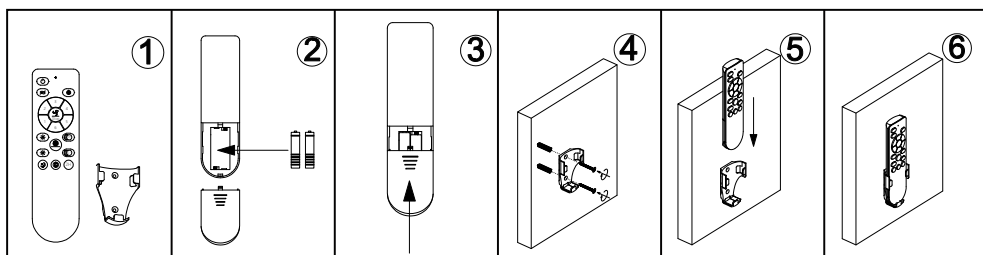

Step 1. Insert 2 batteries before using: AAA 1.5V battery x 2pcs (not included)

Step 2. Install the remote holder onto the wall with screws.

Remote Control Instructions

		Turn off fan and light.
		Turn on/off the light.
		Quick switch of the light color: Yellow Light → White Light → Natural Light
		Adjust the brightness of the light.
		Adjust the light color temperature.
		Night mode, lights will be dimmed when press this button.
		Fan speeds 1 through 6.
		Fan moves forwards or reversely.
		Natural Wind Mode: Fan speed automatically adjusts.
		Turn off the fan.
		Timing for 2 hours for the fan.

NOTE:

Please insert 2 batteries before using. AAA 1.5V battery x 2pcs (not included).

















REMOTE SIGNAL PAIRING:

If the Wall-Mounted Remote Control loses signal of the fan, press and hold the

button at the very beginning after it's turned on from Wall Remote Control. After the fan light flashes or beeps, it's done.

APP Control Instructions

Install the "FanLamp Pro" app from Google Play, Apple App Store or searching for the app name. Ensure that your phone is connected to the internet and Bluetooth enabled.

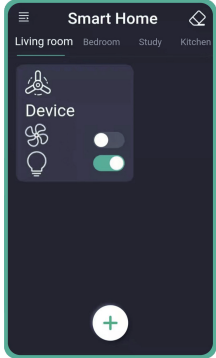
		<p>Pairing: Click the Pair button within 5 seconds after turning on the fan from the wall switch. Once the fan flashes or beeps, it has been successfully paired with your phone and can now be controlled through the app.</p>
		<p>Turn on/off the light.</p>
		<p>Quick switch for "White" light color.</p>
		<p>Quick switch for "Yellow" light color.</p>
		<p>Quick switch for "Natural" light color.</p>
		<p>Night mode: Dim the lights.</p>
		<p>Slide the slider to change the brightness of the light.</p>
		<p>Slide the slider to change the fan speed.</p>
		<p>Fan moves forward.</p>
		<p>Fan moves reversely.</p>
		<p>Change the direction of the wind. (Not supported)</p>
		<p>Timing the fan.</p>
		<p>Natural wind: The fan speed will change automatically when you use this function</p>
		<p>Sleeping wind. (Not supported)</p>
		<p>Turn on/off the fan.</p>
		<p>Unpairing: Click the unpair button within 5 seconds after turning on the fan. Once the fan flashes or beeps, it has been successfully unpaired from your phone.</p>
		

Trouble Shooting

1. Fan doesn't work

- Make sure the fixture is connected to an ON/OFF wall switch, not a dimmer switch.
- Check the remote control battery (not included in this package).
- Check the circuit breaker to ensure the power is on.
- Turn off power from the circuit breaker, then loosen the canopy and check all the connections according to the wiring diagram.

2. Lights Do Not Light Up / Flicker / Noisy Operation

- Make sure the fixture is connected to an ON/OFF wall switch, not a dimmer switch.
- Check your power and switch to make sure it's powered on.

3. Noisy Operation

- Tighten the light fitting and blade bottom cover.
- : Re-tighten all screws on the bracket, downrod, and fan blades (do not over tighten)
 - Check to see if any of the blades are cracked. If so, replace all of the blades.

4. Remote does not work

- Make sure the battery is installed correctly.
- Pair the remote control again. (See "Remote Control Instructions")
- Install 2 new batteries.

Clean And Care

To clean, wipe the fixture with a soft cloth. Spraying from chemical cleaners can discolor the finish of the fixture. Do not use scouring pads, powders, steel wool, or abrasive paper to clean this fixture.

Ordering Parts

Keep this manual for future reference, and in case replacement parts are needed. Available parts can be ordered from the place of purchase. Use exact wording from diagrams when ordering parts.