

# Assembly Instructions

## Stove Screen

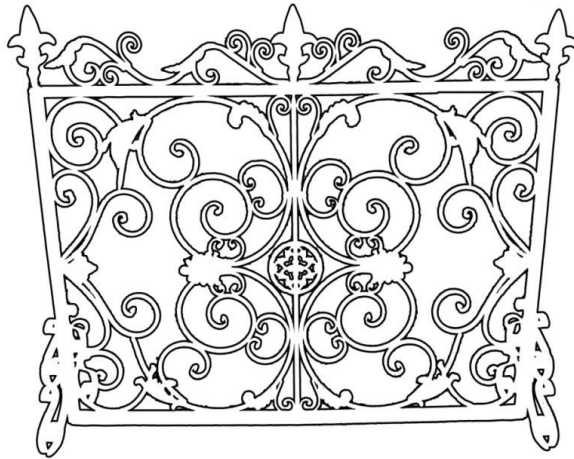

**Caution: You must read this before you proceed**



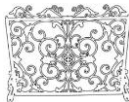

**CAUTION :** This tool is NOT a TOY.  
Keep your child / children at bay in the process of assembly.

### Parts List

N758LQQFS0805-BK+GD

| Label | Picture   | Description | QTY |
|-------|---|-------------|-----|
| A     |  | Screen      | 1   |
| B     |  | FOOT        | 2   |
| C     |  | Decoration  | 3   |

### Hardware

| Label | Picture   | Description  | QTY |
|-------|---|--------------|-----|
| D     |  | Allen wrench | 1   |
| E     |  | Nut          | 5   |

N758LQQFS0805

# Assembly Preparation

Before Beginning Assembly:

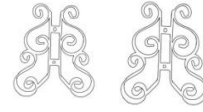
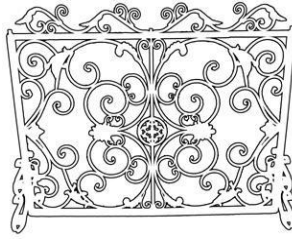
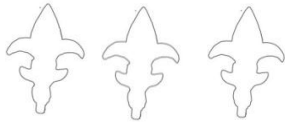
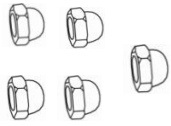

- Read instructions, cover to cover-



- Have 2 adults on hand for assembly-



- Do not assemble on flooring or carpet-



- Assemble on a clean non-marring surface (packing foam)-



- Save all packaging until finished-

## Assembly Steps

### Step 1

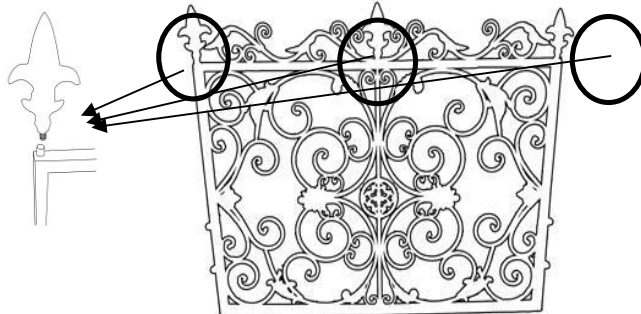

As the photo , screw C to the place.

### Step2

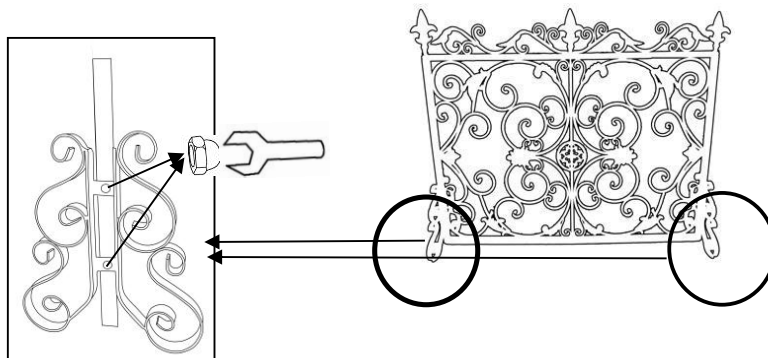





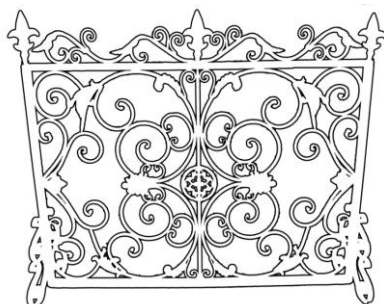















As the photo,fix B and tight on the product to the screen and it comes into use.

### Step3



As the photo,To straighten the product and it comes into use.

## Care & Maintenance

-   ● Do not put hot items directly on furniture surface
  -   ● Do not clean furniture with harsh cleansers or polish.
  -   ● Do not place furniture under direct sunlight.
  -   ● Do not place furniture near heating or cooling vents.
  -   ● Do not write on furniture without a padded barrier to protect the surface.
  -   ● Do not place furniture outside . For indoor use only .
  -   ● Not for commercial use. For residential use only .
  -   ● Stains may be removed with mild soap solution and damp cloth.
  -   ● Children should not climb or jump on the furniture.
- 
-   ● Dust and pick-up spills using a clean, non-colored, lint-free cloth .

### What is Proposition 65?

Proposition 65 is a California law that requires warning labels on products that may contain one of more than 800-plus chemicals or ingredients that the California Office of Environmental Health Hazard Assessment (OEHHA) has deemed to cause cancer or other reproductive toxicity. Chemicals and elements on this list include wood dust, brass, and other everyday substances, which can be found in very common household items, such as: lamps, tableware, jewelry, crystal glasses, electric cords, beauty products, automobiles, and furniture.

### Why Did I Find a Proposition 65 Warning on My Home Goods Product?

We include Proposition 65 warnings on all of our products because there is always a chance that one of the 800-plus common chemicals and ingredients listed under this law could potentially be on our furniture or packing materials. We risk large fines under this law, if we don't include this warning.

### Should I worry?

We realize you may be worried finding this warning on our products, but we want to reassure you that the hazardous exposure limits for any of these chemicals have never been found on furniture products that we've shipped to our customers. Additionally, this warning label is very common and can be found on almost every piece of furniture sold in the state of California.

### Just How Common Are Proposition 65 Warnings?

Proposition 65 warnings have become so common in California that it is hard to take a trip to a local bank, grocery store, or restaurant without finding at least one warning. In fact, even the Disney Land Resort has a Proposition 65 warning:

