

Assembly Instruction

Decorate your home, Brighten wonderful life

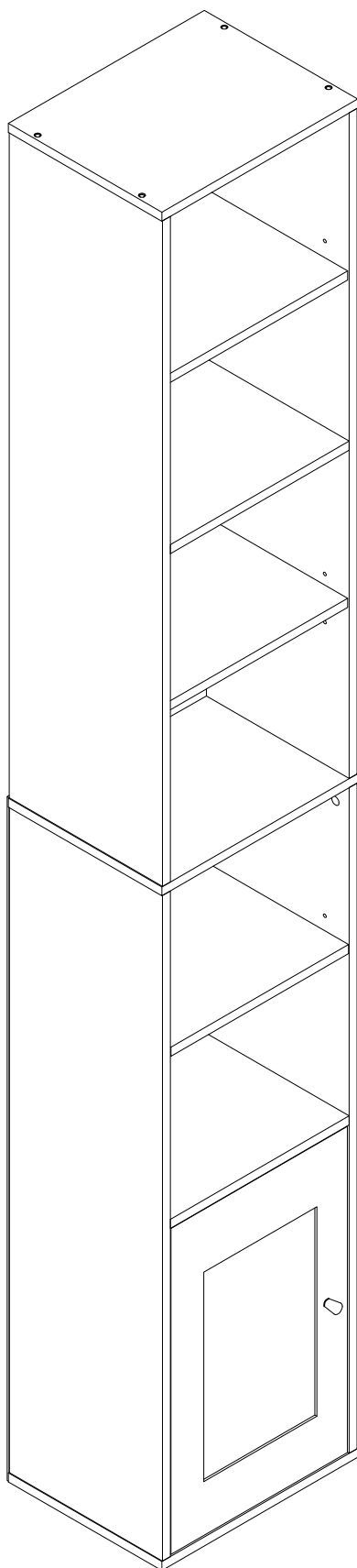
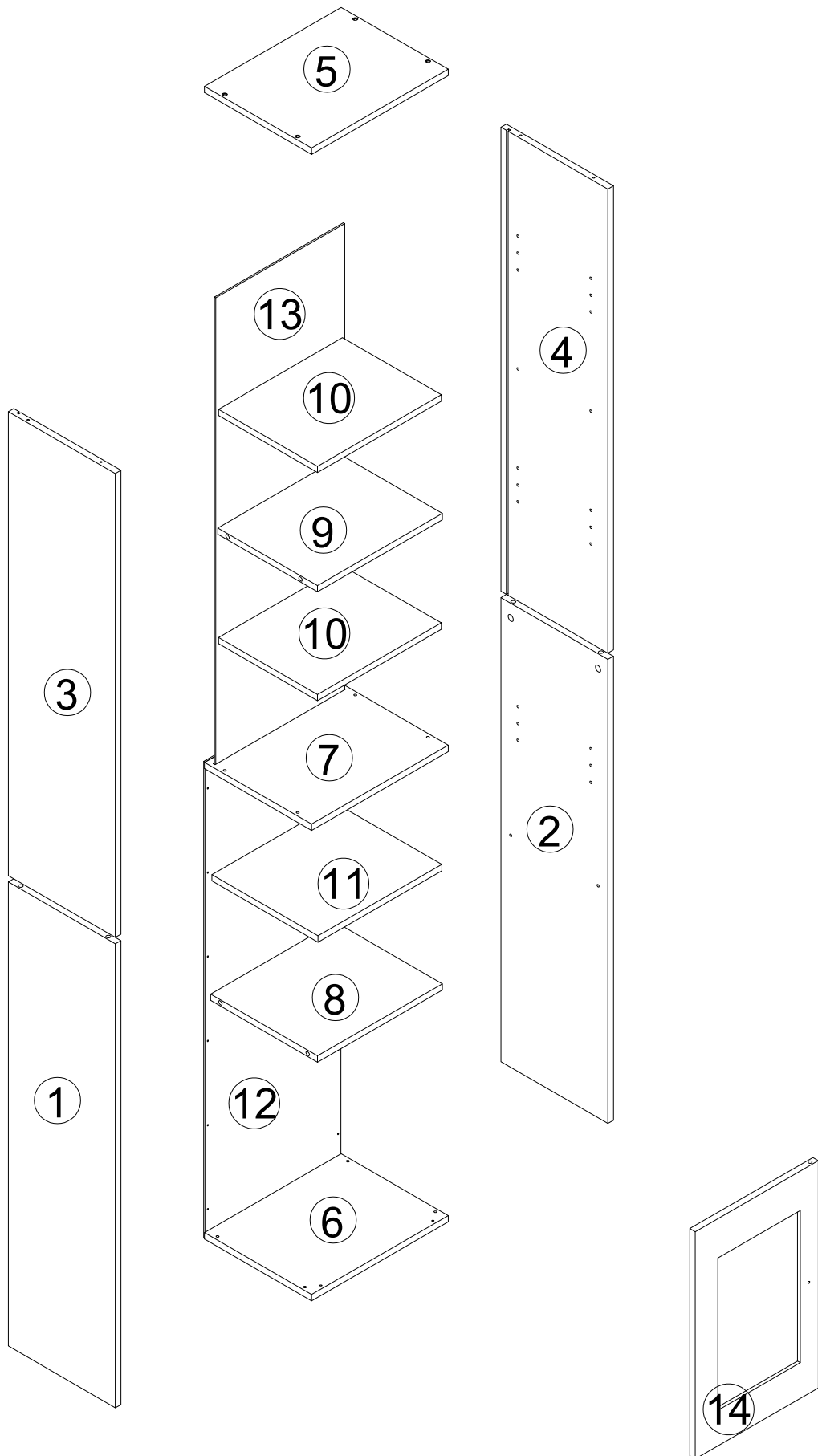
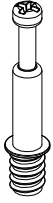

PLATE NUMBER



ACCESSORIES LIST

A ×8



M6×35

B ×12

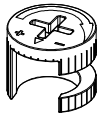

12×10

C ×8

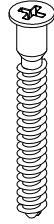

M5×40

D ×2

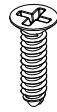

M3×12

E ×10

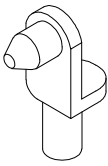

F ×2

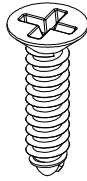

M3×14

G ×1

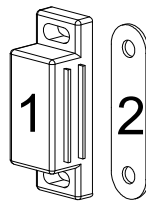

H ×24

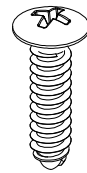

J ×2

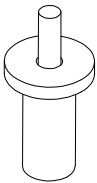

K ×1



L ×1

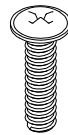

M4×16

M ×2

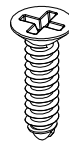

M3.5×12

N ×2

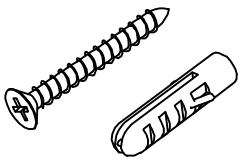

P ×2

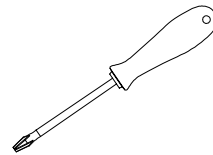
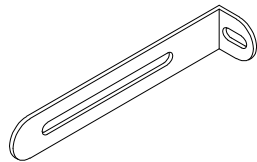

STEP1

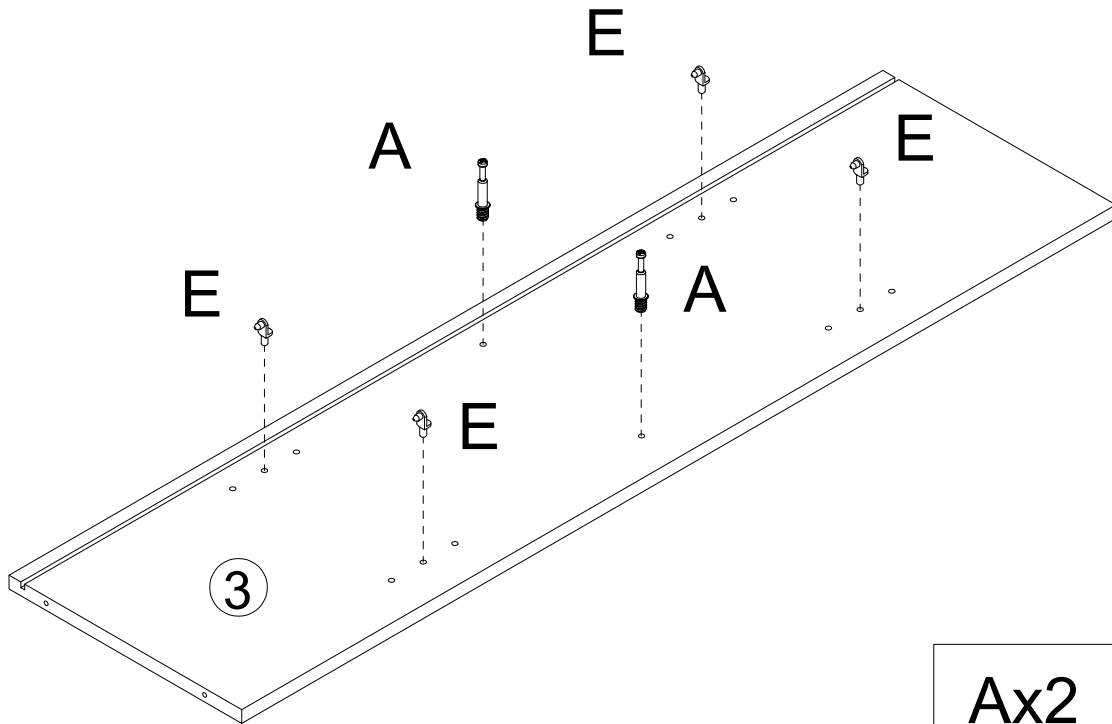
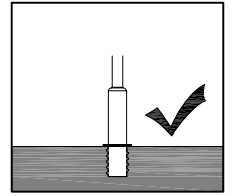
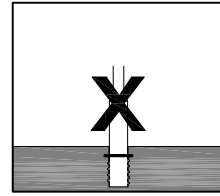
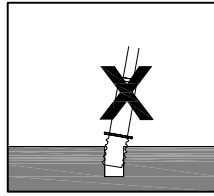
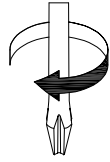

Ax2

Ex4

STEP2

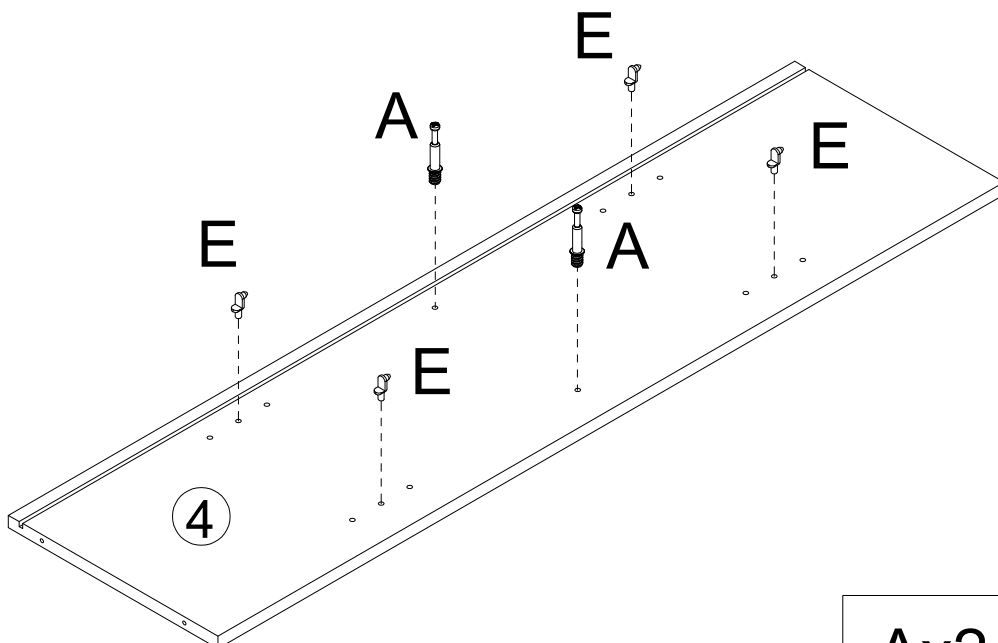
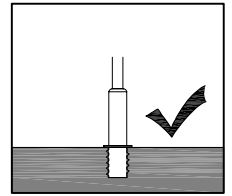
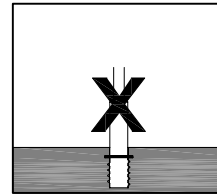
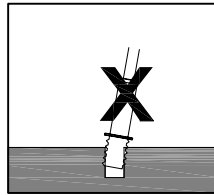
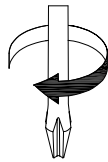

Ax2

Ex4

STEP3

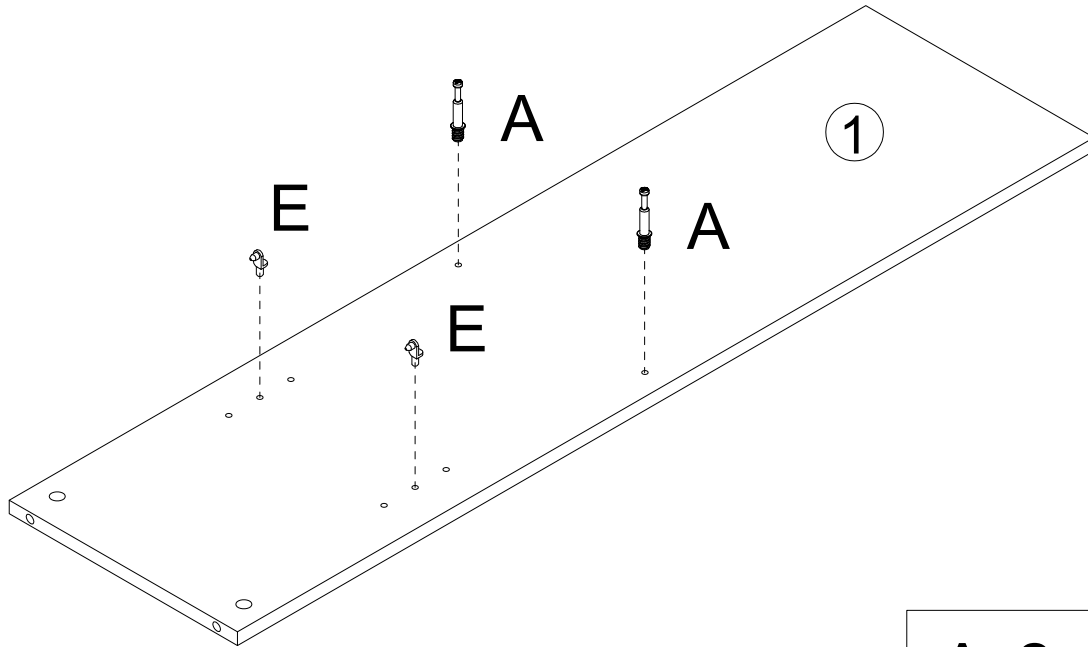
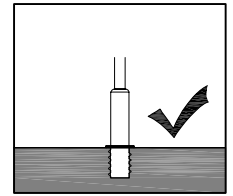
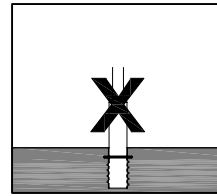
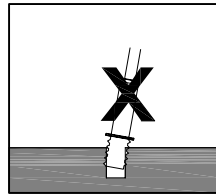
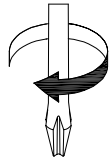

Ax2

Ex2

STEP4

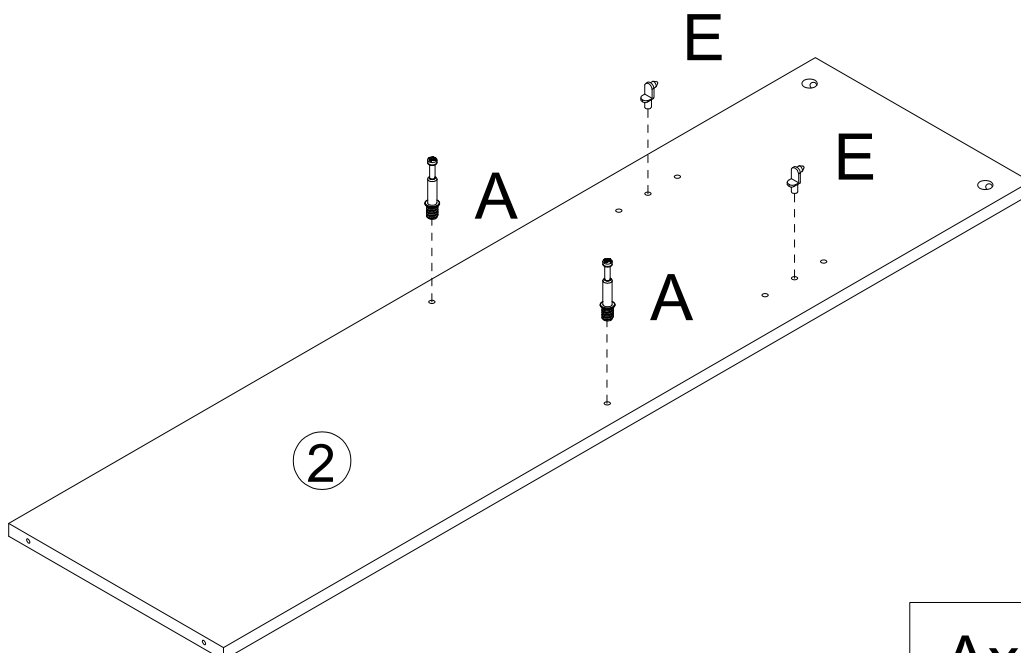
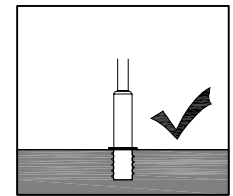
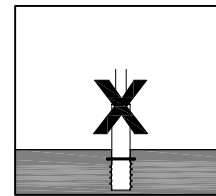
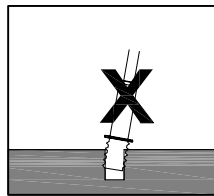
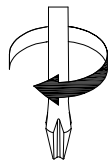

Ax2

Ex2

STEP5

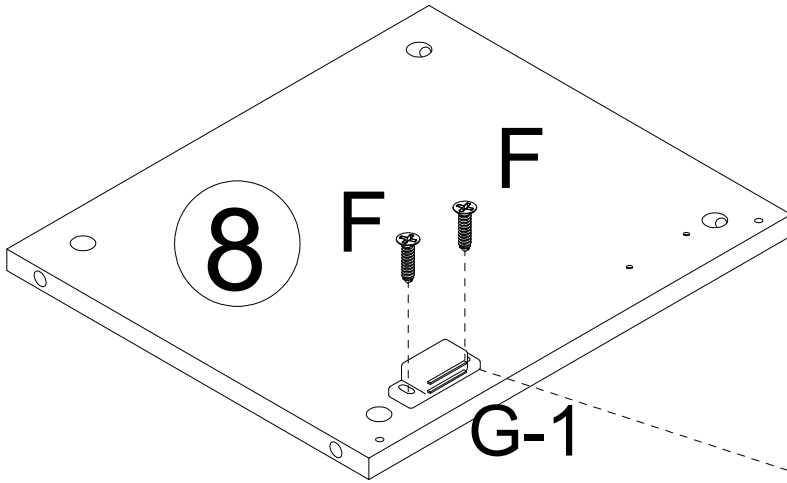
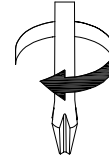

When the door is opened on the left, the installation method of the No. 8 plate and the door suction seat G-1

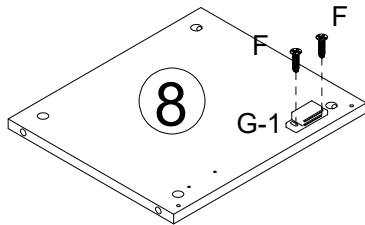

When the cabinet door is opened on the right, the installation method of the No. 8 plate and the door suction seat G-1

Fx2

G-1x1

STEP6

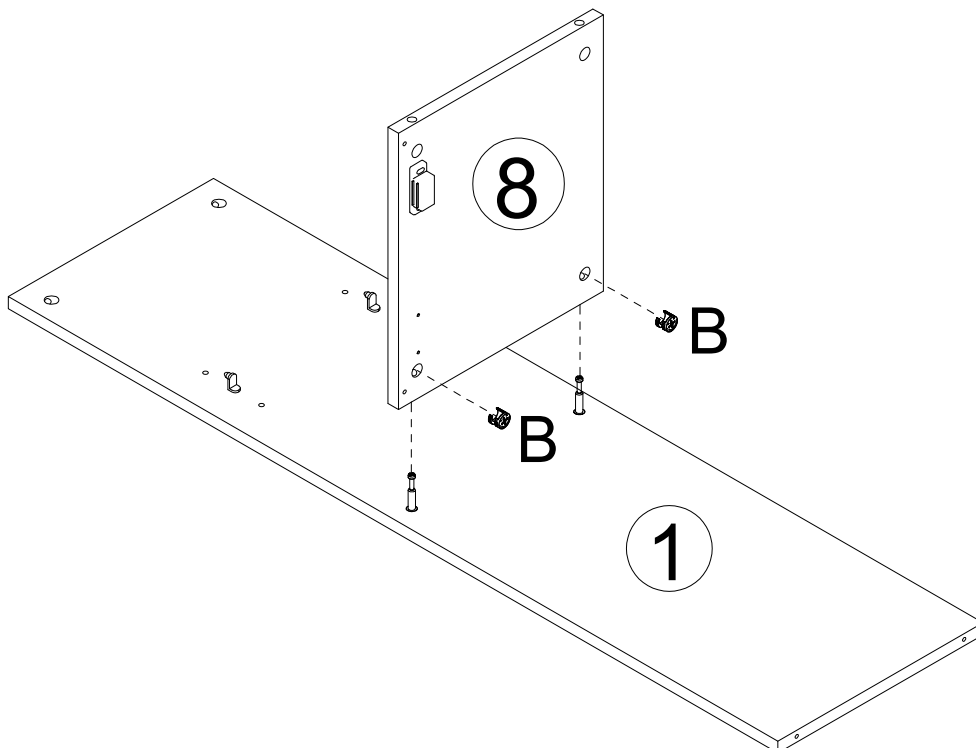
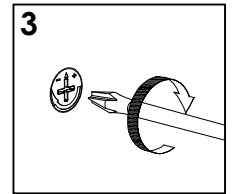
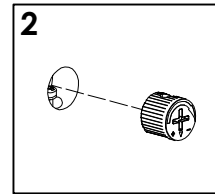
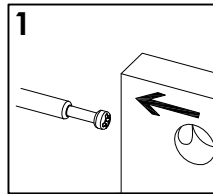
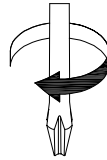

Bx2

STEP 7

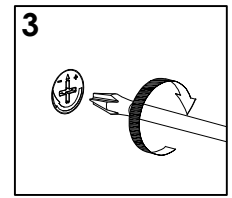
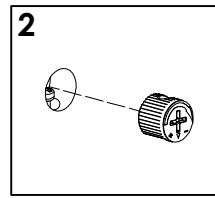
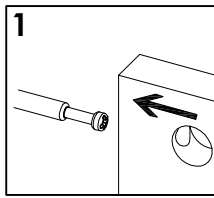
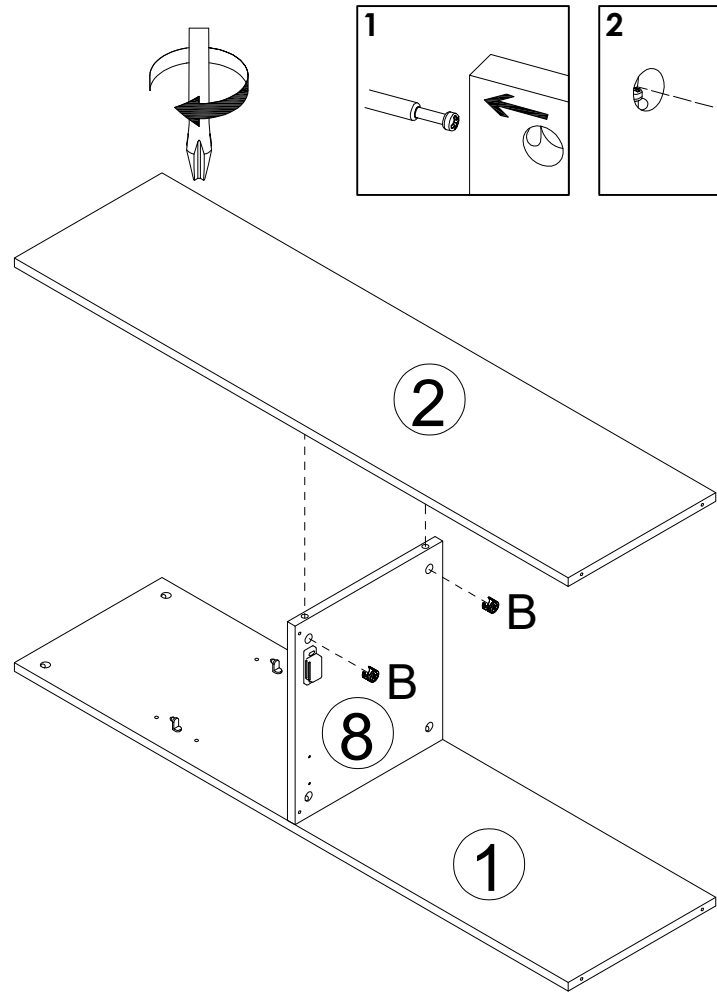

Bx2

STEP 8

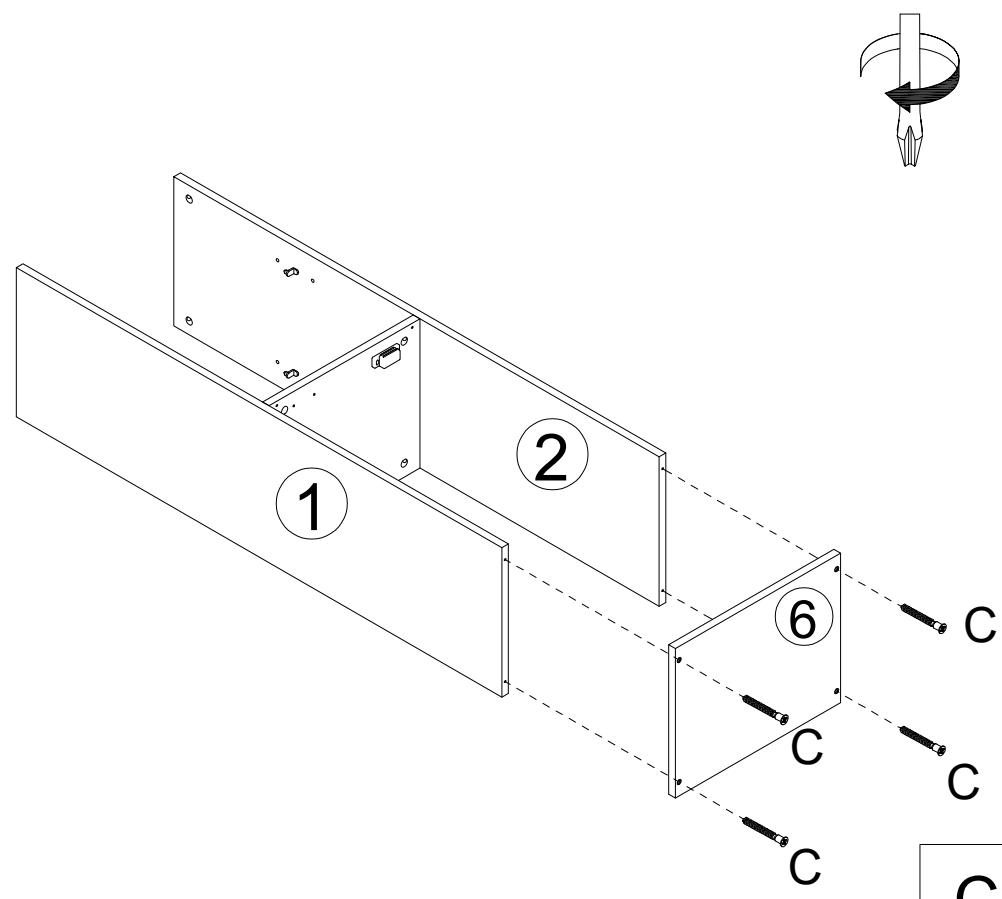

Cx4

STEP9

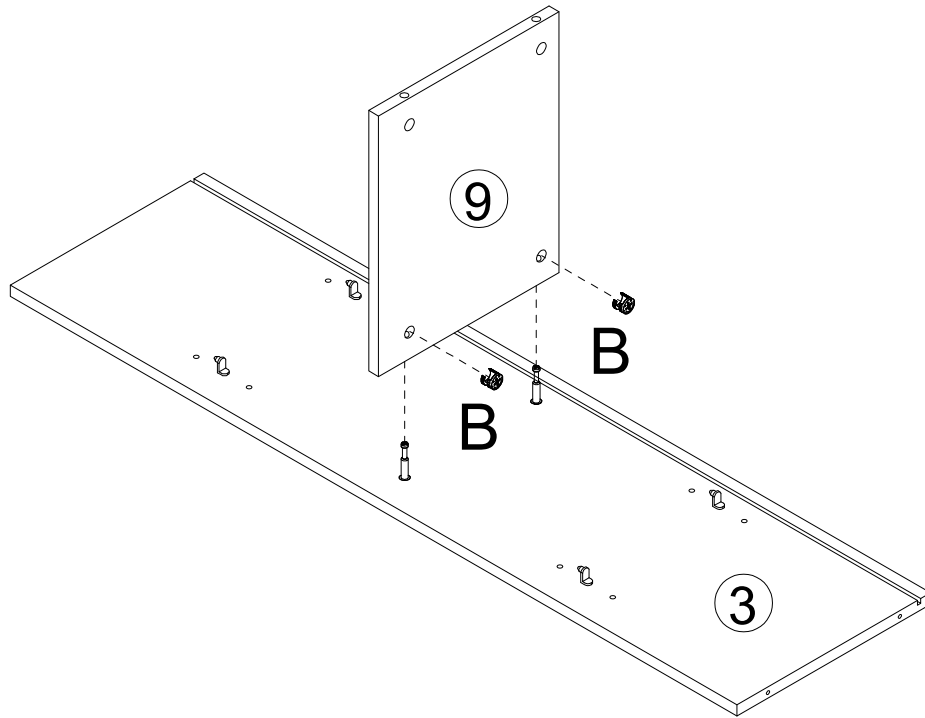
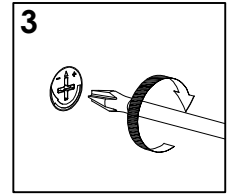
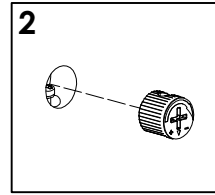
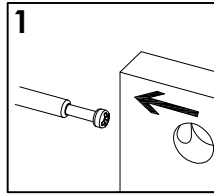
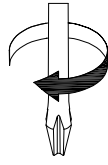

Bx2

STEP10

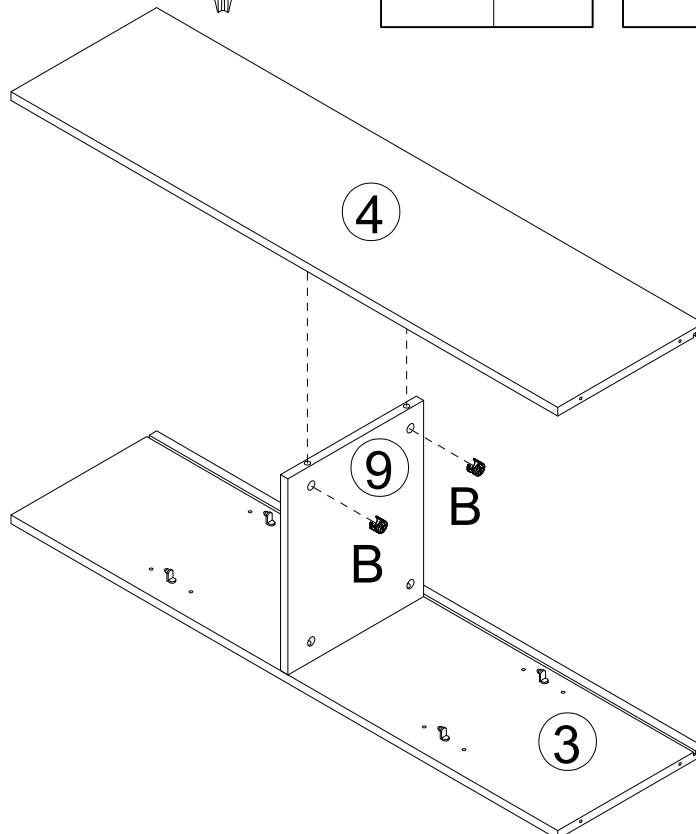
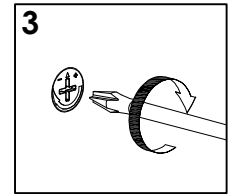
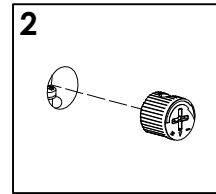
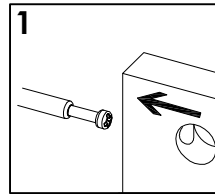
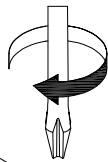

Bx2

STEP11

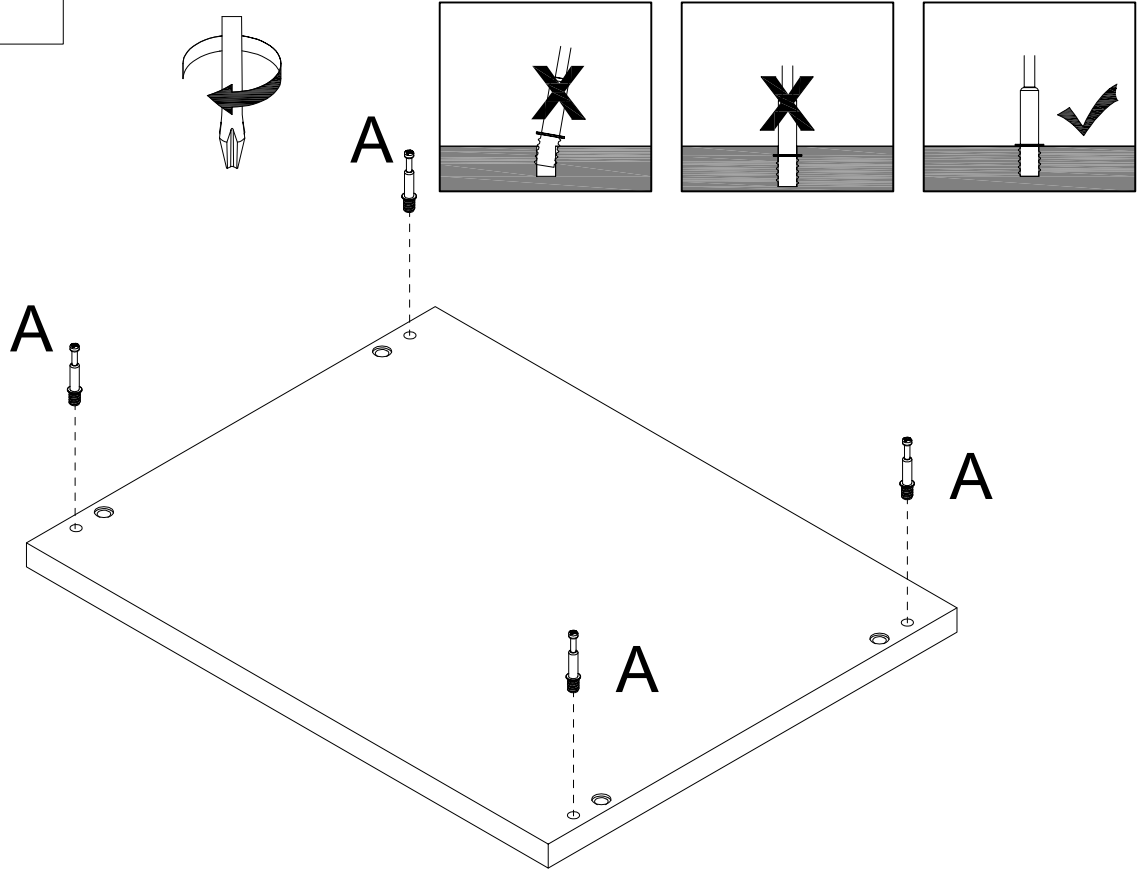

Cx4

STEP12

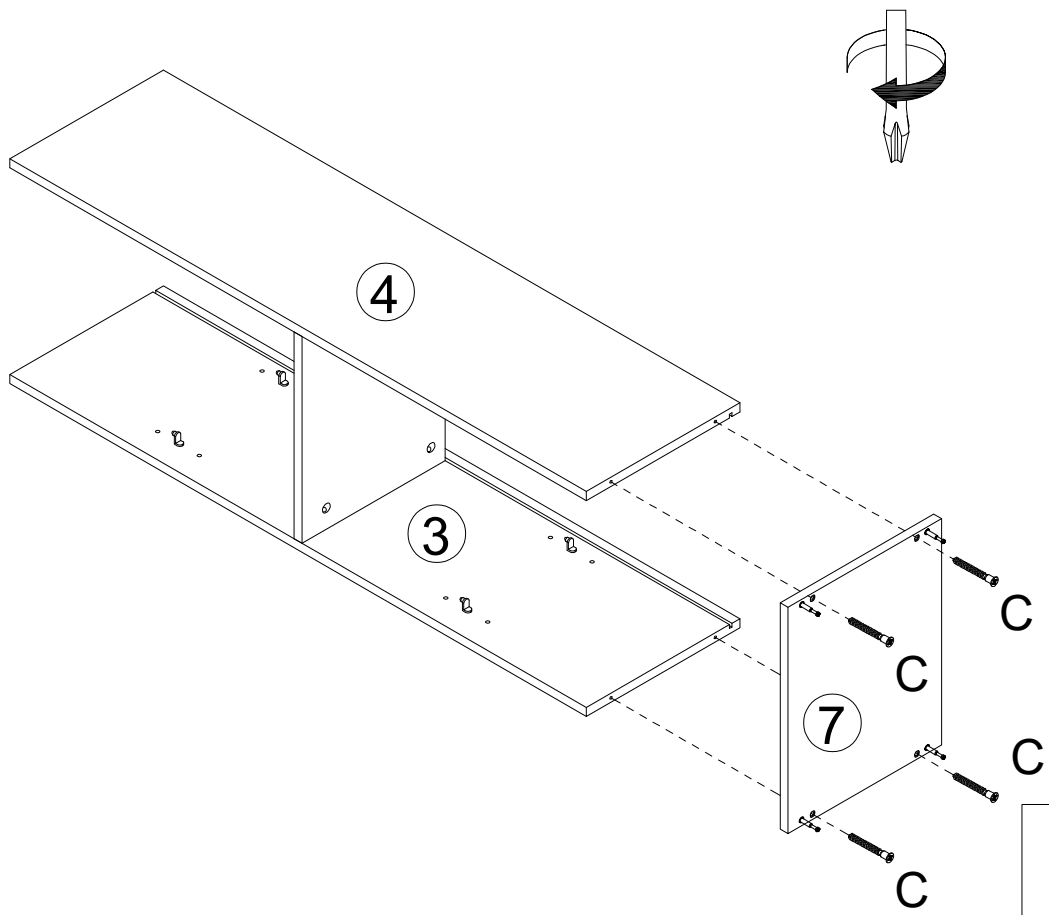

Cx4

STEP13

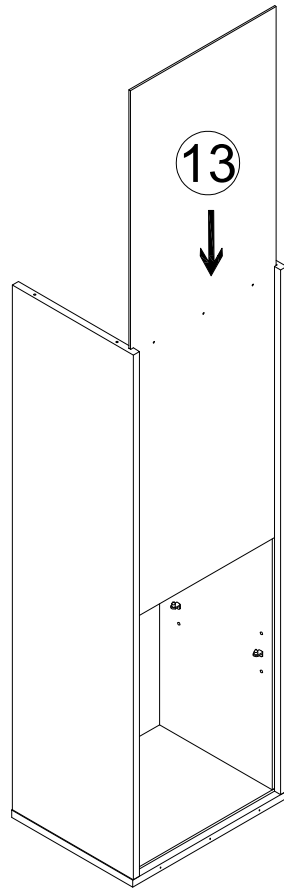

STEP14

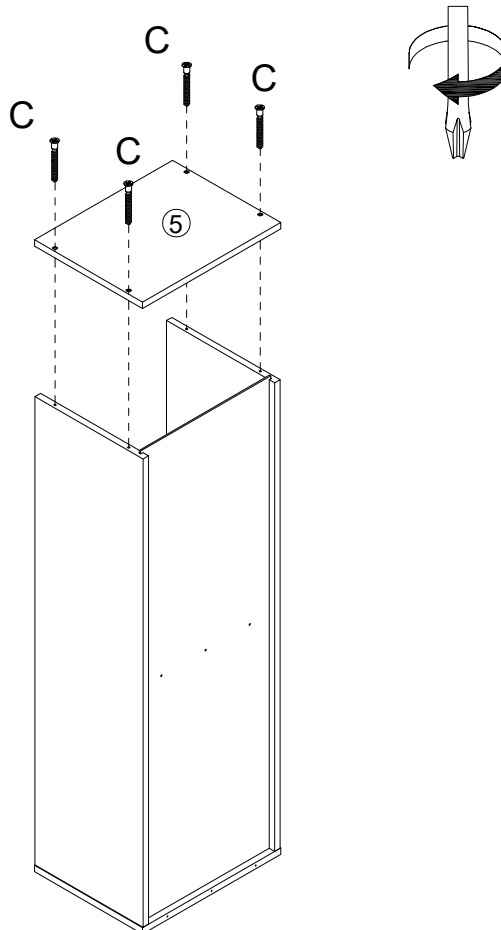

Cx4

STEP 15

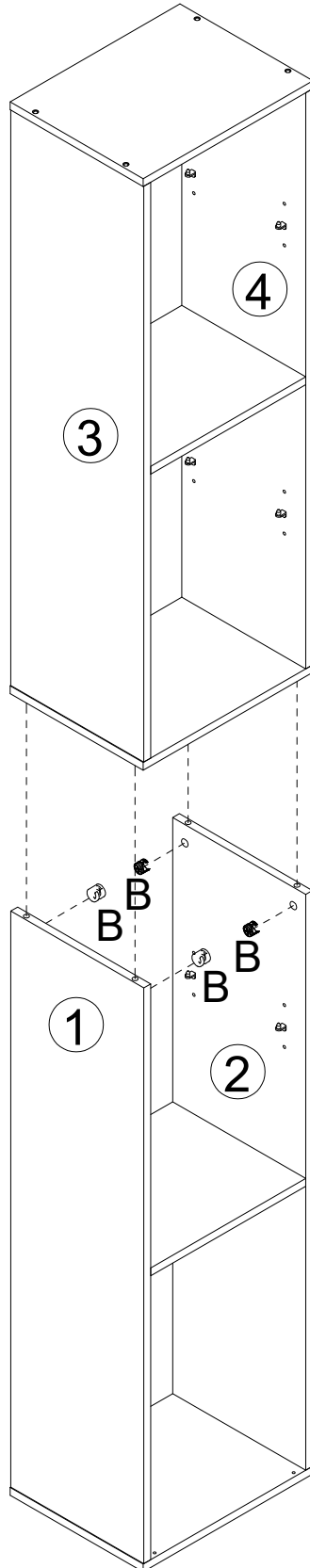
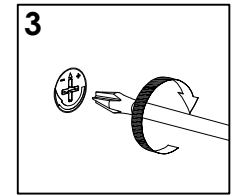
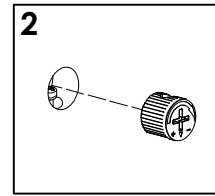
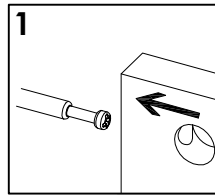
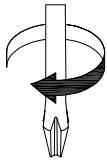

Bx4

STEP 16

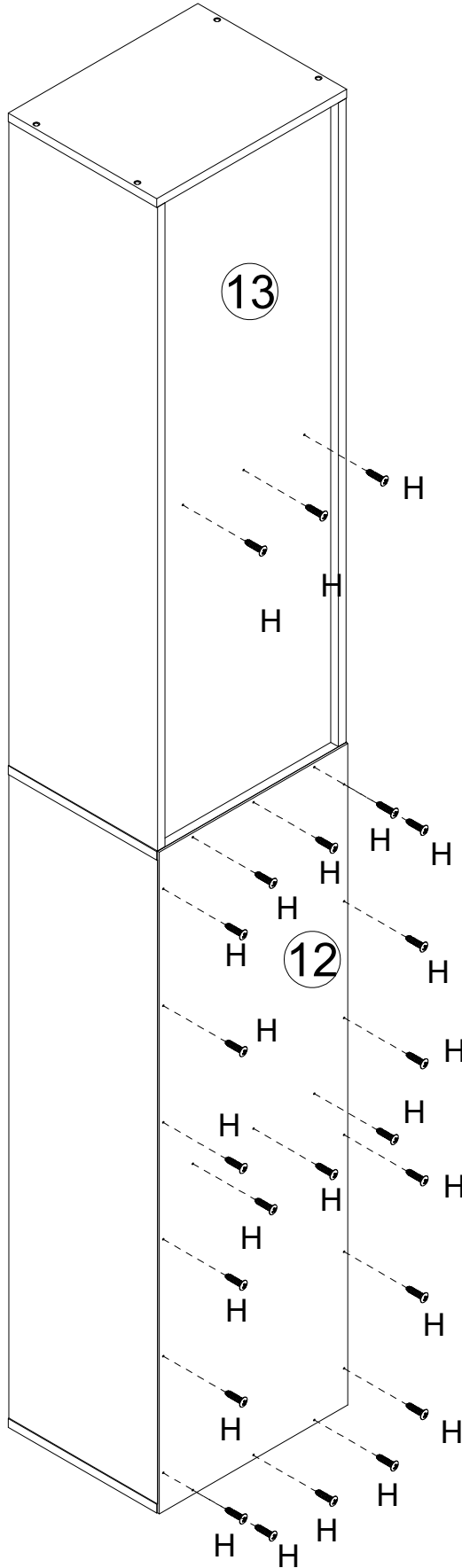
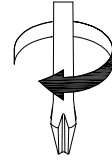

Hx24

STEP17

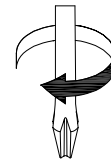

When the cabinet door is opened on the left, the No. 14 plate and the door suction plate G-2 are installed

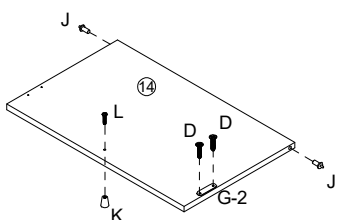
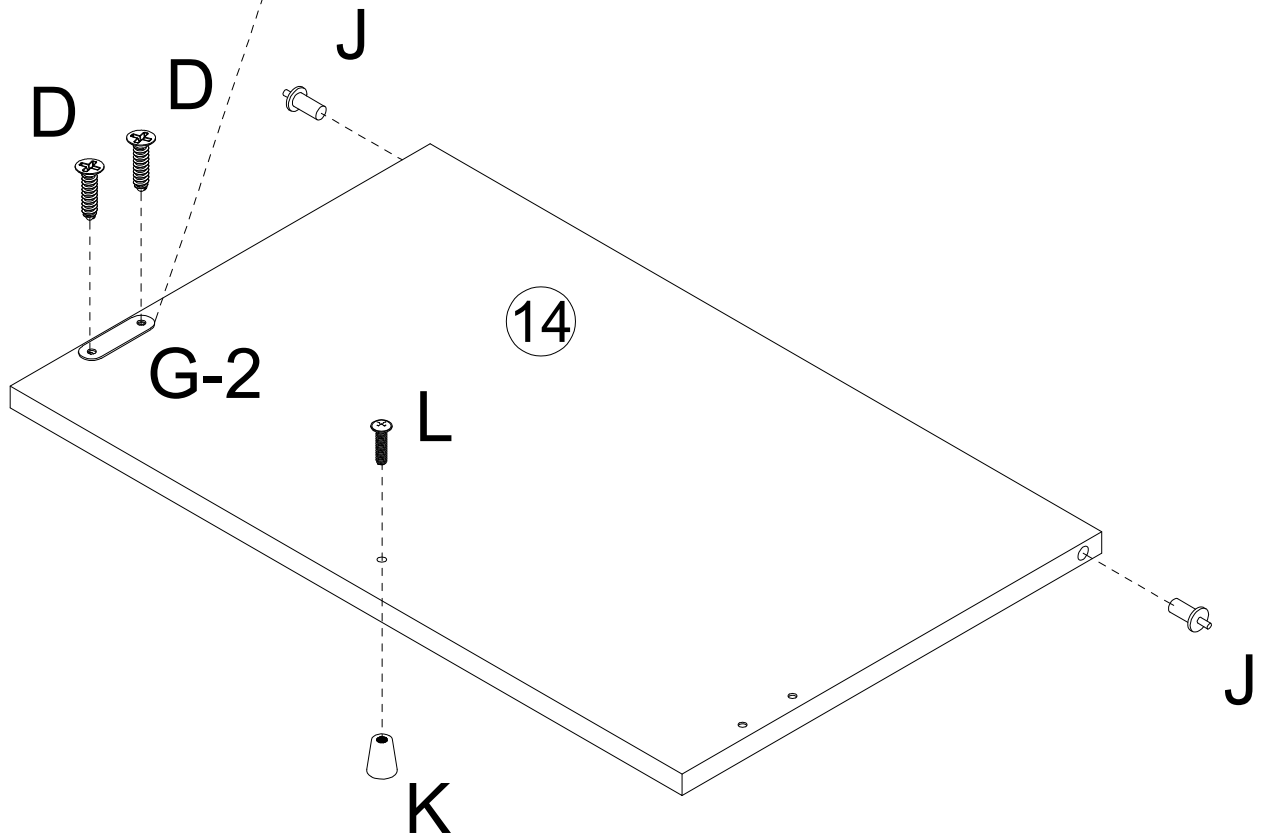

When the cabinet door is opened on the right, the installation method of the No. 14 plate and the door suction plate G-2

	Dx2	G-2x1
Jx2	Kx1	Lx1

STEP 18

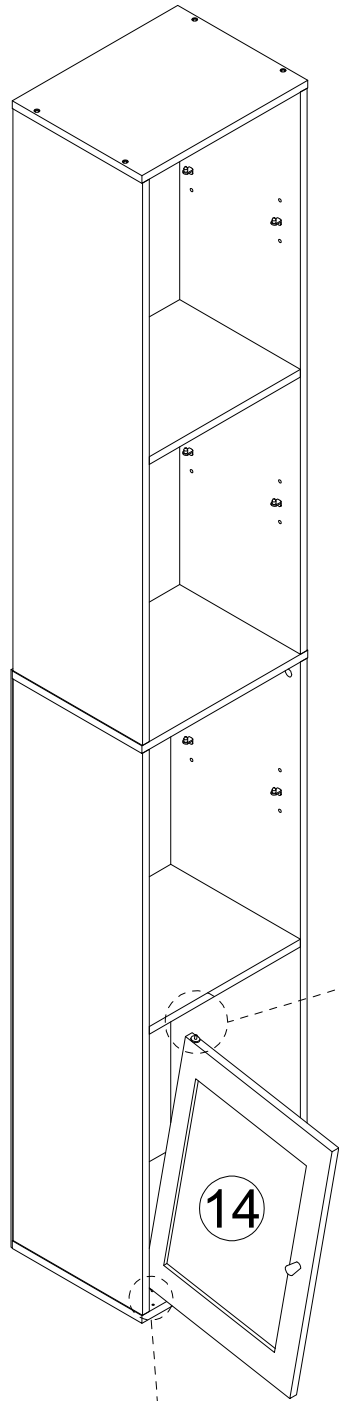

with your hand

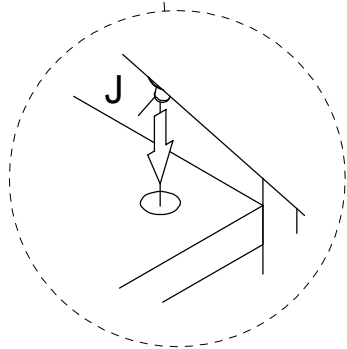
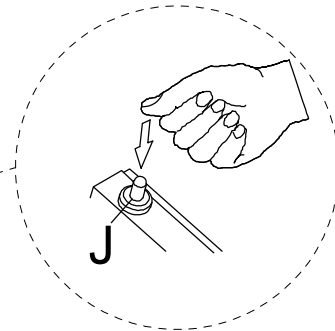

Cabinet door right opening installation method

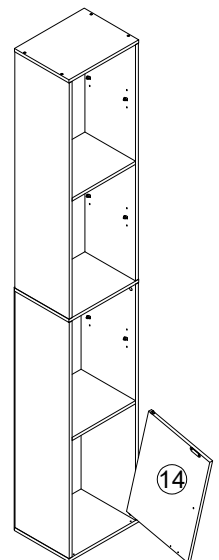

STEP 19

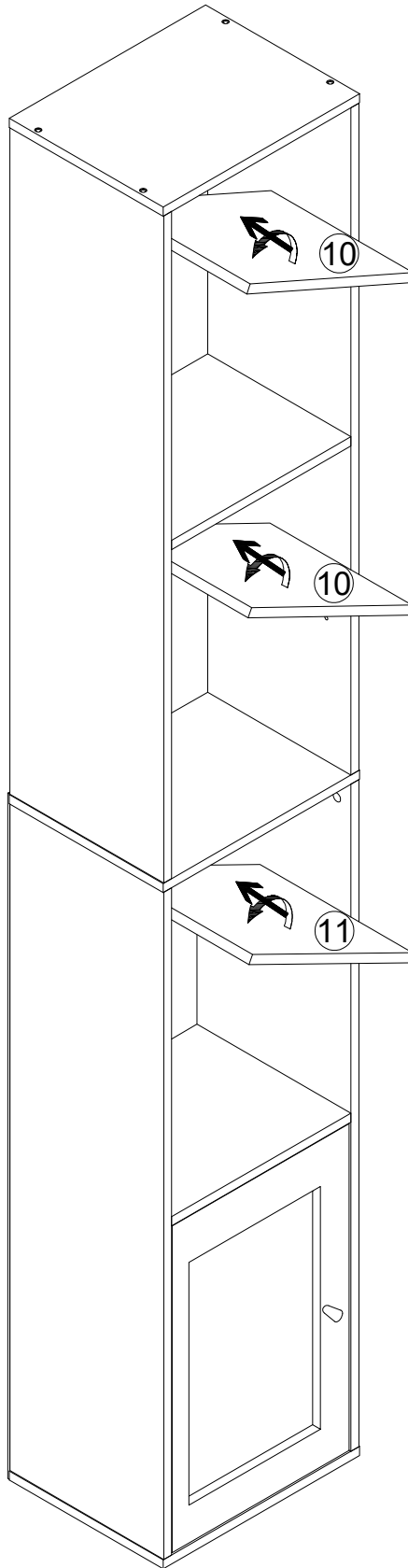

STEP20

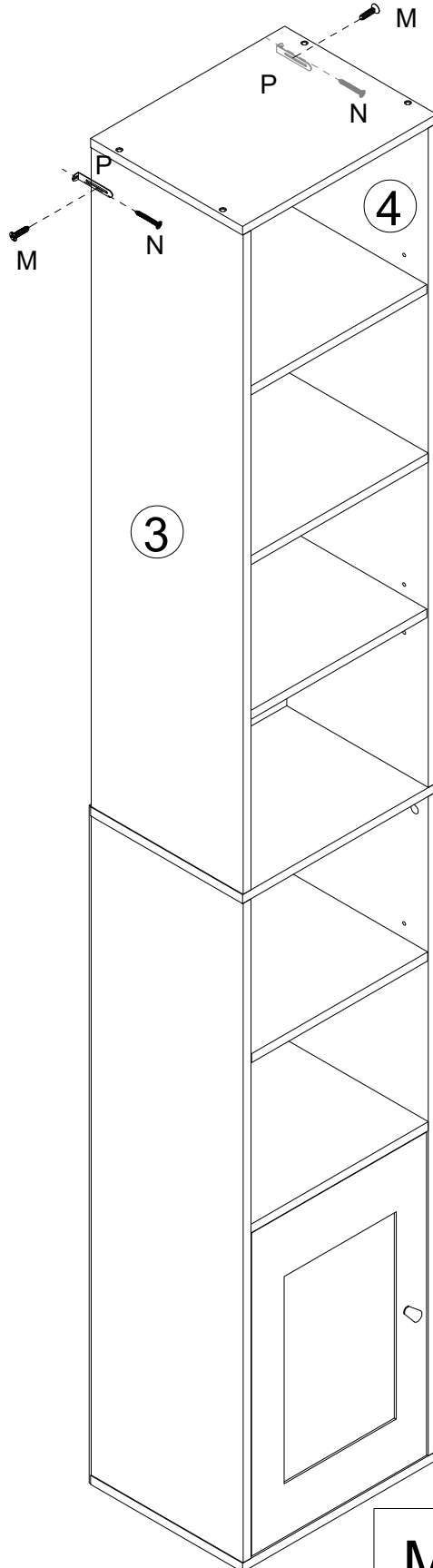
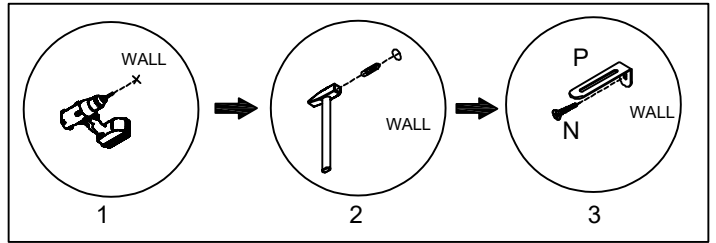
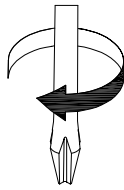

Mx2	Nx2	Nx2
-----	-----	-----