

ASSEMBLY INSTRUCTION











Read instructions carefully prior to assembly.

Thank you for purchasing this quality product. Check carefully for small parts which may have come loose during shipment.

Remove all components from pack and place table top upside down on soft surface such as carpet or cloth to prevent scratching the finish. Identify and count all parts as specified below.

Do not tighten bolts until assembly is complete.

HARDWARE LIST

NO.	PART	DESCRIPTION	Q'TY
A		glass top	1
B		legs	2
C		base	1
D		caps	4
E		long screw	4
F		short allen key	1
G		metal plate	2
H		small rod	4
I		long allen key	1
J		short screw	2

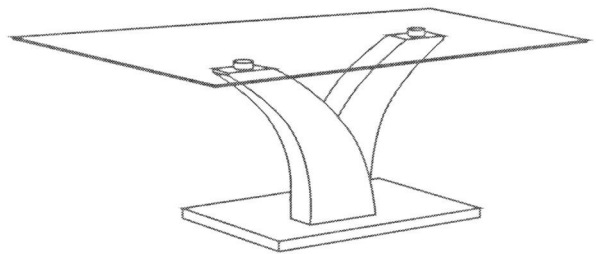

step 1

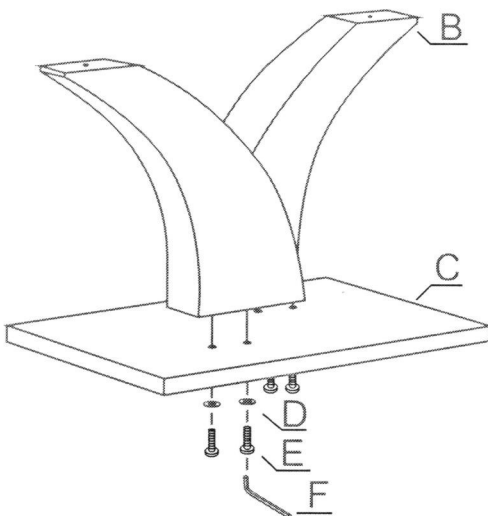

step 2

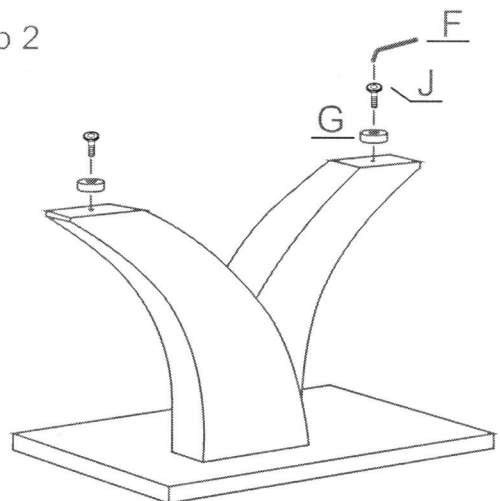

ASSEMBLY INSTRUCTION











Read instructions carefully prior to assembly.

Thank you for purchasing this quality product. Check carefully for small parts which may have come loose during shipment.

Remove all components from pack and place table top upside down on soft surface such as carpet or cloth to prevent scratching the finish. Identify and count all parts as specified below.

Do not tighten bolts until assembly is complete.

HARDWARE LIST

NO.	PART	DESCRIPTION	Q'TY
A		glass top	1
B		legs	2
C		base	1
D		caps	4
E		long screw	4
F		short allen key	1
G		metal plate	2
H		small rod	4
I		long allen key	1
J		short screw	2

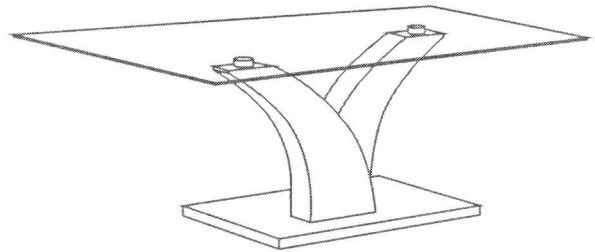

step 1

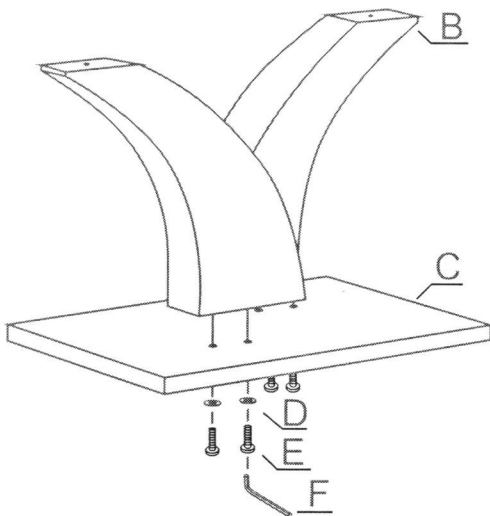

step 2

