

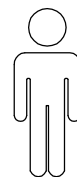

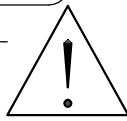

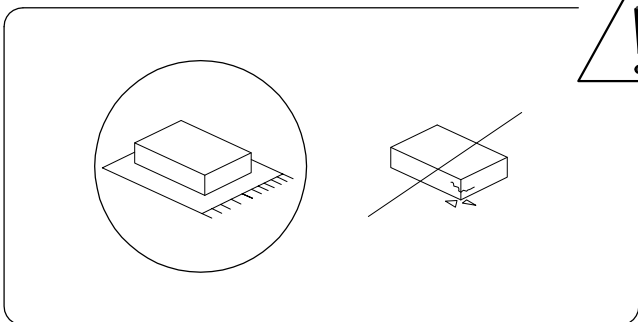

30'

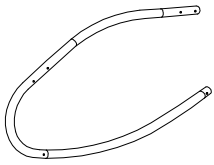

1

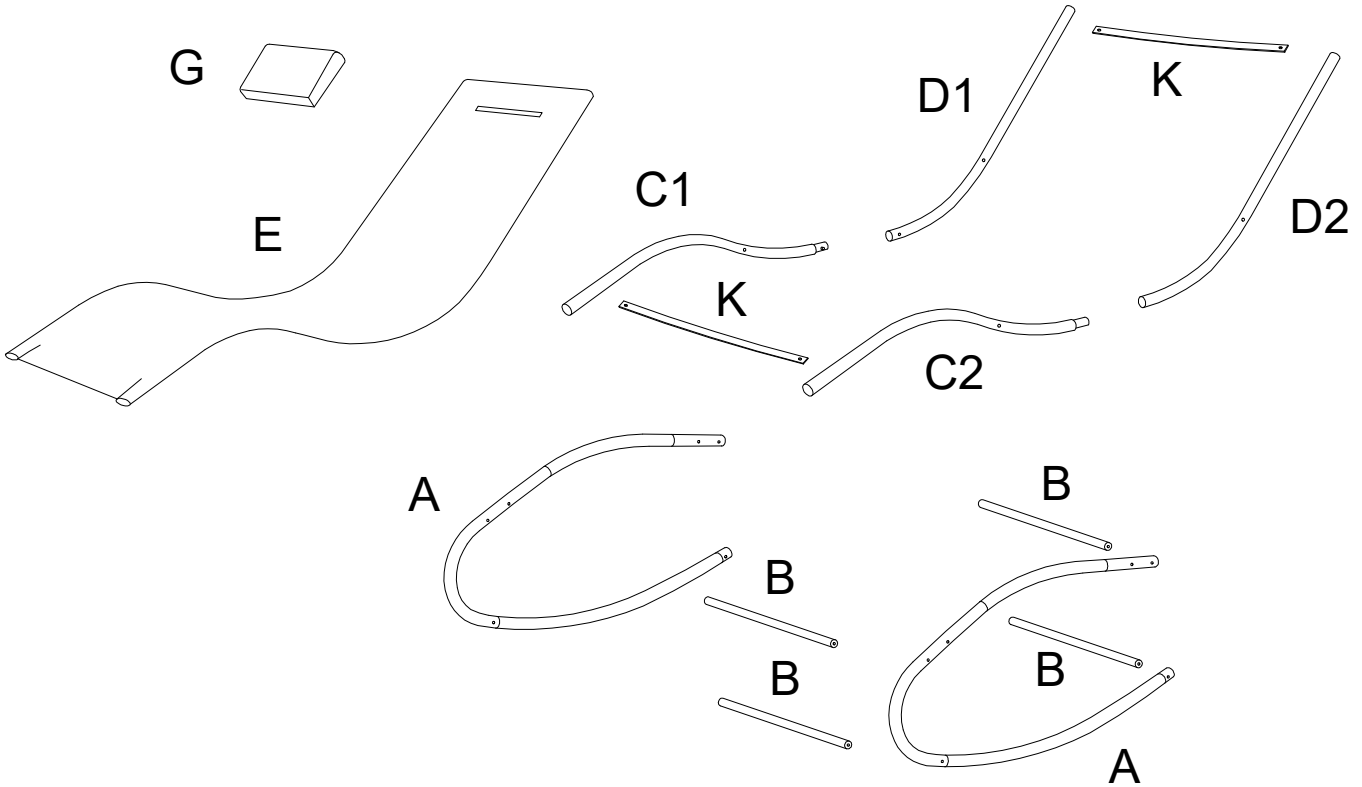
<b>A</b>	<b>B</b>	<b>C1</b>	<b>C2</b>
			
<b>x 2</b>	<b>x 4</b>	<b>x 1</b>	<b>x 1</b>

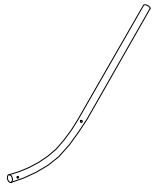
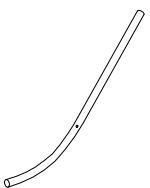
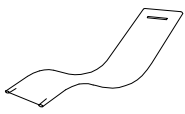
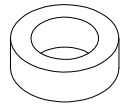
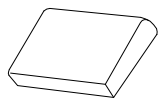
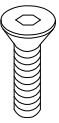
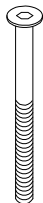
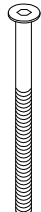
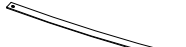

<b>D1</b>	<b>D2</b>	<b>E</b>	<b>F</b>	<b>G</b>
				
<b>x 1</b>	<b>x 1</b>	<b>x 1</b>	<b>x 4</b>	<b>x 1</b>
<b>H</b>	<b>I</b>	<b>J</b>	<b>K</b>	<b>L</b>
				
<b>x 4</b>	<b>x 8</b>	<b>x 4</b>	<b>x 2</b>	<b>x 1</b>

1

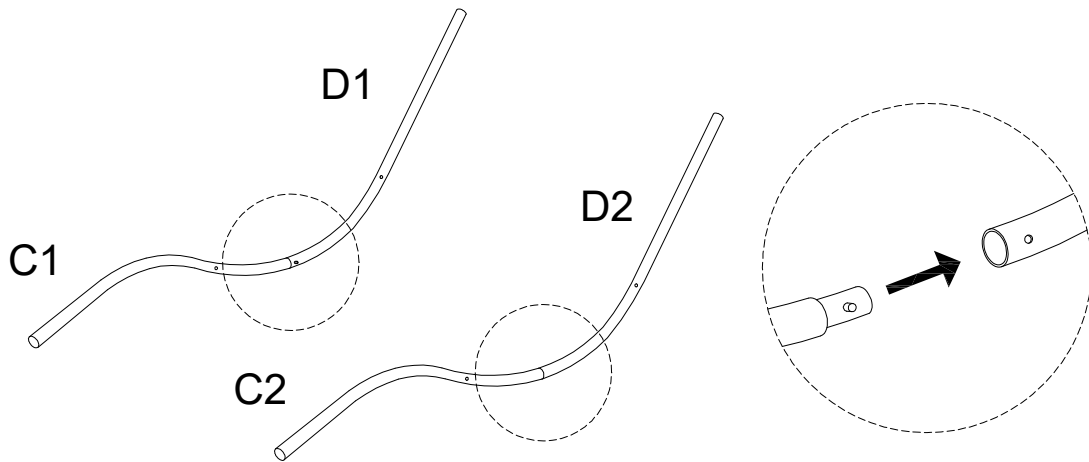
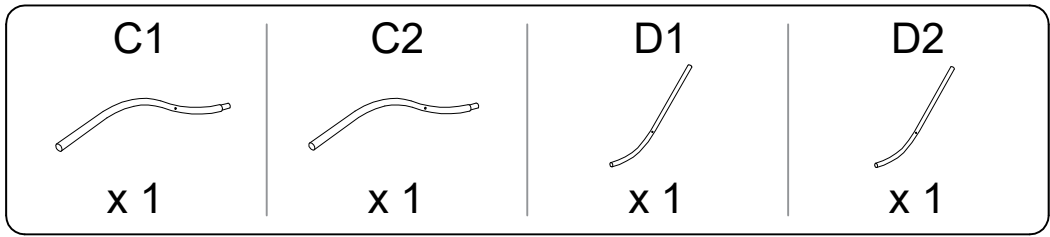

2

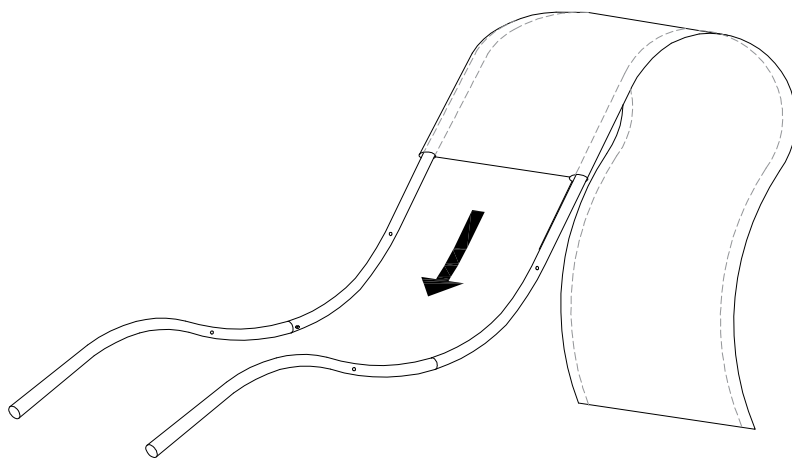
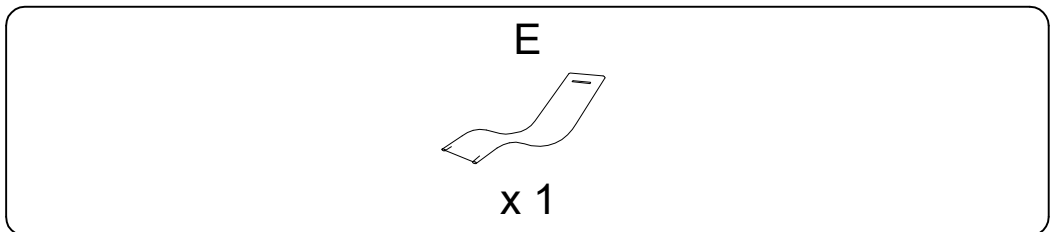

3

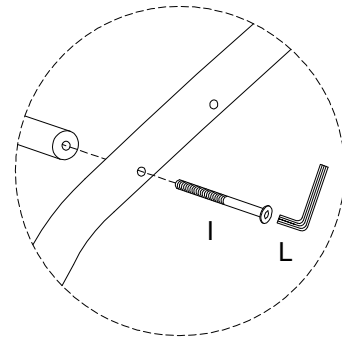
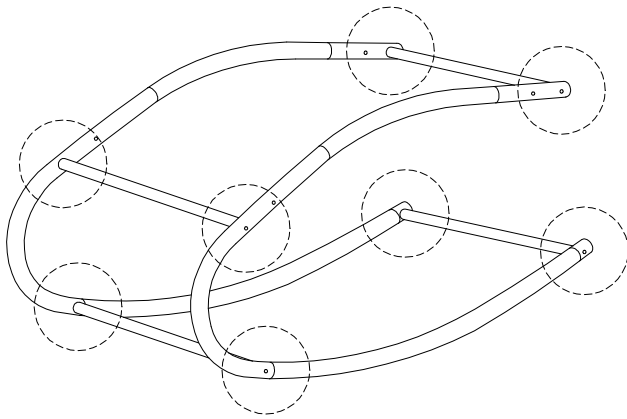
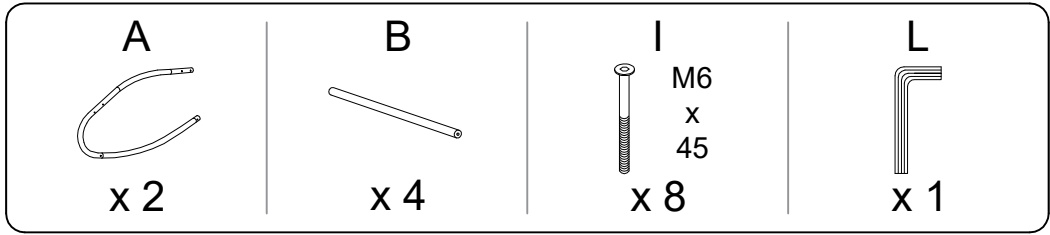

4

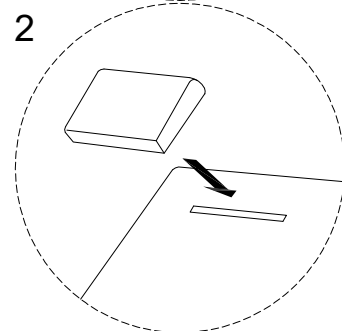
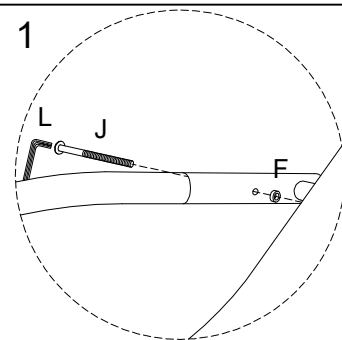
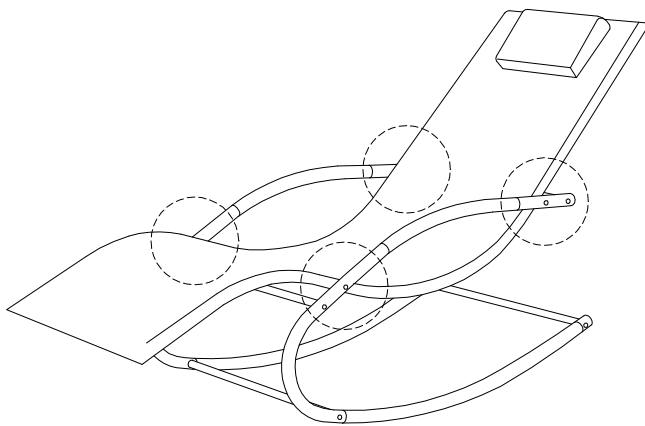
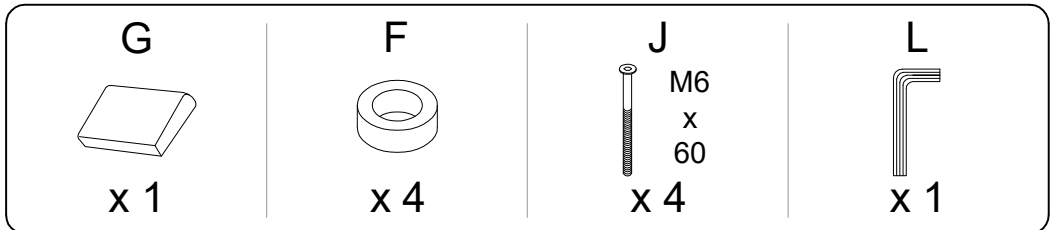

5

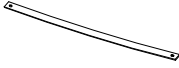
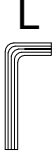
<p>H M6 x 20 x 4</p> 	<p>K x 2</p> 	<p>L x 1</p> 
--	--	--

