

User Manual Inflatable Bouncer House AMM005195_A101_US

THIS INSTRUCTION BOOKLET CONTAINS **IMPORTANT** SAFETY INFORMATION. PLEASE READ AND KEEP FOR FUTURE REFERENCE.

Contact our friendly customer service department for help first.

Replacements for missing or damaged parts will be shipped ASAP!

MADE IN CHINA

AKEYDIY - A Key to Unlock Your DIY Potential

AKEYDIY was founded in 2020 with a strong commitment to nurturing children's hands-on abilities and encouraging them to explore, discover, and experience different worlds through active and imaginative play. The founder, George Akey, is a young man who is not only a father of two children but also deeply passionate about DIY. He firmly believes that every child has immense creative potential, and with the right opportunities and tools, everyone can unlock their DIY potential.

The inspiration for George's first product came from children's dreams of creating their own costumes. However, at that time, the quality of heat press machines available on the market varied greatly, and the prices were discouraging. Determined to fulfill kids' dreams, George Akey conducted extensive research on heat transfer technology, continuously improving and perfecting it. After months of effort, he finally manufactured a durable and user-friendly machine.

This machine became like a key, unlocking infinite creative potential for DIY enthusiasts. The brand slogan, "A Key to Unlock Your DIY Potential," embodies the mission and goal of AKEYDIY. It symbolizes the brand's commitment to providing high-quality tools, equipment, and entertainment products that inspire individuals to unleash their creativity, helping them realize their DIY potential and build their dream projects.

Over time, the AKEYDIY brand gradually grew and expanded. In addition to the heat press machine, they introduced various products such as bounce houses and water slides, aimed at helping families create more joyful moments. AKEYDIY is dedicated to providing opportunities for people to bring their creative ideas to life, allowing each individual to find enjoyment and a sense of accomplishment in the DIY process.

Customer support

If you need help regarding product issues, after-sales service, or other relevant problems, please contact us via email: support@akeydiy.net, and provide the following information:

- Order ID
- Problem Description



Inflatable Bouncer House

User manual
Ages: 3-8 years

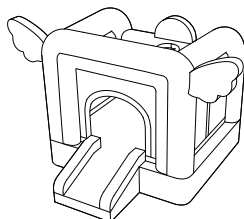

106.2"L x 84.6"W x 79.5"H
Approximate Size Inflated

⚠ WARNING: FAILURE TO FOLLOW THESE INSTRUCTIONS COULD RESULT IN SERIOUS INJURY OR DEATH.

Do not use extension cords with this product. Outdoor use only.
Read all instructions before assembling this inflatable device. Keep instructions for future use.

⚠ WARNING: USERS MUST BE CAREFUL A BOUNCY ORIENTATION WITH REGARD TO THE SUN. The sliding surface should not be located facing the sun as it can dazzle children when using the bouncy.

PART LIST

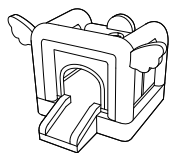

A) 1 Inflatable Bouncer House



B) 1 Carrying Bag



C) 6 Bouncer Stakes



D) 4 Blower Stakes

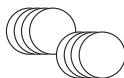

E) 8 Repair Patches

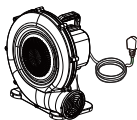

F) 1 Blower



G) 1 Inflatable Ball



H) 1 Inflatable Ball Pump



I) 1 Six-color Beach Ball



J) 1 Inflatable Bopper



K) 1 Set of Catch Ball Game



L) 1 Pack Of Macaroon Colored Balloons

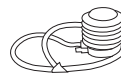

M) 1 foot pump

⚠ SAFETY WARNINGS: SET UP

ADULT SUPERVISION AND SETUP REQUIRED. This product should be inflated or deflated only by a competent adult. Follow all instructions provided.

WARNING! Falls onto hard surfaces can result in head or other serious injuries. Never place on concrete, asphalt, wood, packed earth, or other hard surfaces.

Carpet over hard floors may not prevent injury.

- ⚠ **WARNING! Only for domestic use.** Intended for outdoor domestic family use only. Not for use in public areas or as a rental.
- Product is heavy. Use caution when lifting.
- Product should never be dragged across concrete, pavement or other rough surfaces.
- **WARNING!** Keep away from fire. Keep fabric clear of all flame and ignition sources.
- Do not set up in windy or rainy conditions: sudden gusts of wind may lift the product off the ground.
- Product can be installed in any orientation in relation to the sun, since there are no metal components or surfaces that can absorb excessive solar radiation.
- Set-up in outdoor location only that meets the following criteria:
 - Place on level ground and firm grass or soil to allow proper use of stakes.
 - Placing on slanted or uneven surfaces may cause the product to tip.
 - Stakes should be placed at an angle for better anchorage, should be driven under the ground to prevent tripping.
 - Minimum clearance zones: Place at least 2m away from any other objects.
 - Objects to be avoided include but are not limited to fences, buildings, trees, overhead branches, laundry lines, electrical wires, walls, or bodies or sources of water.
 - Make sure the area around the product is secure by adding safety barriers, if necessary, to keep young children and pets from gaining access.
 - Electrical cord must not be passed under the air filled devices (inflatable Bouncer with Slide) and interfere with its operation.
- The Bouncer with Slide uses a main powered blower (air pump) to maintain pressure, only to be used by an adult.
- Do not use extension cords with this product. Set up as close to power source as possible. The blower should be securely anchored to the ground before use.
- **CAUTION:** the blower is capable of moving large volumes of air very quickly. Place the blower in an area where it will not draw in dirt or leaves. Keep blower and power cord away from children, water and traffic.
- **ATTENTION:** Blower should remain on and continuously inflate bouncer during use. Airflow through seams is normal.
- Do not use the product if wind speed exceeds 30km/h.
- Do not consume food, drink and gum on this product.

MINIMUM CLEARANCE ZONES

MINIMUM CLEARANCE ZONES

Make sure that there is a 2m obstacle-free zone around the product, including a fence, garage, house, overhanging branches, laundry lines or electrical wires.

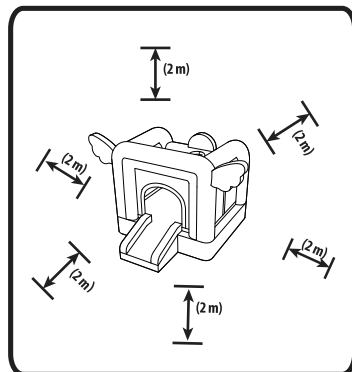

BOUNCER PLACEMENT

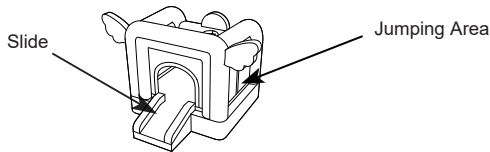

Designate a flat, level surface that allows for 2m of minimum clearance around the Bouncer.

NOTE: Do not place the Bouncer with slide on a hard surface like asphalt, concrete or packed earth as both serious bodily injury and damage to the Bounce could result.

ASSEMBLY AREAS

- Make sure the assembly area is flat and level and is free of rocks, sharp objects or other obstructions.
- Do not set up the Bounce on a slope or incline.
- Do not set up the Bounce on hard-packed earth, asphalt, decking or any hard surface as doing so may result in physical injury and/or damage to the Bouncer.
- Once the Bounce inflated or filled with water, do not attempt to drag it to another location.
- Check your local county or city regulations for requirements on securing the pool.
- Secure the pool from unauthorized use.

SAFETY WARNINGS: Failure to follow these instructions could result in serious injury or death.



Maximum number of children: 3



years Age



Total weight limit on slide and pool: 231 lbs.



Maximum individual height: 5 Ft. (152 cm)



Adult supervision required. Do not leave children unattended.



No sharp objects.



No shoes, no glasses.



No flipping.



Do not slide head first.



No wrestling.



Individual weight limit: 77 lbs.



No hands or feet on net.



Do not use in windy conditions.



Do not leave out in rain.



Do not allow children to touch fan or electrical cord.



Must be anchored using stakes.

- Constant, competent adult supervision of children and other young users is required at all times.
- Keep the area around the product clean, and clear of objects, to prevent slips and falls.
- Do not allow children to play in the product until it is fully inflated.
- Do not allow children to play on if wet. Thoroughly dry before use.
- This is not an aquatic toy. It is not to be used in water.
- Instruct children on proper use of this product.
- Children should not wear loose or baggy clothing, scarves, hoods or clothing with drawstrings or long cords while playing on this product.
- Children must remove helmets, headgear, shoes and glasses, as well as any sharp objects from their pockets, as they may puncture the bouncing surface.
- Toys and other objects should never be allowed inside the bouncer.
- Instruct children not to attach items to the product that are not specifically designed for use with the equipment, such as but not limited to, jump ropes, clothesline, pet leashes, cables and chains as they may cause a strangulation hazard.
- Keep pets away from product.
- Children should bounce away from others, and stay away from openings and side walls.

- Children should not jump onto or off the product.
 - Total weight of children must not exceed 231 lbs. (105 kg) No more than 3 children should play on the Bouncer at the same time.
 - Do not allow children to play together who are unevenly matched in weight and height.
 - Before and during use, check for air loss. Check blower is properly connected.
 - Always check the product and all its anchorage points before and during use, and to re-secure as appropriate.
 - After inflation, the blower should run continuously while children are playing.
 - Prior to deflating, remove all children.
 - Always deflate product after use, and store indoors.
 - To be used on soft ground only.
 - Users must be discouraged from attempting any unauthorized modification.
- The product should be periodically examined for potentially unsafe conditions such as: damaged cord, plug, housing, or parts, and that in the event such damage is found, the product should not be used until properly repaired. Never leave the fan outside in the rain or elements when not in use. Refer to the instructions for set-up, storage maintenance and care, openings and side walls.

SET UP



CAUTION: Heed all signs and warning labels on the blower motor.

⚠ BLOWER CAUTIONS:

- Do not open or try to service the blower. If blower needs servicing, take it to a reputable dealer.
- Clearly mark the path of the power cord to avoid tripping or damage from yard equipment such as lawn mowers, etc.
- Do not leave blower unattended.
- Do not allow blower to be used or played with by children.
- Do not cover the air intakes when the blower is being used and do not insert small objects into any part of the blower.
- **WARNING** - Electrical Hazard - Do not use extension cords with this product.
- Disconnect the blower from the power source when moving the slide.
- **WARNING** - To reduce the risk of fire or electric shock, do not use this blower with any solid - state speed control device
- The blower should be securely staked to the ground before use.

- 1 Remove Bouncer from its packaging



- 2

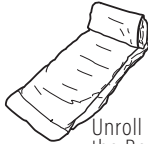

Unroll and unfold the Bouncer in the center of the designated area.

- 3

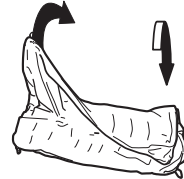

- 4



- 5

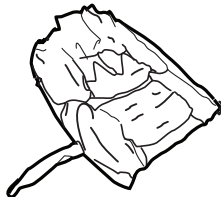

- 6
1. Attach longer fabric tube to blower unit making sure the tube is not twisted.
 2. Wrap drawstring around the tube and end of blower once, and tie tightly in place.
 3. Tie and bind the short fabric tube with the rope before inserting air.



INFLATION & STAKING

1

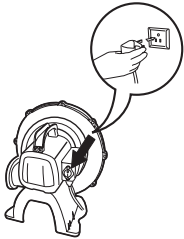

Switch power on.

2

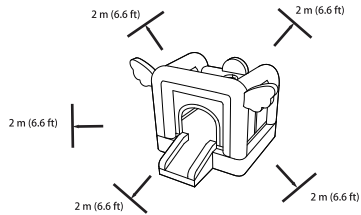

Blower should remain on and continuously inflate bouncer during use. Airflow through seams is normal. Do not try to seal or repair seams.
NOTE: Dispose of tissue paper packed inside bouncer after inflation.

- 3 Secure the Bouncer to the ground with the provided stakes. To prevent tripping, pull the stake loops all the way out, then drive stakes completely into the ground.

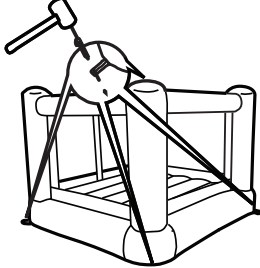

- 4 Secure the blower to the ground with the provided stakes.

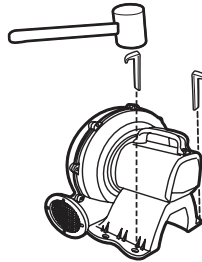

DEFLATION & STORAGE

- 1 Turn off the blower and unplug it from the outlet.

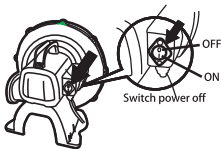

2

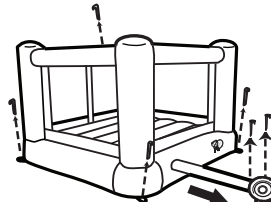

- 3 Untie the drawstring from the Intake Tube and allow the Bouncer to fully deflate.



- 4 Fold over only

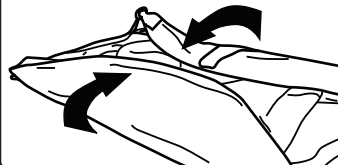

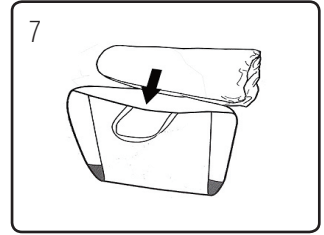
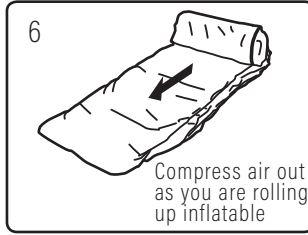

REPAIR PATCH INSTRUCTIONS



WARNING: Repair patches must be applied by adults only.

KEEP OUT OF REACH OF CHILDREN.

INSTRUCTION:

1. Deflate the item, clean the area and allow to dry thoroughly.
2. Cut a portion of the patch to the size needed and round the corners. (See Fig).
3. Remove the adhesive backing from the patch material, position the patch over the damaged area and smooth out any bubbles
4. Allow to sit for 30 minutes before re-inflating

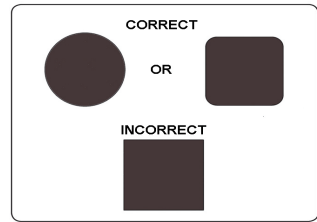

INSTRUCTIONS FOR BOUNCER MAINTENANCE

- As an outdoor product, the bouncer is subject to wear and deterioration. Inspect for signs of fabric failure; weak or torn surfaces must be repaired promptly.
- To keep the product clean: wipe the bouncer or blower using a dry cloth or a cloth dampened with a neutral, non-flammable, nontoxic cleaning and sanitizing solution or pure water.
- Product should never be stored wet. Allow to dry before rolling up.

DISPOSAL

- Disassemble and dispose of the equipment in such a manner that no hazardous conditions exist at the time the equipment is discarded.
- Blower should be returned to a collection center.



'Let's care for the environment!'

The wheeled bin symbol indicates that the product must not be disposed of with other household waste. Please use designated collection points or recycling facilities when disposing of the item.

INSTRUCTIONS FOR BLOWER MAINTENANCE

- Blower must be unplugged before servicing.
- If the supply cord is damaged, it must be replaced by qualified persons in order to avoid a hazard.
- Product should be periodically examined for potentially unsafe conditions such as damaged cord, plug, housing, or parts, and that in the event such damage is found, the product should not be used until properly repaired. If these checks are not carried out, the product could overturn or otherwise become a hazard.
- The blower does not require any lubrication and has no user serviceable parts. Do not attempt to service the blower.
- Do not immerse the fan in water. To clean, wipe with a damp cloth.
- Regularly check the intake and output openings and keep free of dirt, leaves, etc.
- When not in use, store the blower indoors in a dry place.
- Store the blower upright on a stable surface.
- Loosely coil the cord and place it beside the blower.
- When in use, do not place the cord across traffic areas, water or damp areas.
- The blower is a high volume blower, and is capable of moving large volumes of air very quickly. Place the blower in an area where it will not draw in dirt or leaves.

Please keep this manual as it contains important information.