

Assembly Instructions







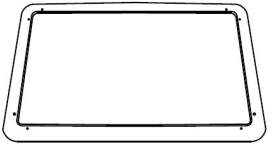

For any missing hardware, damaged parts and other problems.

*Don't fully tighten all the bolts till the very end!

PRE-ASSEMBLY PREPARATION:

- Please read through the instructions before beginning assembly.
- Clear out the space for assembly and lay out all of the parts based on the Parts List, extra room will allow you to easily determine if all the pieces are present.
- Keep small parts and pieces away from children until fully assembled.

Part no.	Part	QTY	Image	Part no.	Part	QTY	Image
A	Table top	1		D	Bolt (M6*15mm)	12	
B	Table leg	4		E	Washer M6	12	
C	Tray	1		F	Allen wrench	1	

Step 1: Attach legs B to table top A with 8pcs bolts D and 8pcs washers E, using Allen wrench F. Note: Please don't tighten the bolts.



Bolt D x 8
M6*15mm

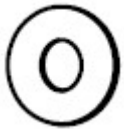

Washer E x 8

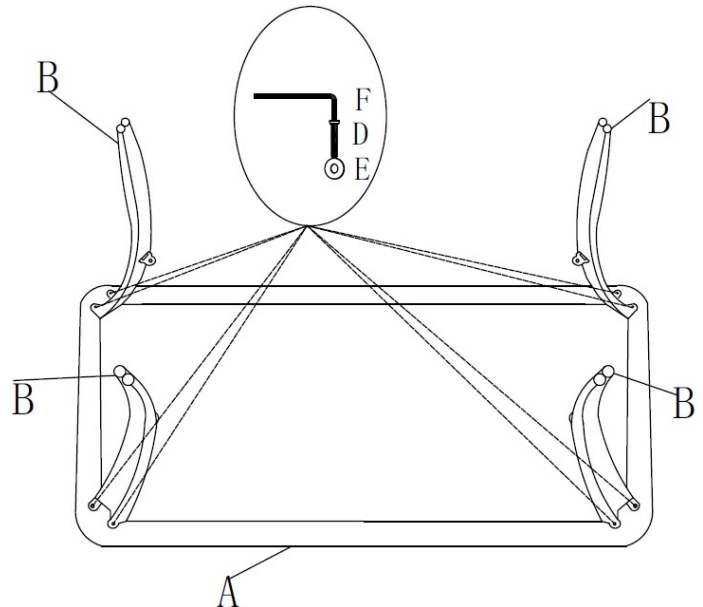

Step 2: Attach legs B to tray C with 4pcs bolts D and 4pcs washers E, using Allen wrench F. Note: Please fully tighten all the bolts. Table is ready for use.



Bolt D x 4
M6*15mm

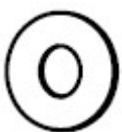

Washer E x 4

