

INSTRUCTION

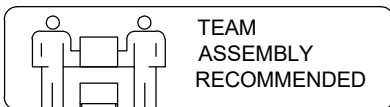

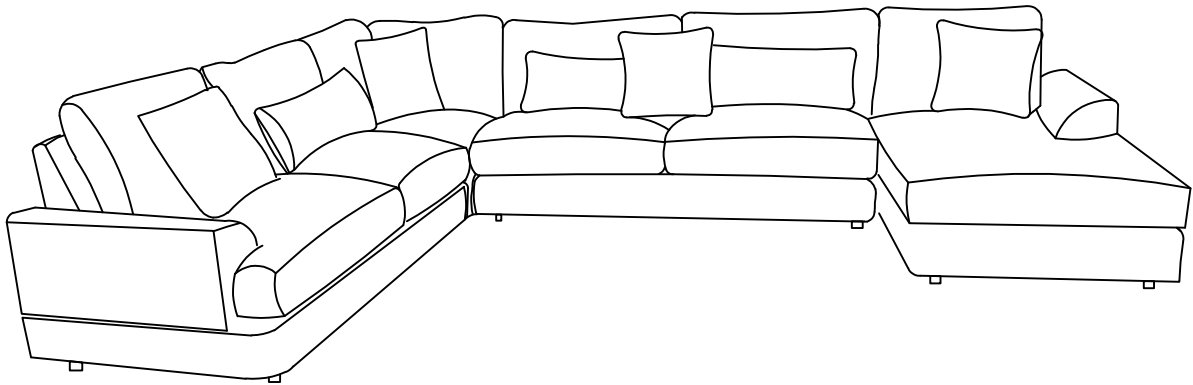

Notice: The resilience performance of this product is affected by the weather. Please do not worry about it when you receive the product. 72 hours are required for the product to resilient.

An ironing machine can iron the wrinkles.













Sectional Sofa











COMPONENT LIST

NO.	DRAWING	QTY	DESCRIPTION
J		1	Corner-Frame
M		1	Corner-Back
O		1	Corner-Back Cushion
N		1	Corner-Back Cushion
K		1	Corner-Cushion
X		4	Leg
Z		4	Insert
W		2	Throw Pillow
V		1	Rectangle Pillow







COMPONENT LIST

NO.	DRAWING	QTY	DESCRIPTION
P		1	Loveseat-Frame
Q		1	Loveseat-Back
T		1	Loveseat-Seat Cushion
S		1	Loveseat-Seat Cushion
R		2	Loveseat-Back Cushion
Z		4	Insert
X		4	Leg
Y		1	Screw
A1		1	Washer
B1		1	Allen key



COMPONENT LIST

NO.	DRAWING	QTY	DESCRIPTION
A		1	3-seater-Frame
B		1	3-seater-Back
C		2	3-seater-Back Cushion
D		2	3-seater-Seat Cushion
Y		1	Screw
X		4	Leg
Z		2	Insert
W		2	Throw Pillow
V		2	Rectangle Pillow
A1		1	Washer

COMPONENT LIST





NO.	DRAWING	QTY	DESCRIPTION
E		1	Chaise-Frame
F		1	Chaise-Back
I		1	Chaise-Cushion
G		1	Chaise-Back Cushion
L		1	Corner-Back
Z		4	Insert
X		4	Leg

COMPONENT LIST

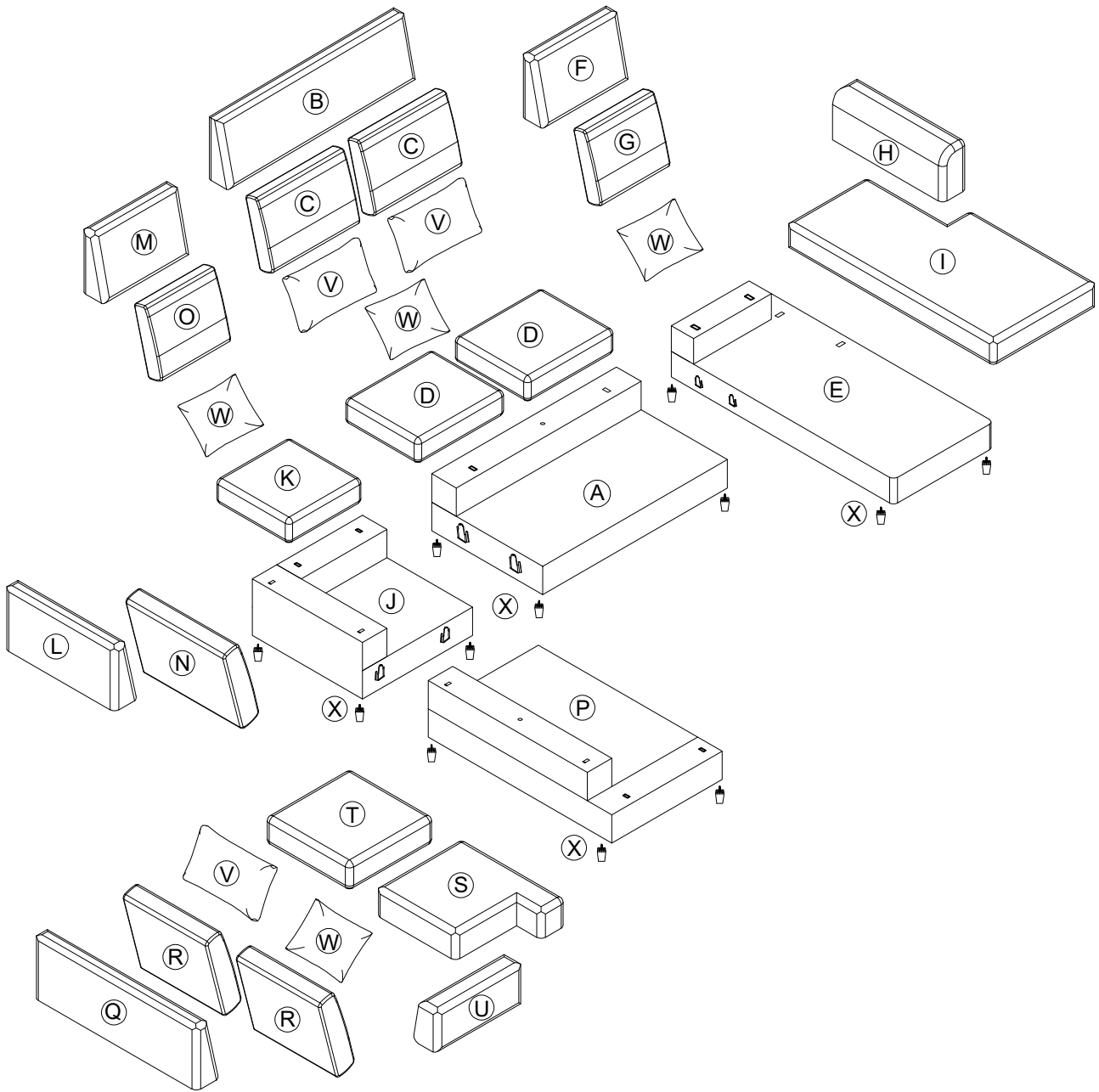
NO.	DRAWING	QTY	DESCRIPTION
H		1	Chaise-Arm
U		1	Loveseat-Arm

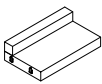
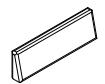
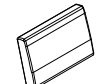
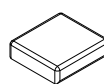
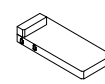
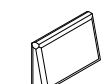
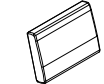
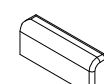
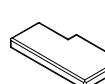
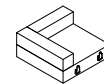
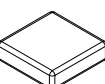
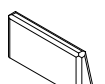
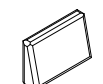
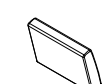
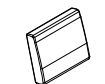
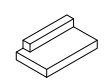
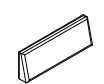
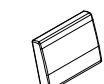
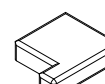
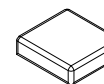
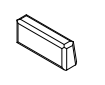
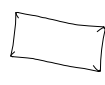
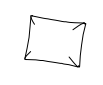
PARTS LIST

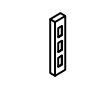

 3-seater-Frame X 1PC	 3-seater-Back X 1PC	 3-seater-Back Cushion X 2PCS	 3-seater-Seat Cushion X 2PCS	 Chaise-Frame X 1PC	 Chaise-Back X 1PC	 Chaise-Back Cushion X 1PC	 Chaise-Arm X 1PC	 Chaise-Cushion X 1PC	 Corner-Frame X 1PC
 Corner-Cushion X 1PC	 Corner-Back X 1PC	 Corner-Back X 1PC	 Corner-Back Cushion X 1PC	 Corner-Back Cushion X 1PC	 Loveseat-Frame X 1PC	 Loveseat-Back X 1PC	 Loveseat-Back Cushion X 2PCS	 Loveseat-Seat Cushion X 1PC	 Loveseat-Seat Cushion X 1PC
 Loveseat-Arm X 1PC	 Rectangle Pillow X 3PCS	 Throw Pillow X 4PCS	 Leg X 16PCS	 Screw X 2PCS	 Insert X 14PCS	 Washer X 2PCS	 Allen key X 1PC		

STEP 1:

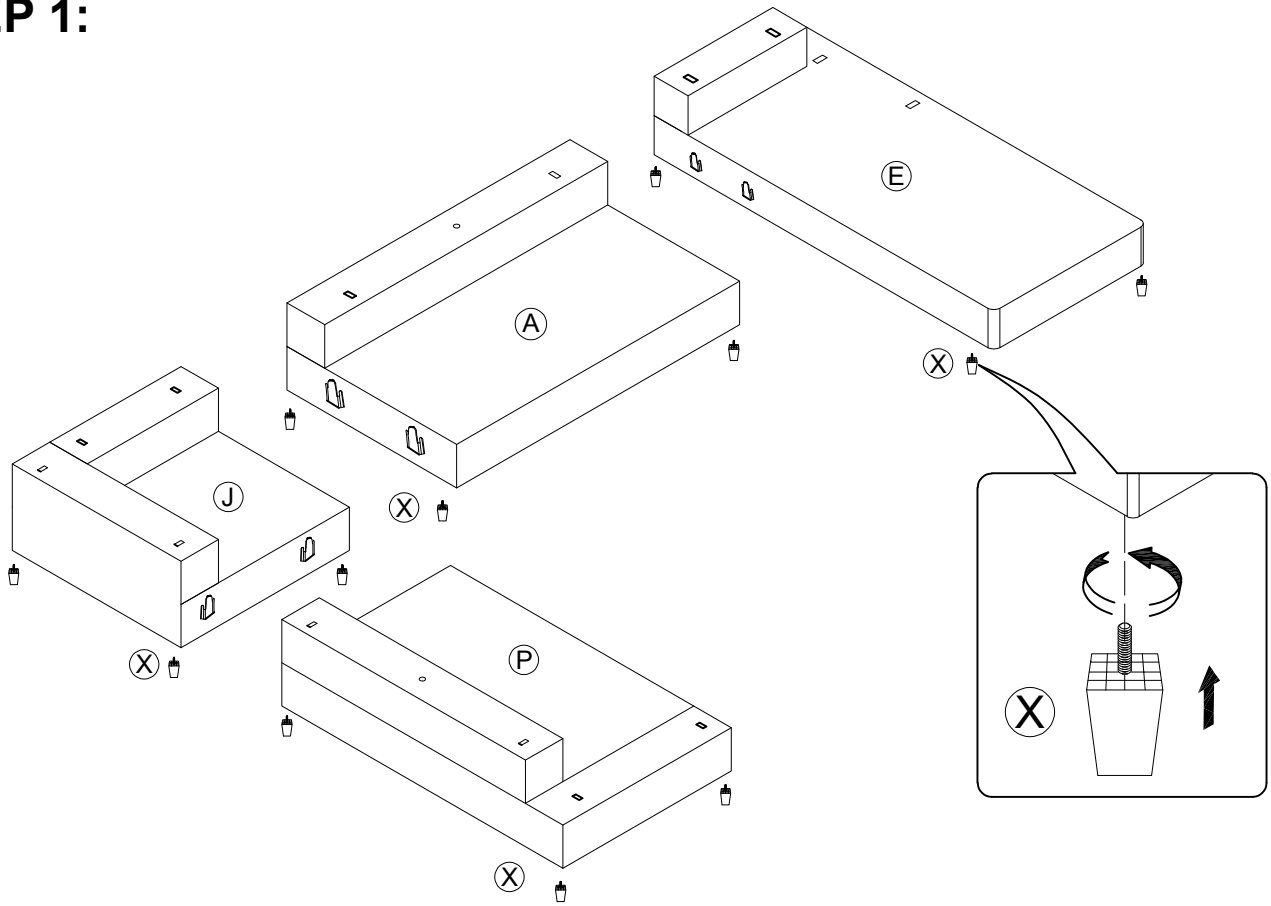

STEP 2:

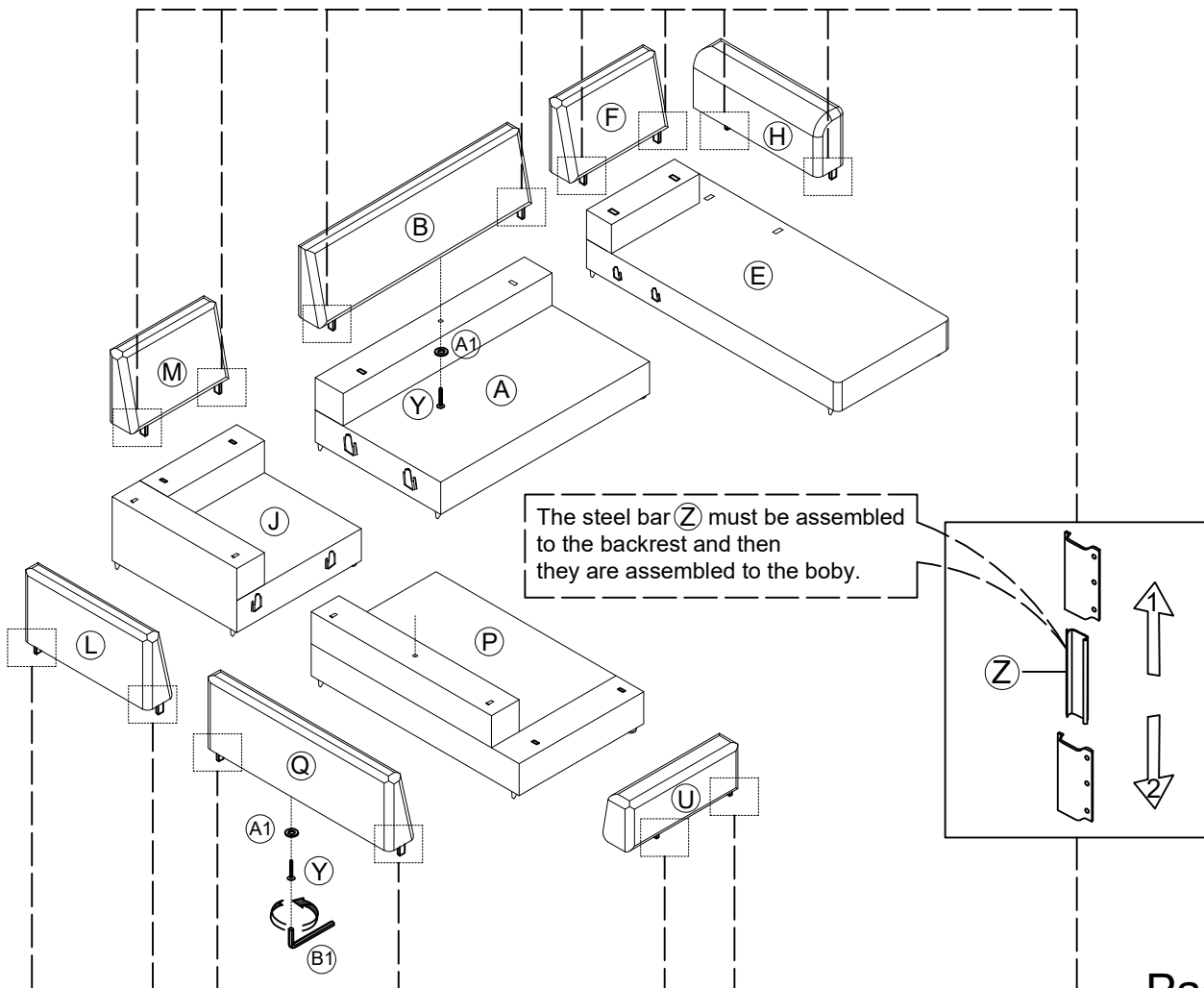

STEP 3:

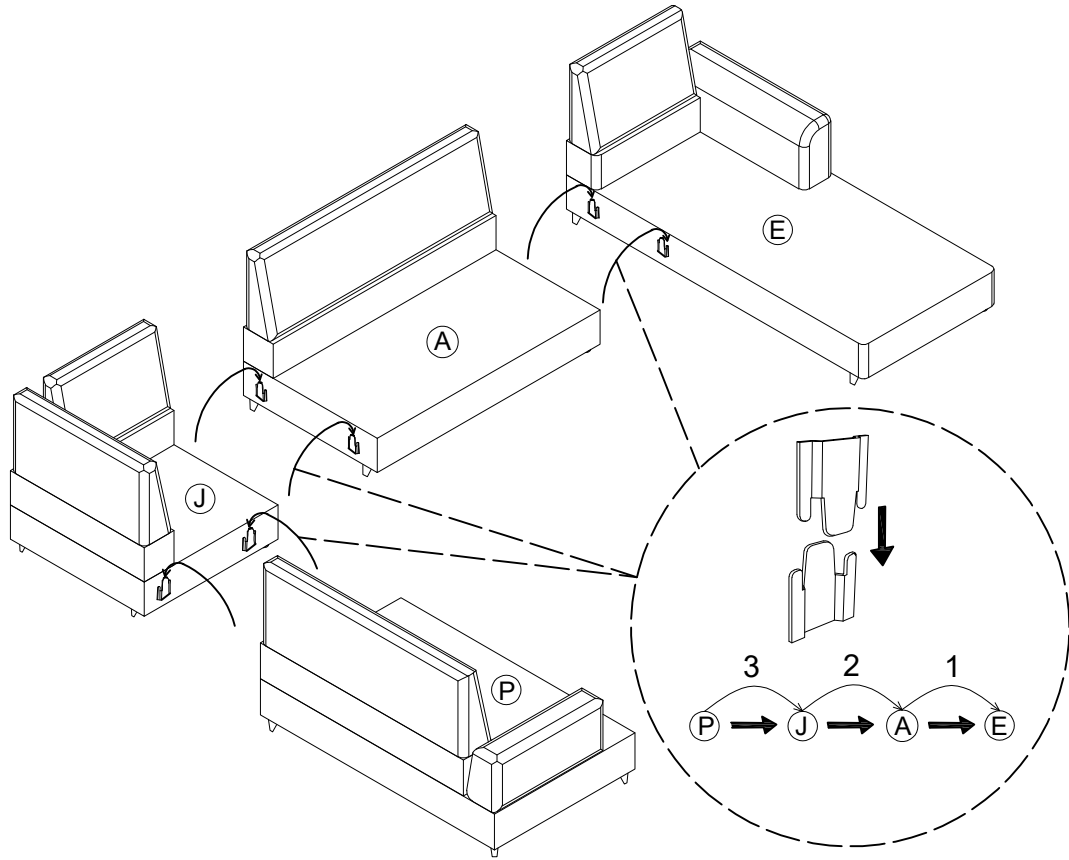

STEP 4:

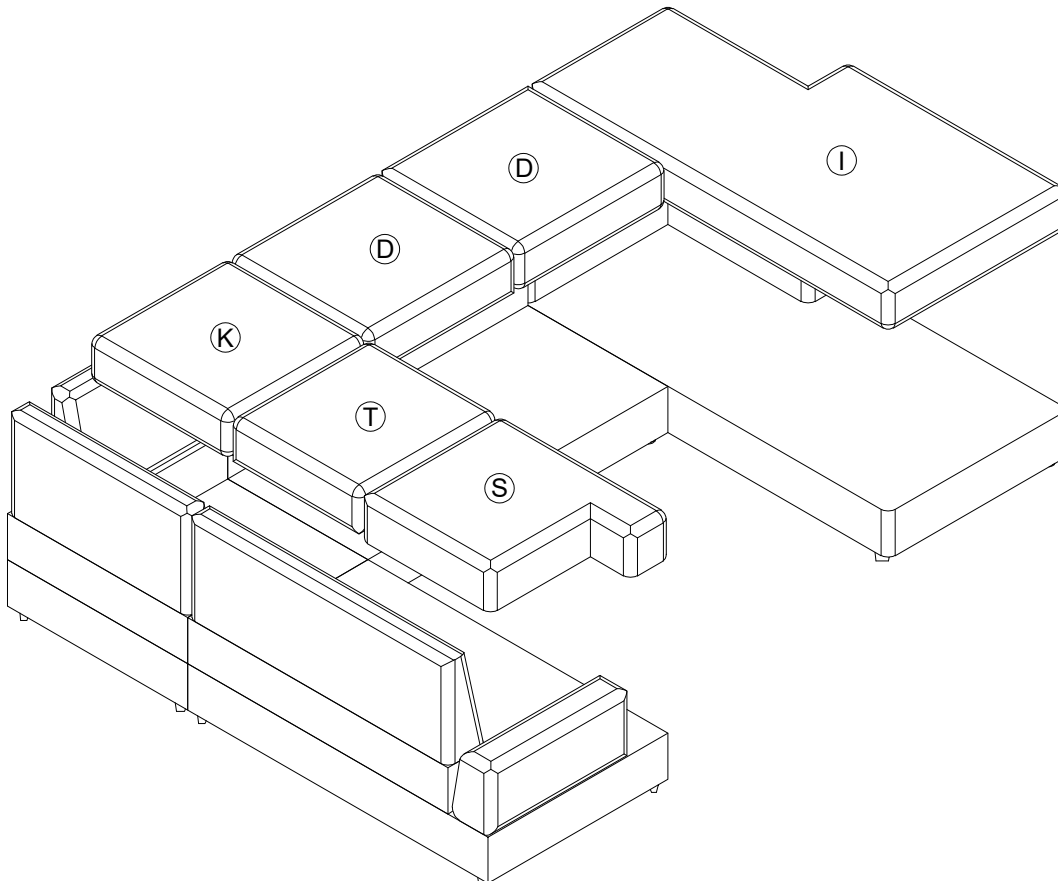

STEP 5:

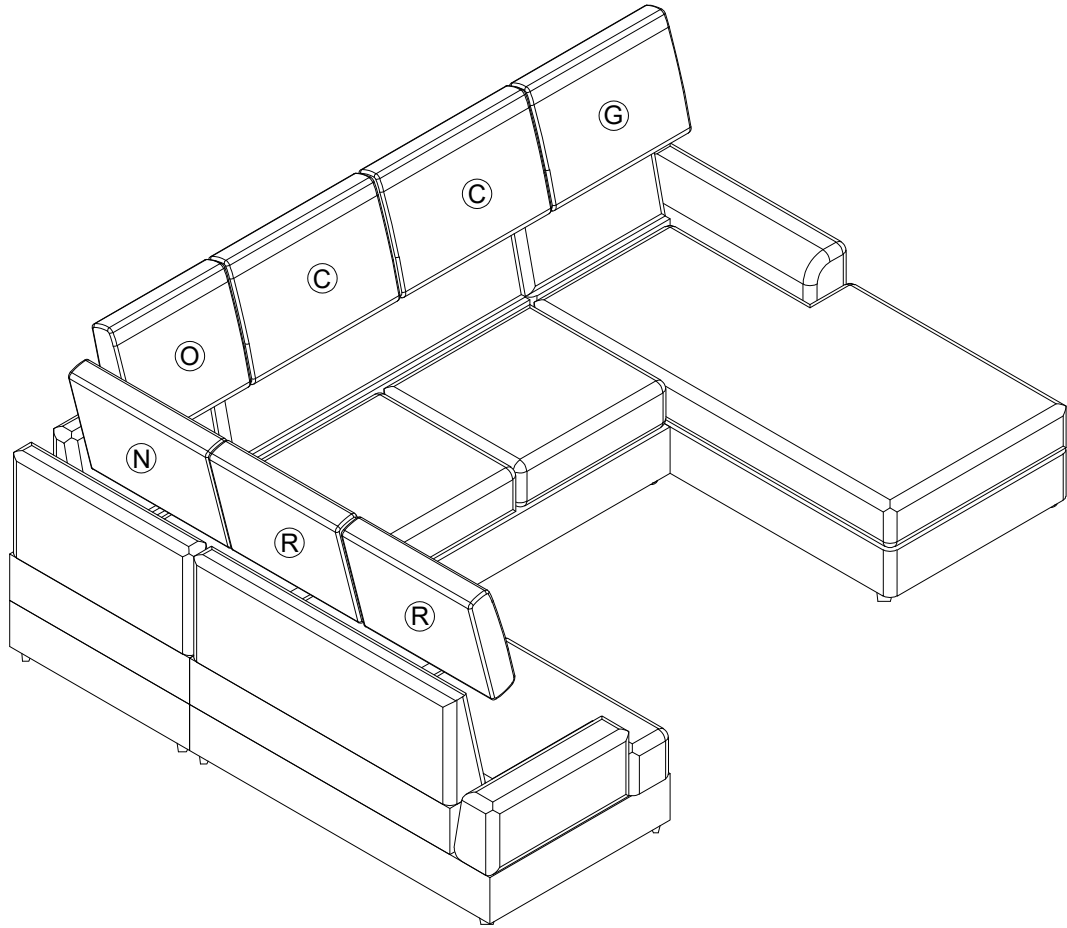

STEP 6:

