

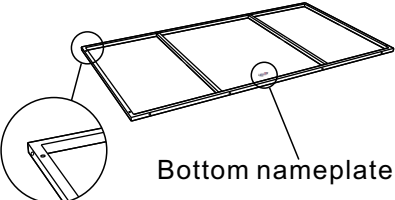

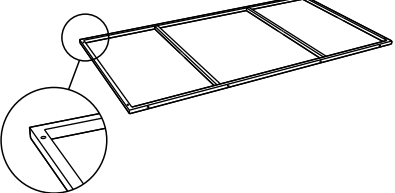

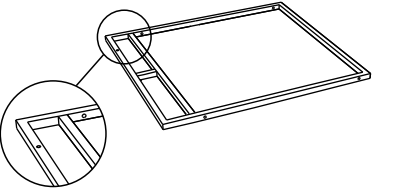

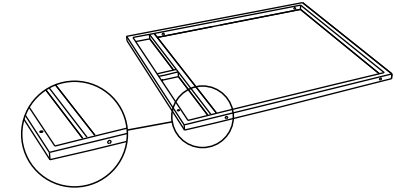

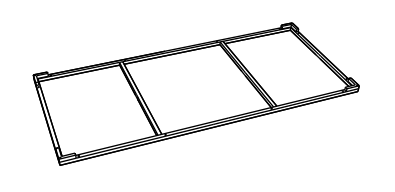
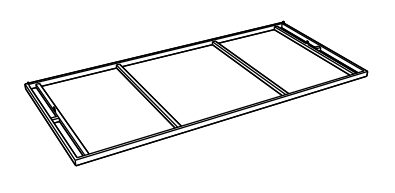

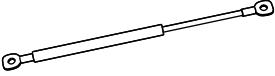
Assembly Instructions

Please read this before you proceed

A	 <p>Bottom nameplate</p>	Back panel	1pc
B		Front panel	1pc
C		Left side panel	1pc
D		Right side panel	1pc
E		Bottom panel	1pc
F		Top panel	1pc

Assembly Instructions

Please read this before you proceed

G		Gas Lift cylinder	2pcs
H		M6*35mm	18pcs
I		M6*15mm	6pcs
J		Washers	22pcs
K		Isolation column	6pcs
L		Nut	2pcs
M		Allen wrench	1pc
O		Spanner	1pc
P		Clamping knob	4pcs
Q		Liner	1pc

Assembly Instructions

- ① *Note: Please do not tighten all the screws before the products is fully installed, for it may cause assembling issues.



Velcro on top



Back screw hole



Side screw hole

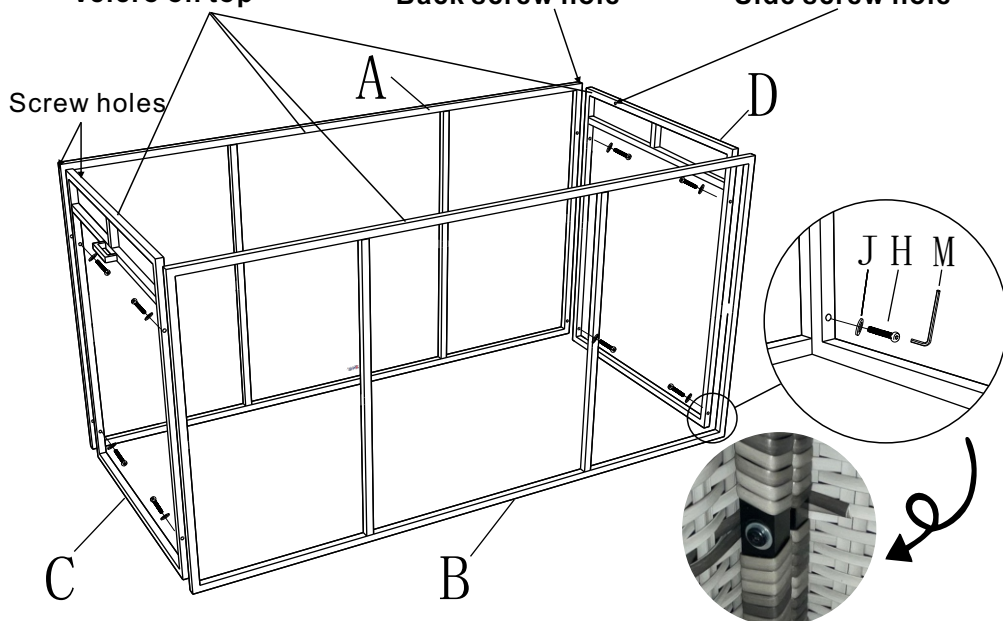

1. Use Allen wrenches (M), screws (H) and washers (J) to connect the four side panels (A) (B) (C) (D)
2. Place the side with the Velcro upwards.
3. The bolts near the Velcro on the inside of the side panels (C) (D) should be close to the back panel (A).
4. Back panel (A) and the front panel (B) are not the same. There are screw holes on the top of the back panel (A) for connecting the top panel (F)
5. Please do not tighten all the screws after connecting all side panels.

Assembly Instructions

2

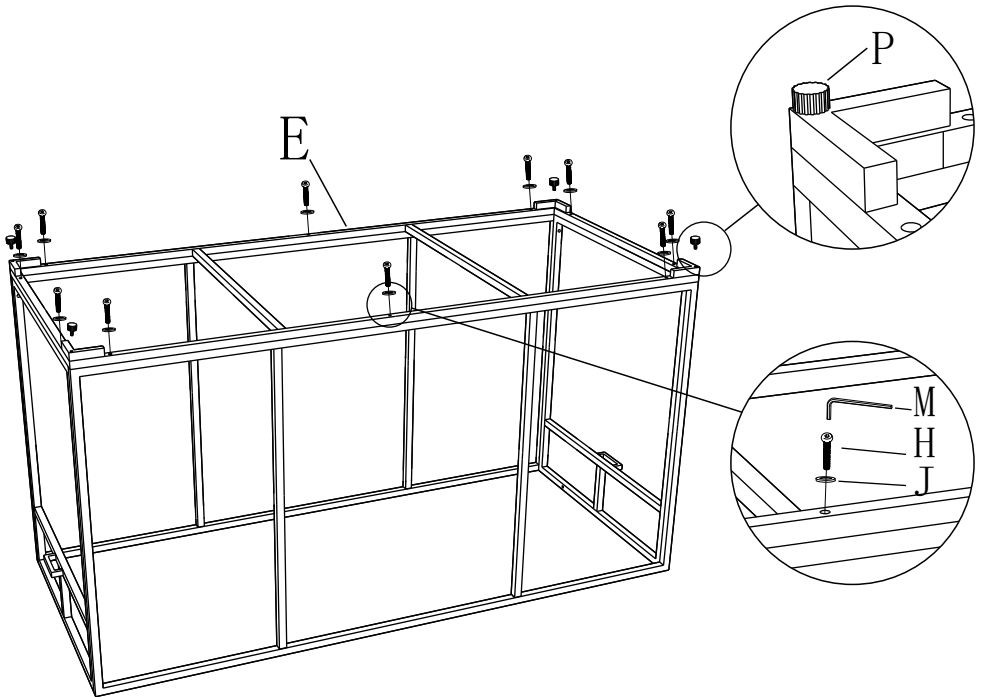

1. Turn the products upside down
2. Place the back panel (E) above the side panels
3. Use Allen wrench (M), screws (H) and washers (J) to connect the side panels and the bottom panel
4. Install the clamping knob (P) on the support foot

Assembly Instructions

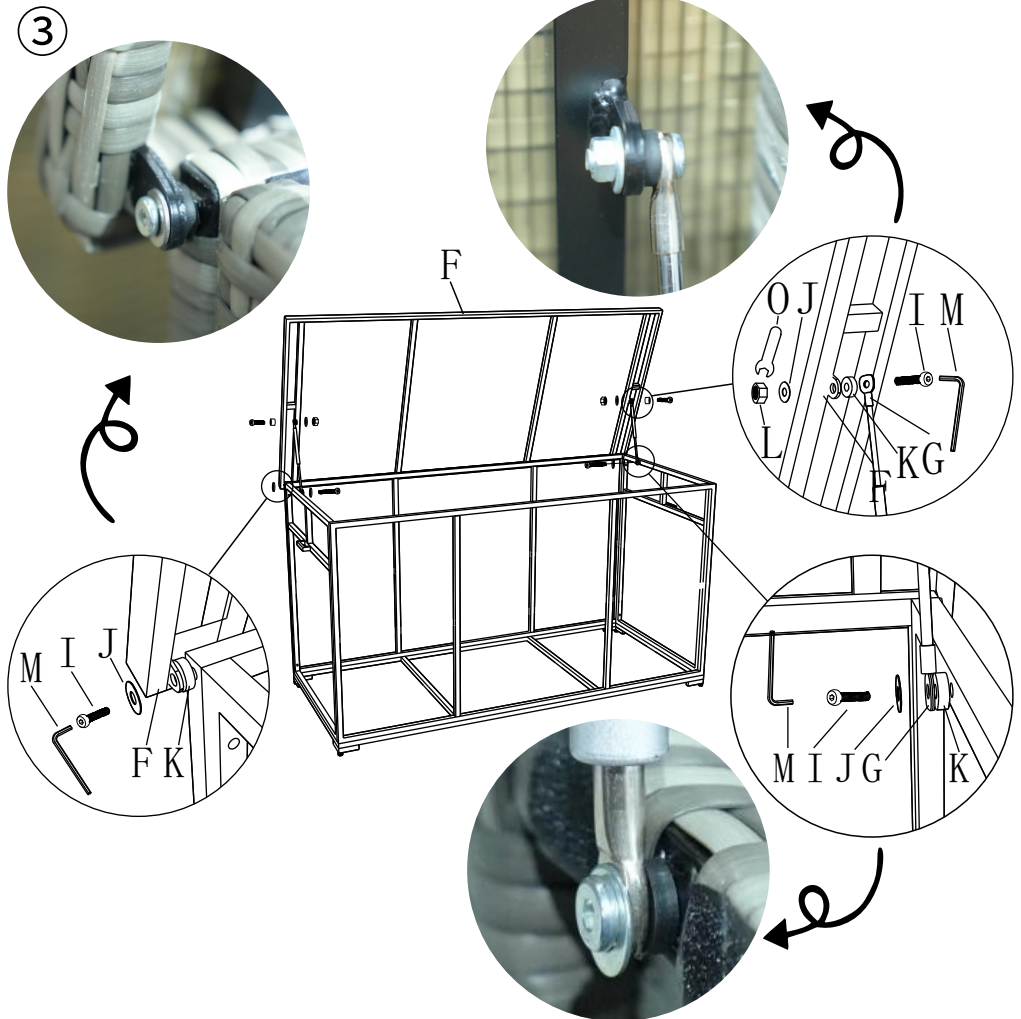

1. Turn the product upside down again so that the top is facing up
2. Use Allen wrench (M), screws (I) and washers (J) to connect the top panel (F) and the back panel (A). The Isolation column (K) needs to be placed between the connecting pieces of the back panel and the top panel (F) to avoid friction.
3. Open the lid (F), install the cylinder on the side of the lid with the side panel near Velcro .
4. Use (O)(L)(J)(K)(I)(M) to install the thicker side of the cylinder on the top plate (F), as shown in the picture
5. Use (M) (I) (J) (K) to connect the cylinder (G) to the side panels (C) (D), as shown in the picture

Assembly Instructions

④

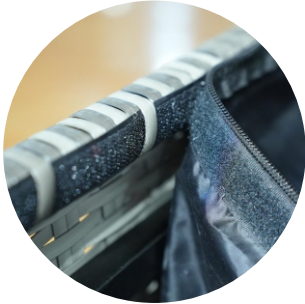

Velcro



Zip up



1. Open the liner (Q) and stick the Velcro near the zipper to the Velcro on all side panels.
2. Zip up the storage box to make it waterproof
3. When you need to take items, liner top can be stick to the Velcro on the top panel for easy putting in and out.

Congrats! You have completed assembling it-enjoy!