

ASSEMBLY INSTRUCTIONS

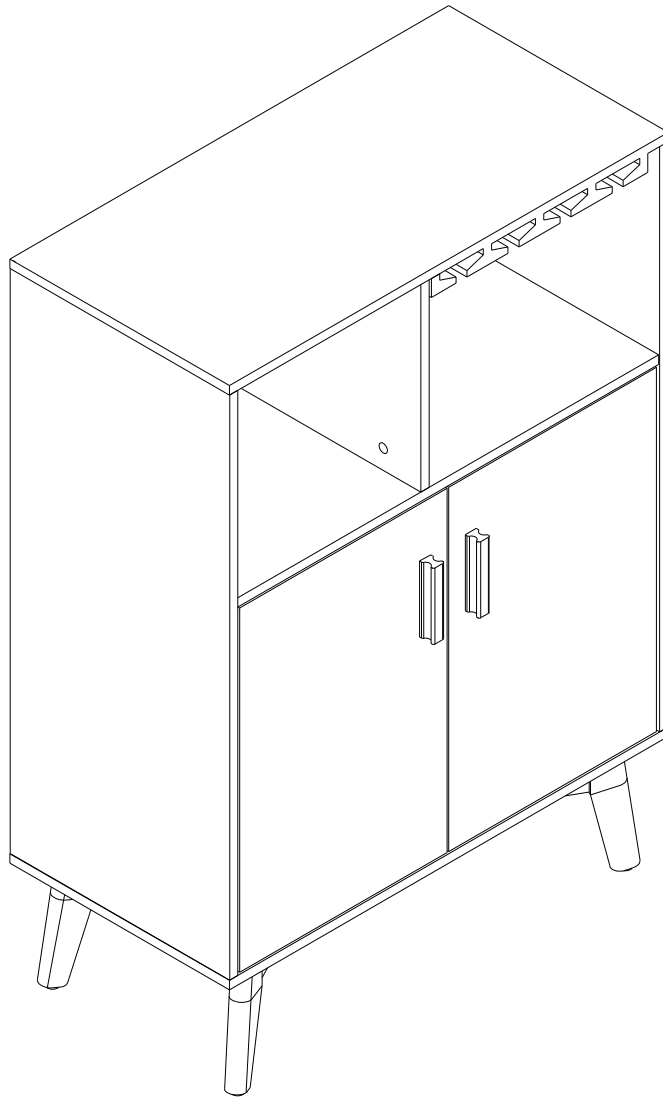

Notice:

1. Follow the installation instructions. Please confirm all accessories are preset before installation.
2. Do not fully tighten the screws during initial assembly. Fully tighten screws only once all pieces which are correctly assembled.
3. If you encounter any problems during installation, please contact our customer service.
4. Please unbox the item from the side with an open-label and put a carpet on the floor to avoid scratching it.

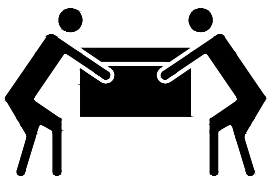

Recommended installers:2

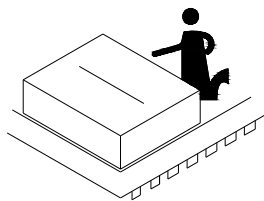

Put a carpet on the floor
before unpacking

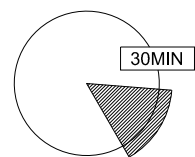

Estimate installation time:
30minutes





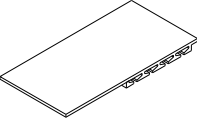
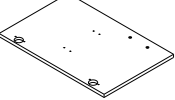
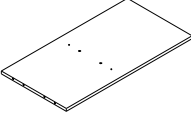
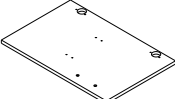
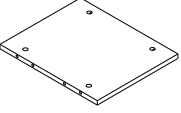
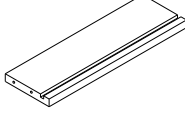
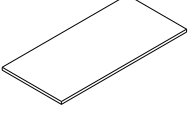
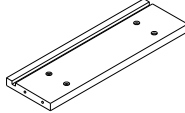
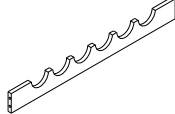
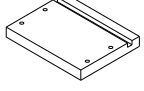
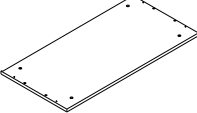
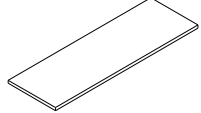
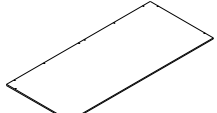
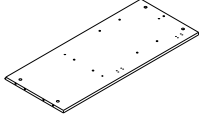
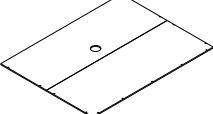
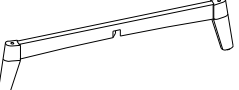
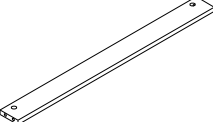
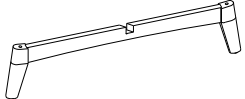

ASSEMBLY INSTRUCTIONS

PART LIST

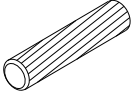
Item no.	Reference Image	Qty	Item no.	Reference Image	Qty
(A)		X1	(K)		X1
(B)		X1	(L)		X1
(C)		X1	(M)		X2
(D)		X1	(N)		X2
(E)		X1	(O)		X4
(F)		X1	(P)		X2
(G)		X1	(Q)		X1
(H)		X1	(R)		X1
(I)		X1	(T)		X1
(J)		X1			

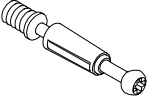
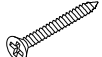
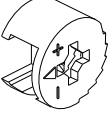
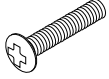
ASSEMBLY INSTRUCTIONS

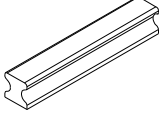
HARDWARE LIST

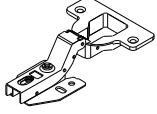
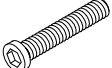
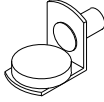
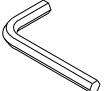
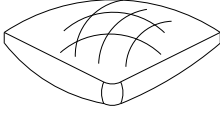
Item no.	Reference Image	Qty	Item no.	Reference Image	Qty
1	 Ø8*30mm	X20+2	8	 Ø7*Ø4*22mm	X8
2		X20+2	9	 Ø7*Ø4*30mm	X16+1
3		X20+2	10		X4
4	 Ø6.5*Ø3*15mm	X24+2	11		X2
5	 Ø6.5*Ø3*14mm	X24+2	12		X4
6	 Ø1/4*1-3/4"	X4	13		X4
7		X1	14		X1

ASSEMBLY INSTRUCTIONS

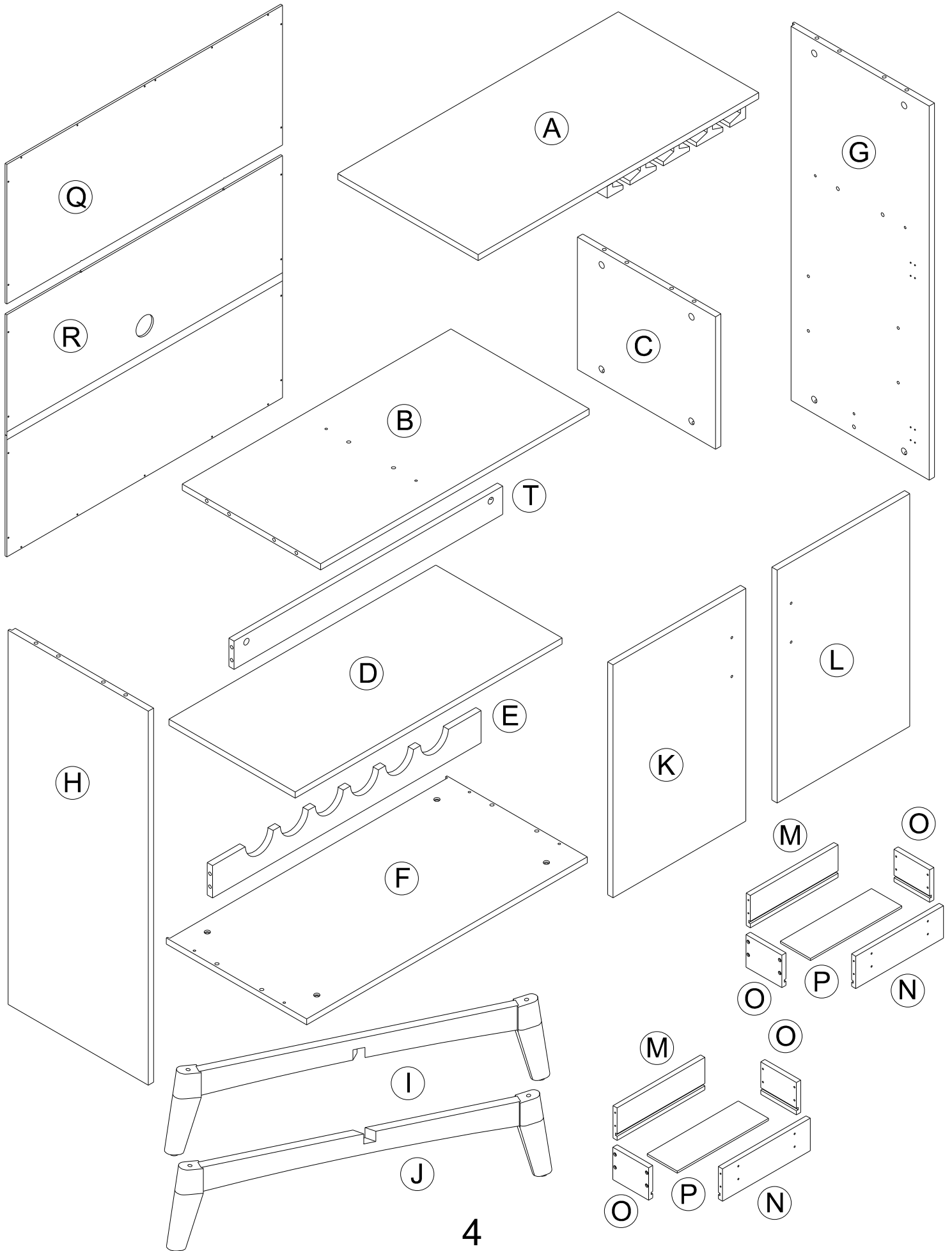

ASSEMBLY INSTRUCTIONS

1

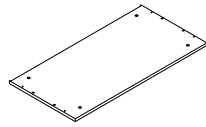

(B) 1pc

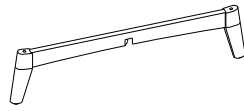

(I) 1pc

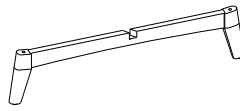

(J) 1pc

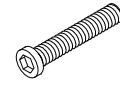

(6) 4pcs

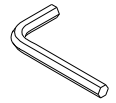

(7) 1pcs

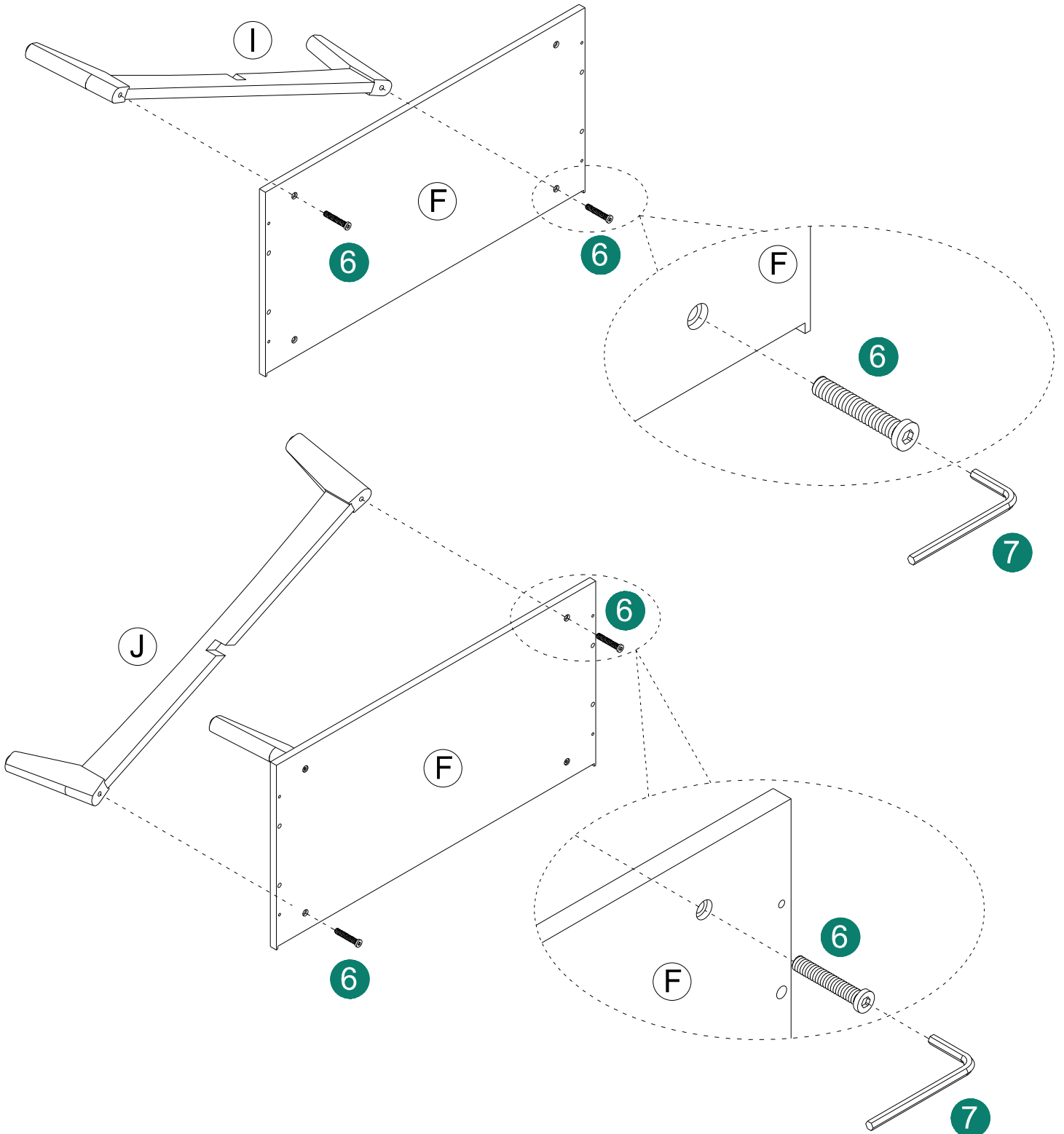

ASSEMBLY INSTRUCTIONS

2

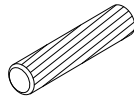

① 10pcs

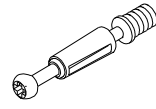

② 10pcs

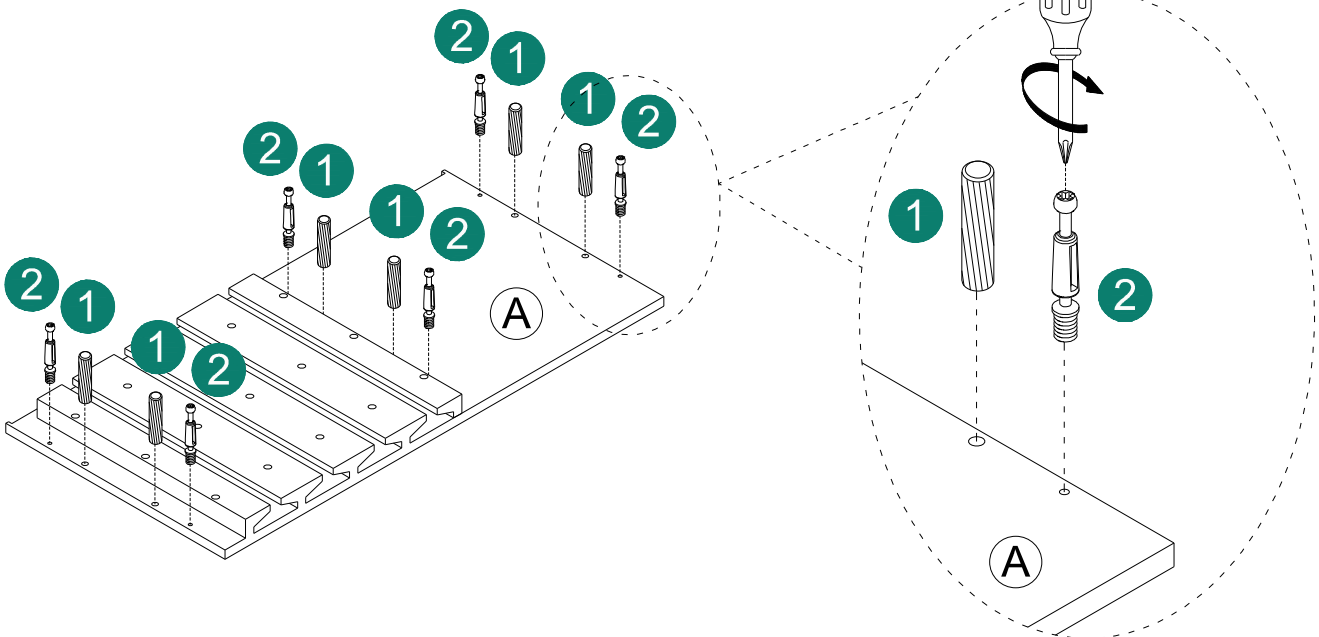
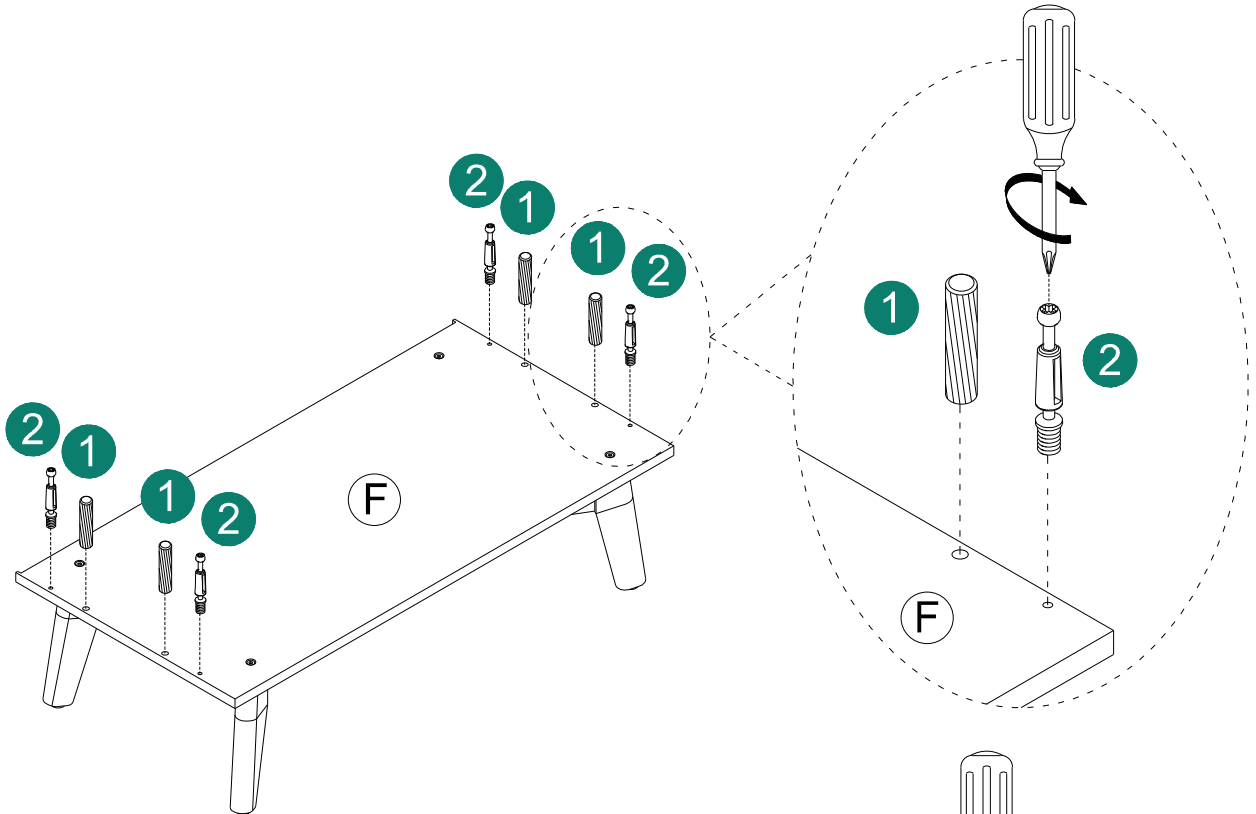

ASSEMBLY INSTRUCTIONS

3

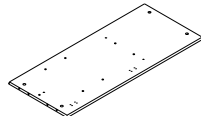

G 1pc

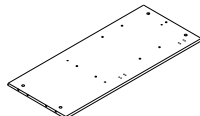

H 1pc

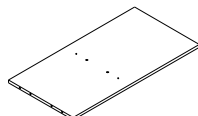

B 1pc

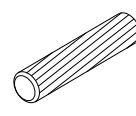

1 10pcs

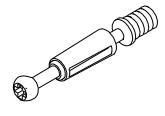

2 10pcs

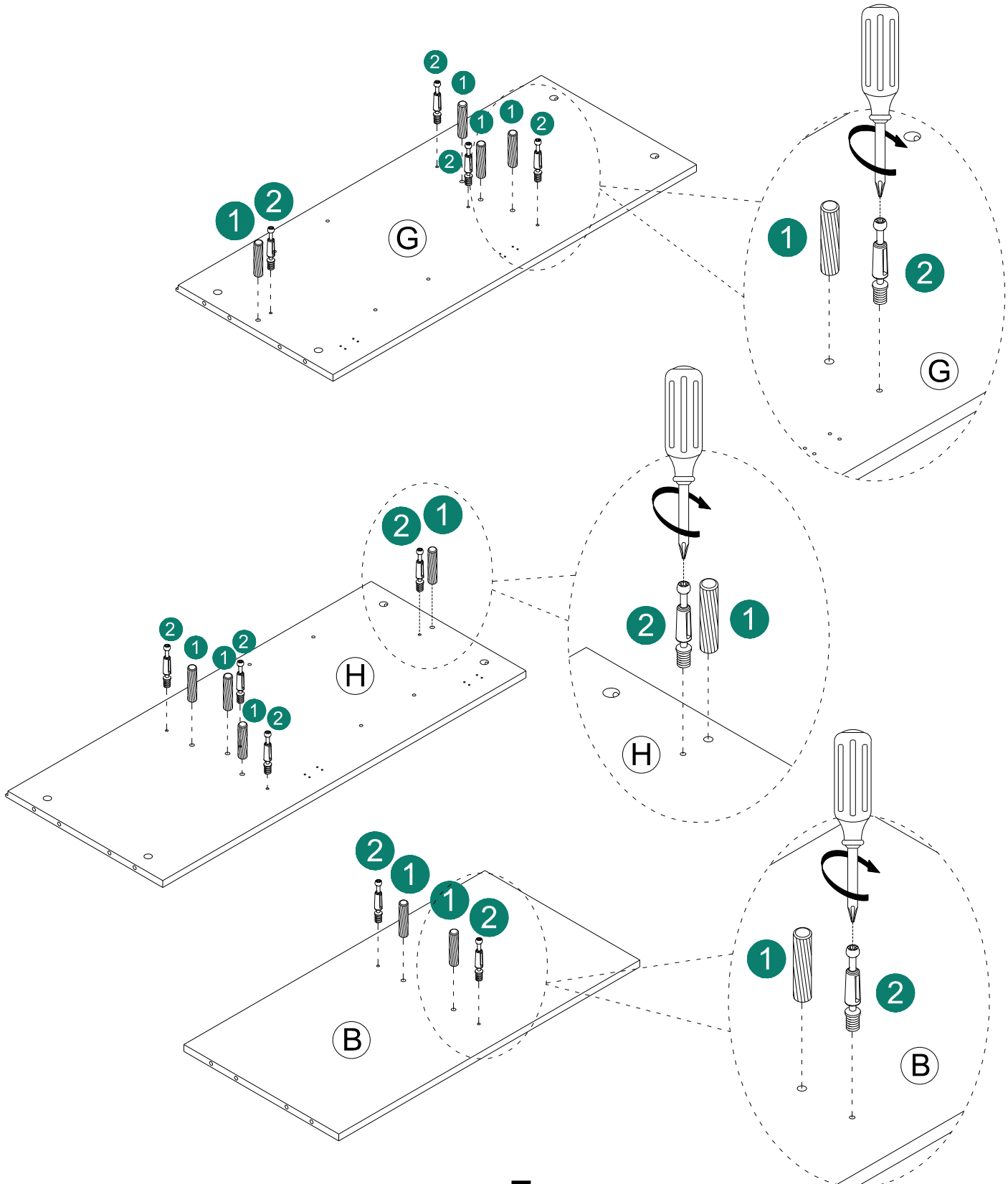

ASSEMBLY INSTRUCTIONS

4

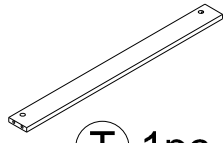

T 1pc

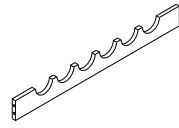

E 1pc

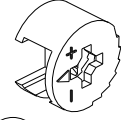

3 8pcs

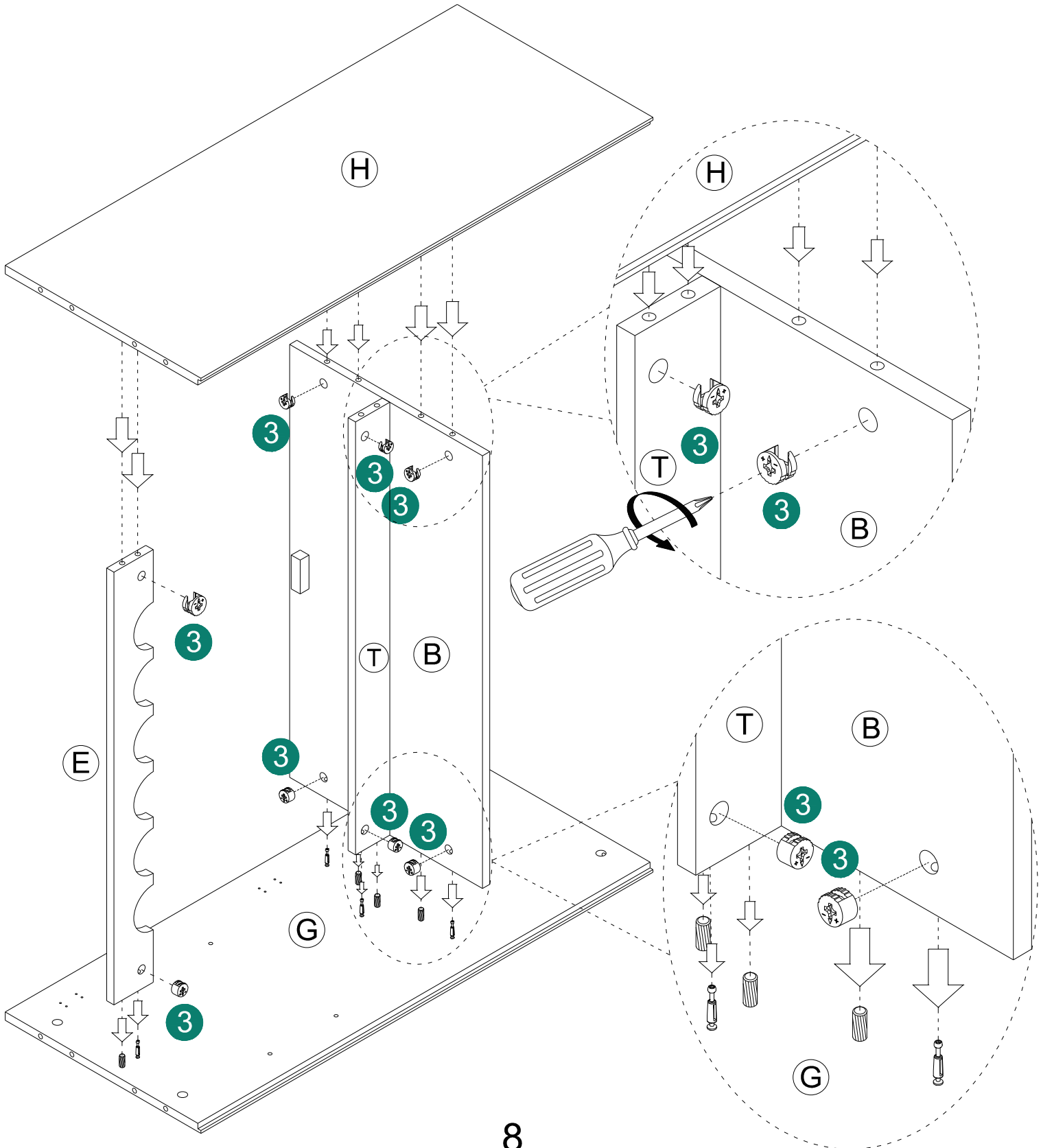

ASSEMBLY INSTRUCTIONS

5

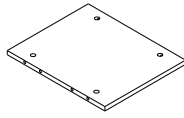

C 1pc

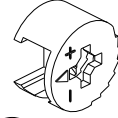

3 6pcs

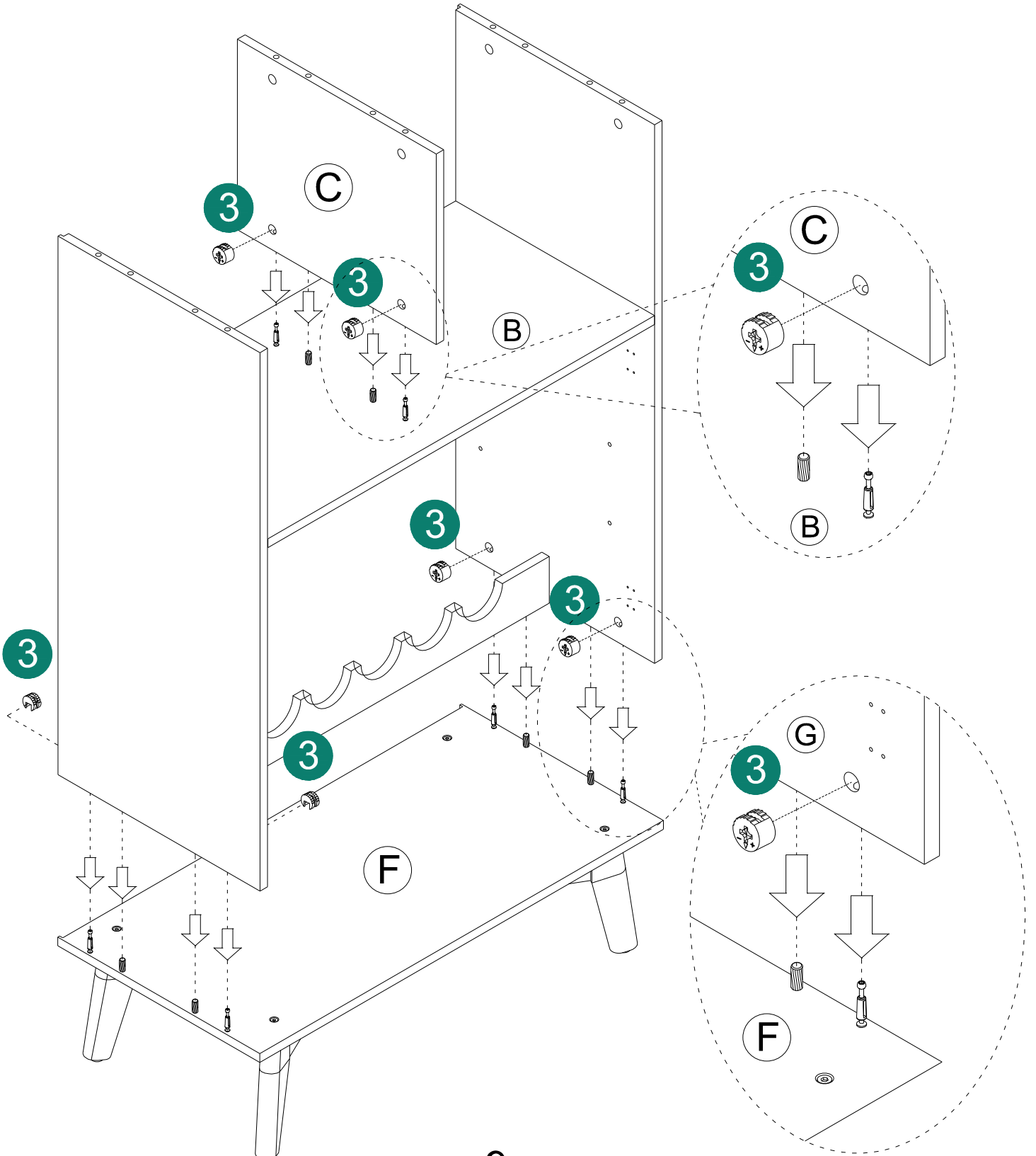

ASSEMBLY INSTRUCTIONS

6

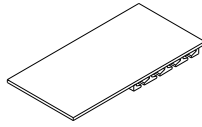

A 1pc

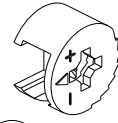

3 6pcs

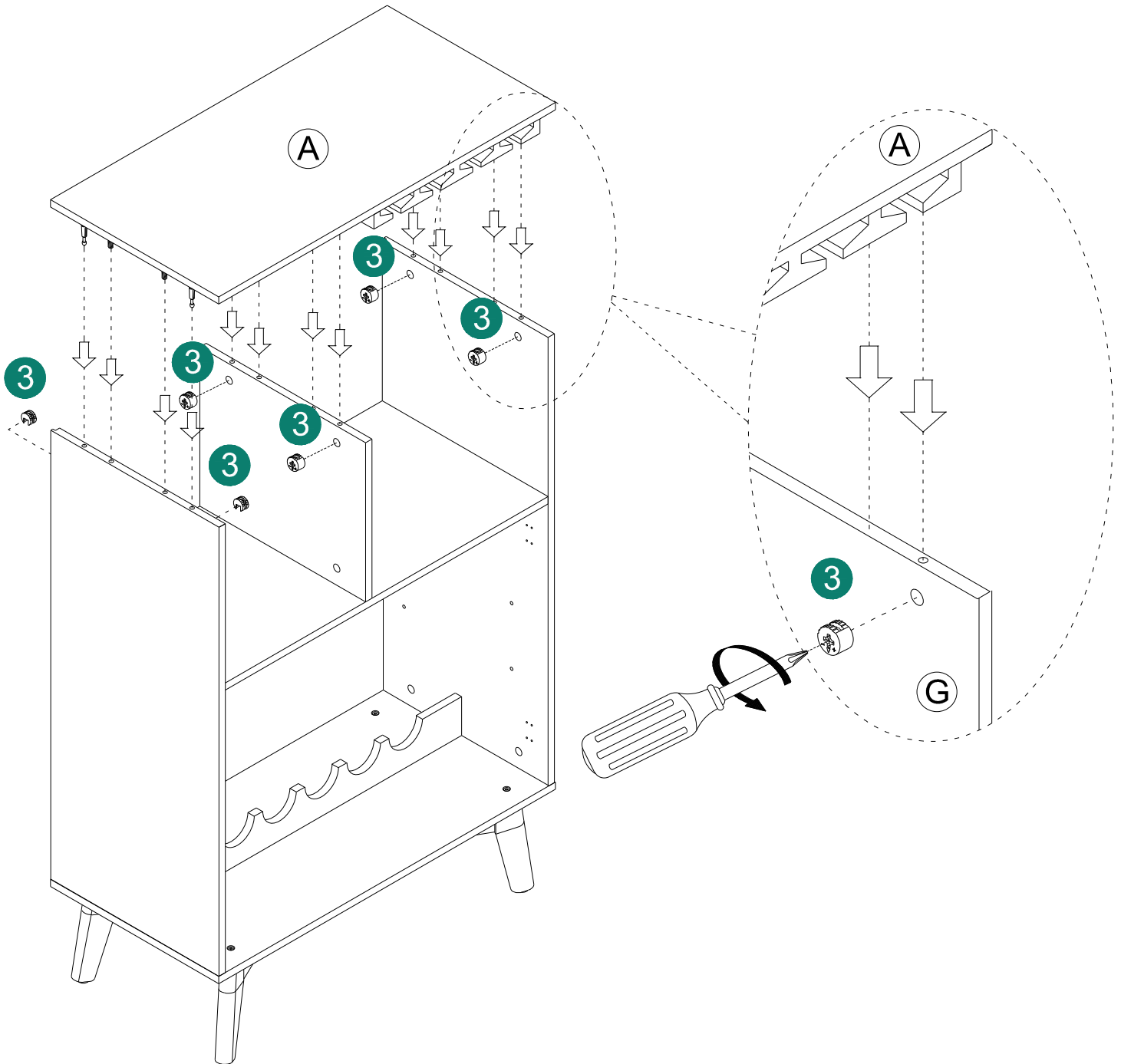

ASSEMBLY INSTRUCTIONS

8

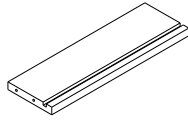

M 1pc

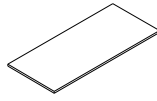

P 1pc



8 4pcs

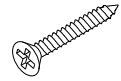

9 4pcs

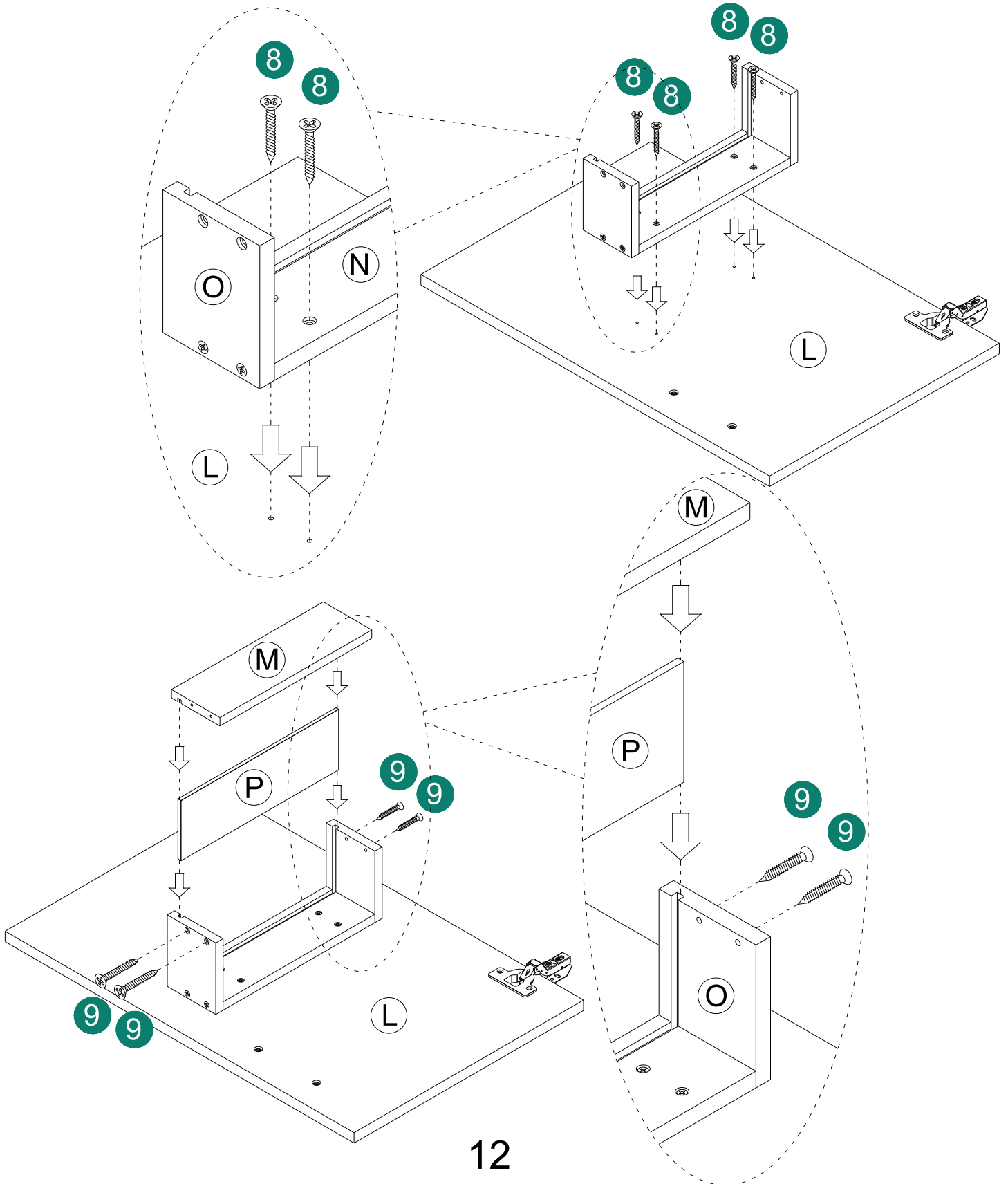

ASSEMBLY INSTRUCTIONS

9

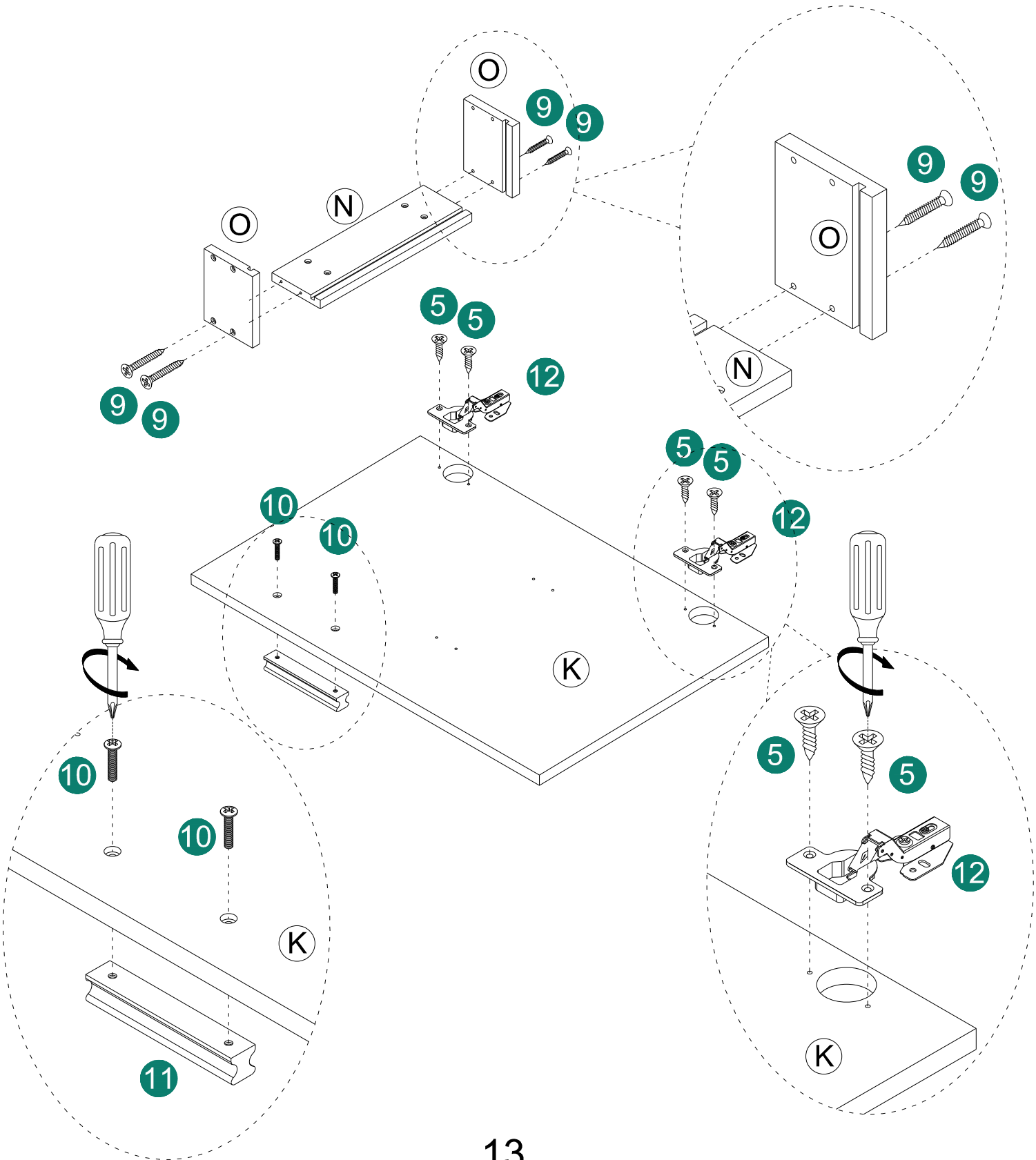
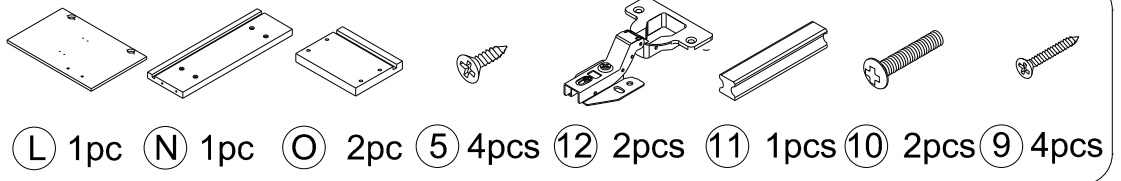

ASSEMBLY INSTRUCTIONS

10

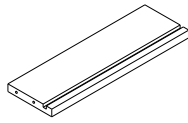

(M) 1pc

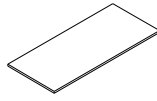

(P) 1pc



(8) 4pcs

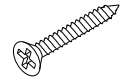

(9) 4pcs

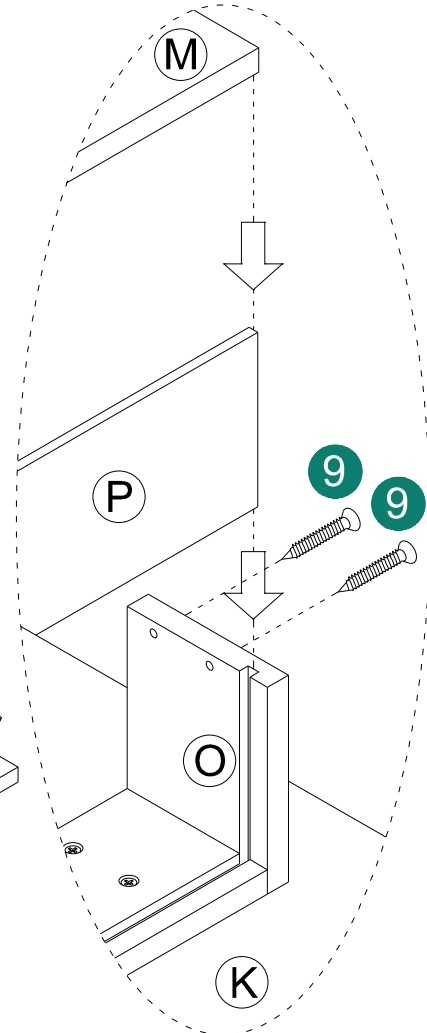
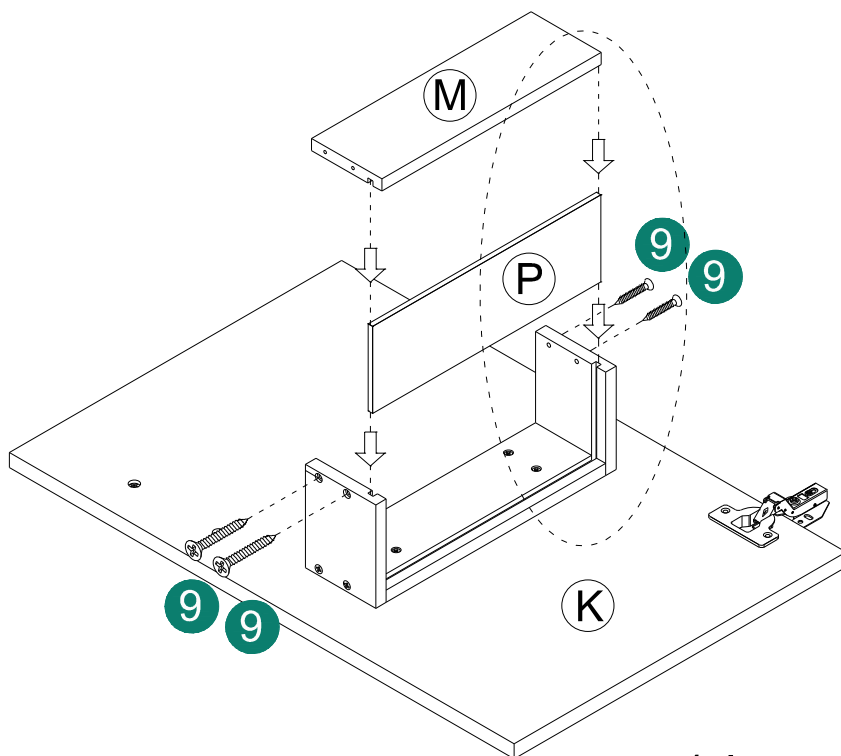
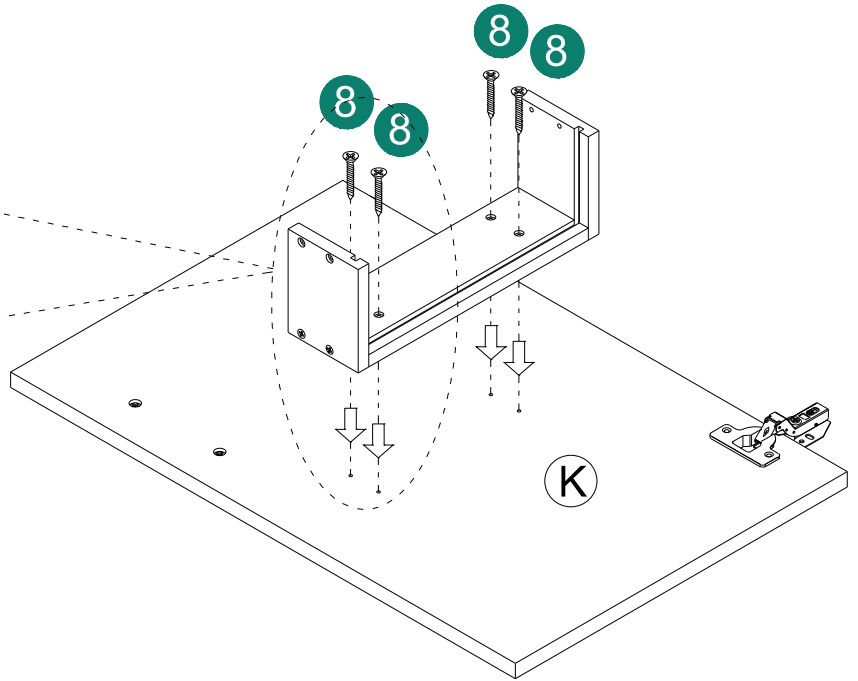
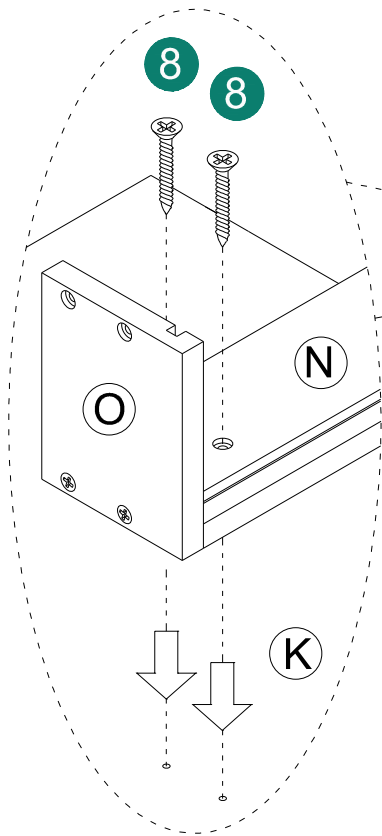

ASSEMBLY INSTRUCTIONS

11

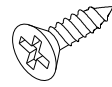

5 8pcs

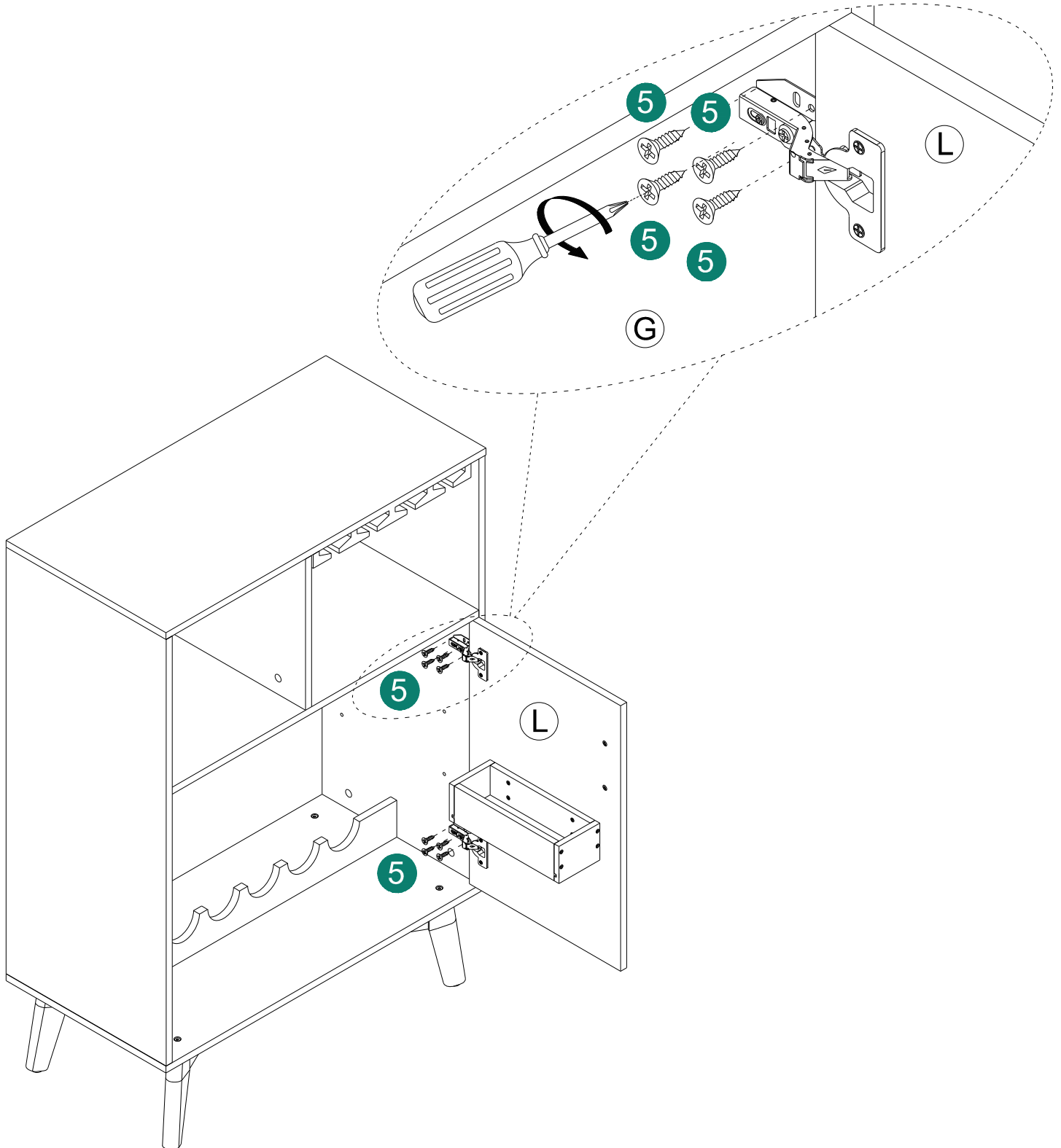

ASSEMBLY INSTRUCTIONS

12

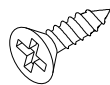

⑤ 8pcs

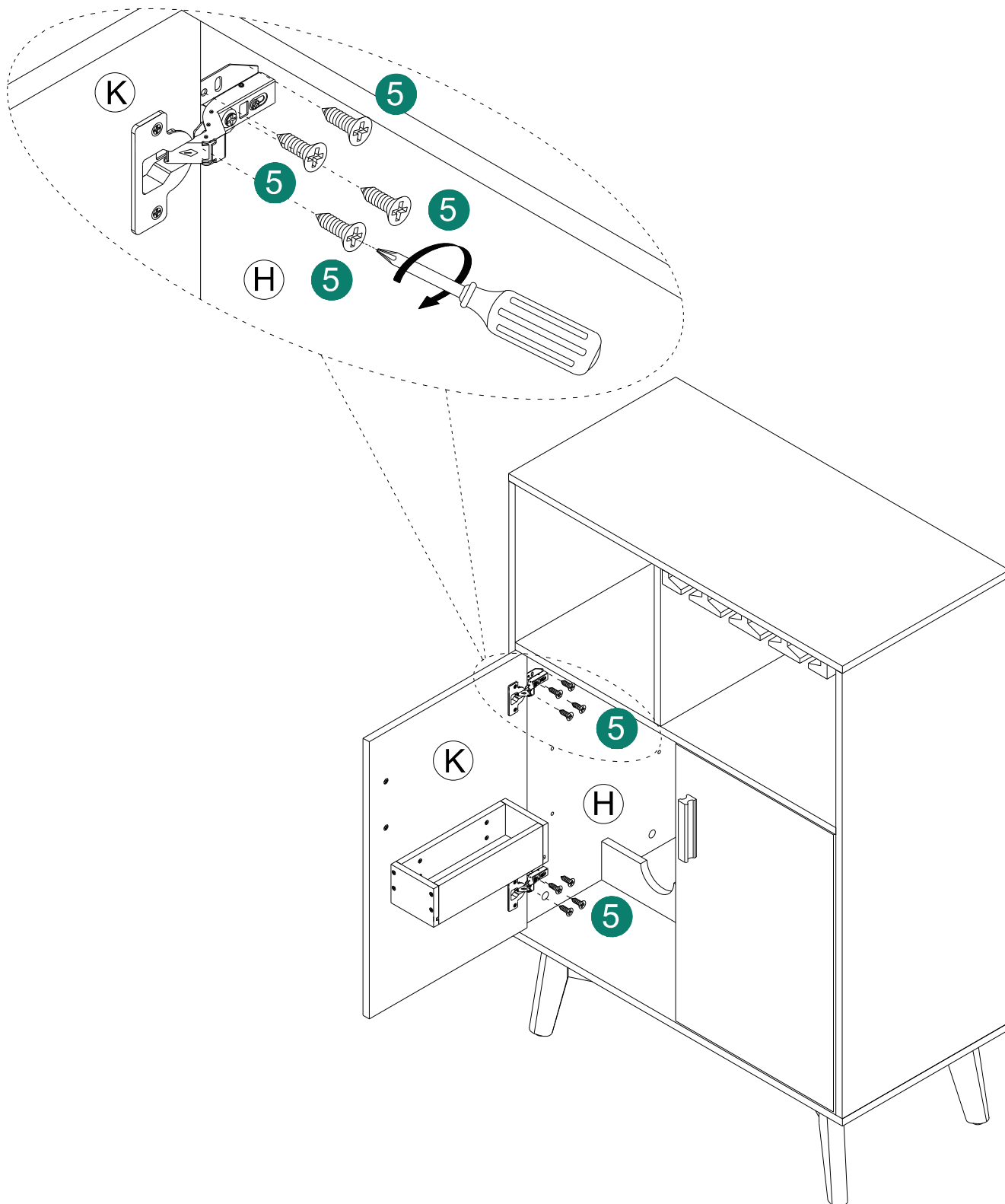

ASSEMBLY INSTRUCTIONS

13

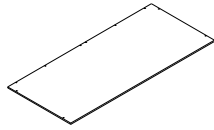

Q 1pc

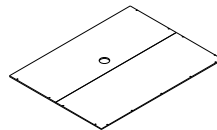

R 1pc

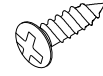

4 24pcs

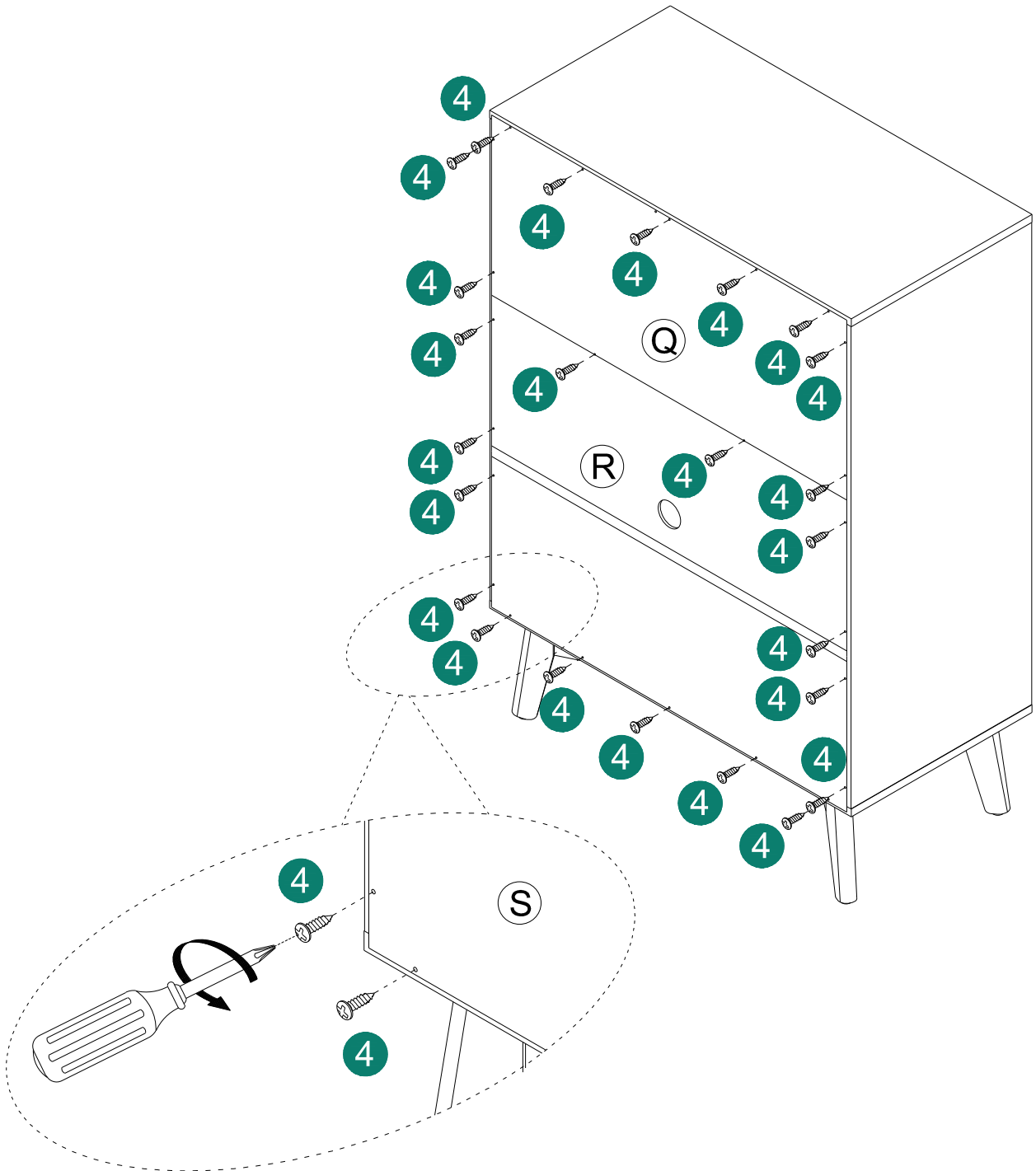

ASSEMBLY INSTRUCTIONS

14

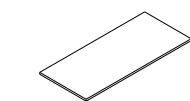

D 1pc



13 4pcs

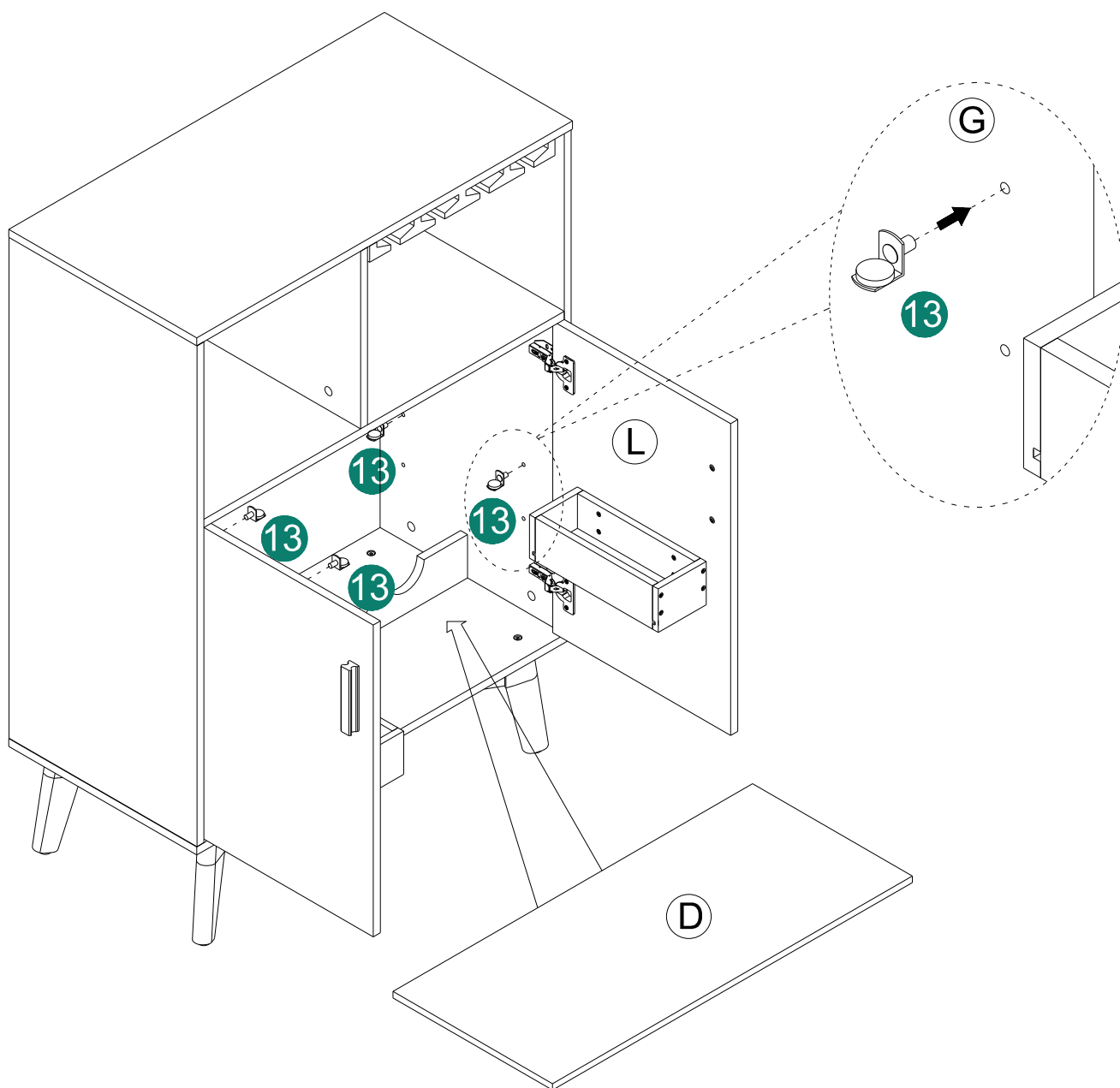

ASSEMBLY INSTRUCTIONS

15

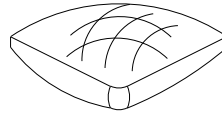

14 1set

A

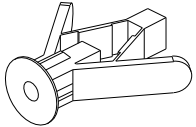

1pcs

B

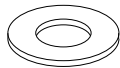

2pcs

C

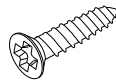

Ø8*3/4"

1pcs

D

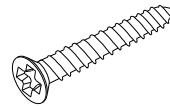

Ø8*1-1/2"

1pcs

E

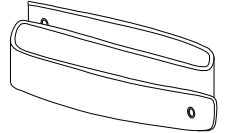

1pcs

WALL

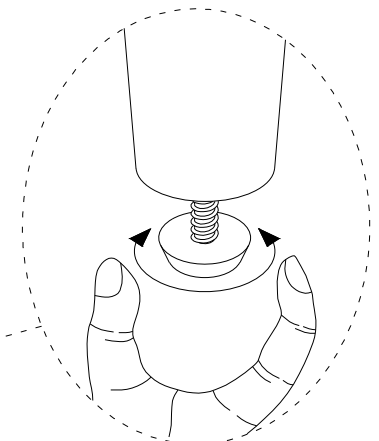
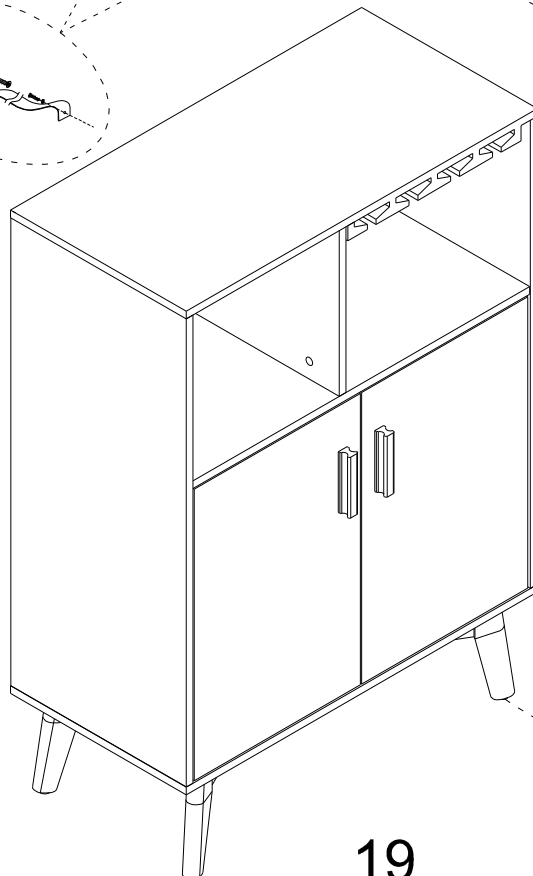
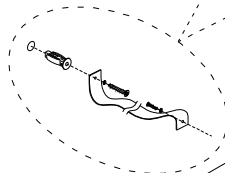
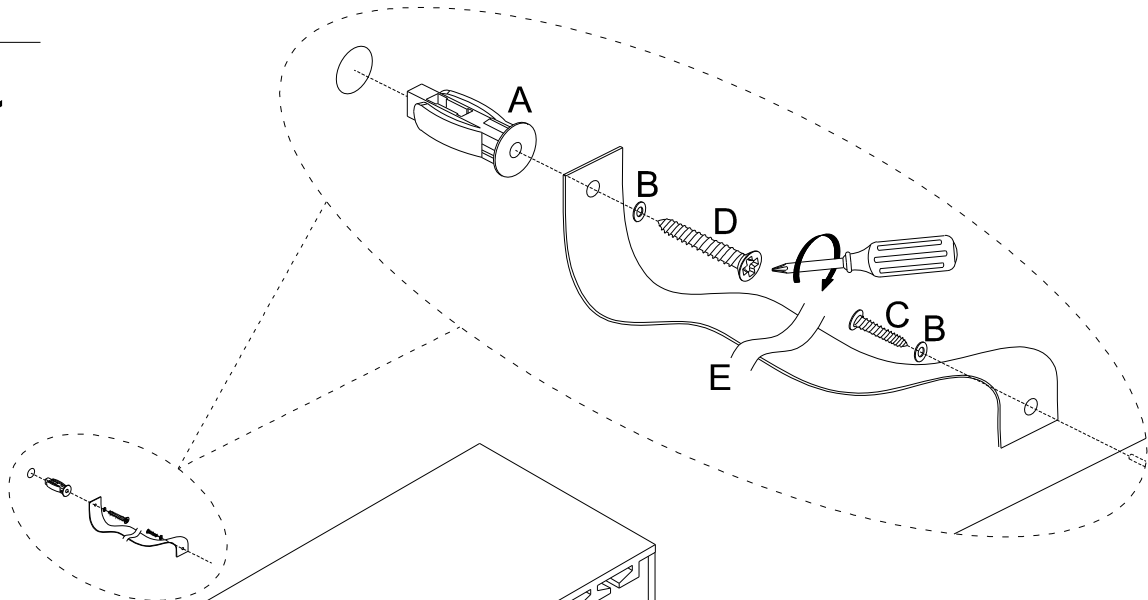

19