

Pull the kitchen pot faucet

Installation instruction

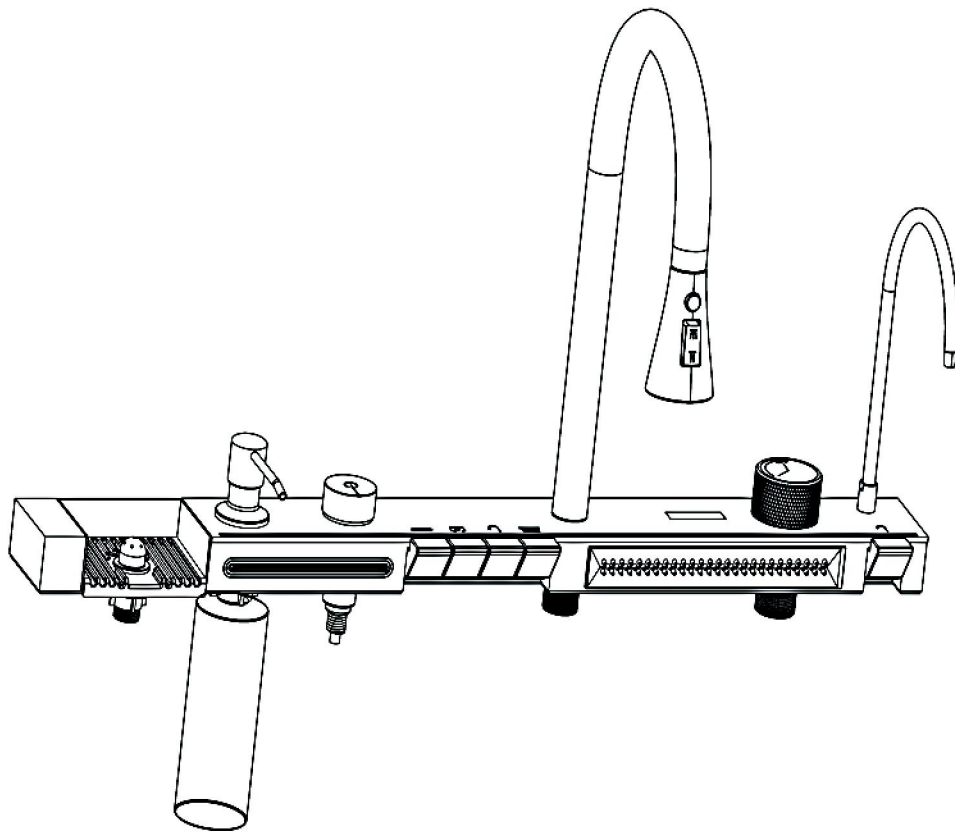

**Please specify the color number when ordering

Pull the kitchen pot faucet

Before installation

All information is based on the latest published product information. The Company reserves the right to change product features, packaging or types of products available at any time without notice. The instructions include important information on installation, maintenance and cleaning. Please give them to the user for reading.

Note:

1. Be sure to rinse the water supply pipe thoroughly first to remove impurities in the pipe
2. If you are installing a new wash basin, install the faucet on the wash basin first.
3. Shower working pressure :0.1MPa to 0.5MPa. When the water pressure exceeds 0.5mpa, a reducing valve must be installed. Maximum working temperature and ambient temperature of shower :60°C. Please make special note that the arm tube connected with the shower flush must be kept away from the heater, otherwise the shower and its seal may be damaged, or even harm the user.









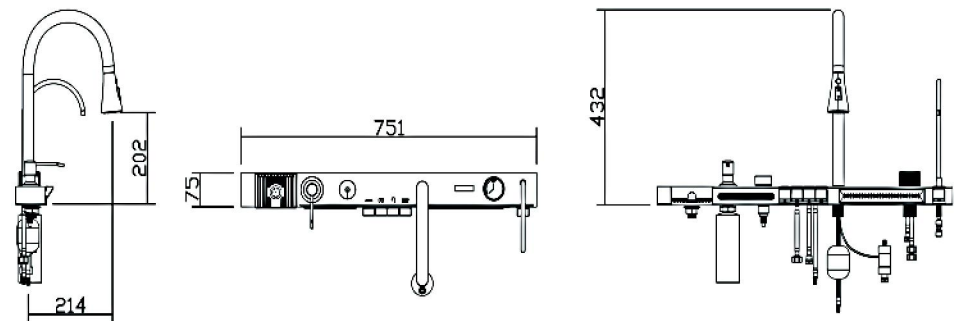

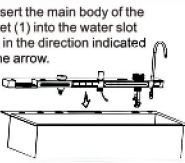
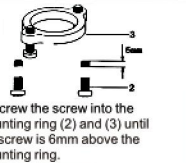
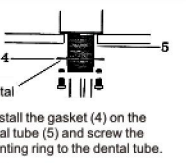
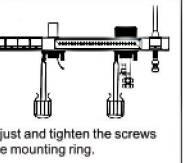
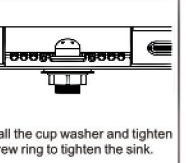
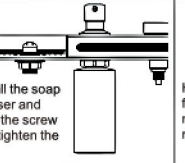



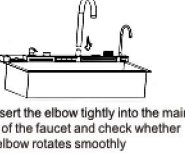
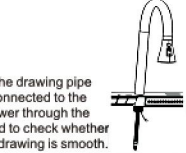
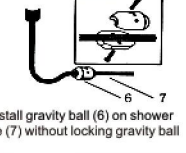

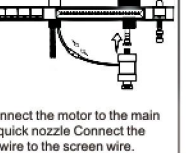
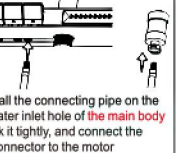

Instructions for use

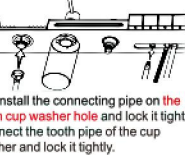
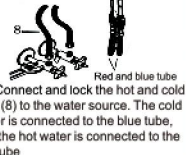
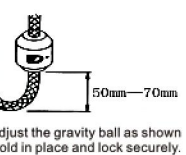
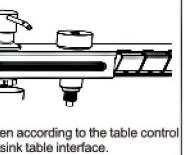
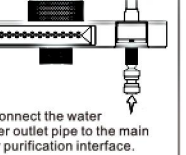



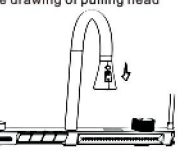



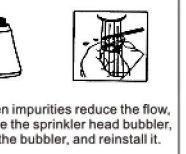

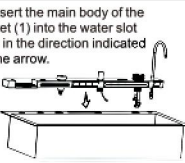
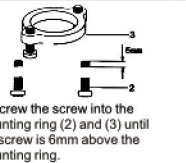
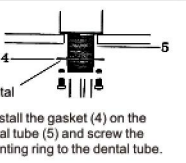
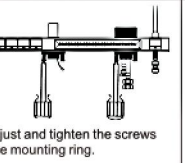
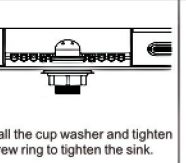
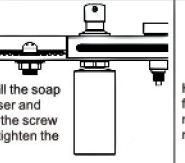



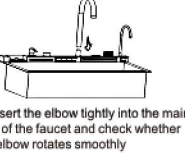
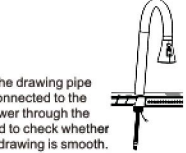
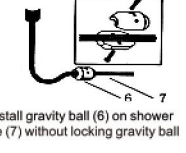

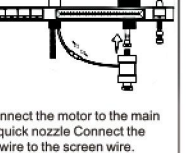
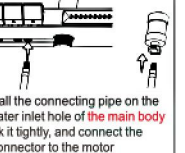

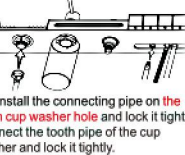
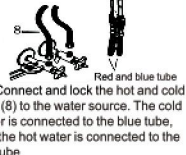
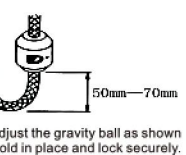
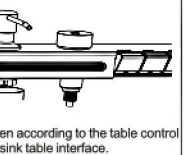
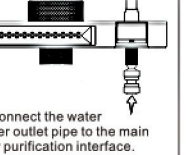

Hand wheel switch, turn fixed temperature cold water - mixed water - hot water to the left: turn right to close the water main switch. The left button controls the water mode.

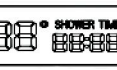
*Hand wheel is the main switch, anti-green pressure (2.5MPa) must be closed every time after use, if there is not known to cause loss, the company will not be responsible.

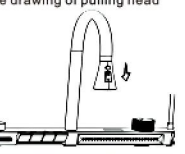
Mounting dimension

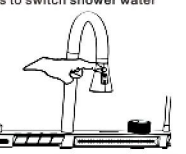

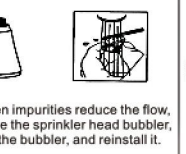
Installation procedure						Use guideline			
1. Insert the main body of the faucet (1) into the water slot hole in the direction indicated by the arrow.							 Hand wheel switch, turn to the left for constant temperature cold water-mixed water - hot water; turn to the right to close the water main switch. (Always turn it off after each use)	 Rain water key Cannot be used as main switch	 Pull head water button Cannot be used as main switch
2. Screw the screw into the mounting ring (2) and (3) until the screw is 6mm above the mounting ring.									
3. Install the gasket (4) on the dental tube (5) and screw the mounting ring to the dental tube.									
4. Adjust and tighten the screws for the mounting ring.									
5. Install the cup washer and tighten the screw ring to tighten the sink.									
6. Install the soap dispenser and tighten the screw ring to tighten the sink.									
7. Insert the elbow tightly into the main joint of the faucet and check whether the elbow rotates smoothly.							 Cup washer water button Cannot be used as main switch	 Waterfall water key Cannot be used as main switch	 Clean water outlet button Cannot be used as main switch
8. The drawing pipe is connected to the shower through the bend to check whether the drawing is smooth.									
9. Install gravity ball (6) on shower hose (7) without locking gravity ball first.									
10. Connect shower hose to shower hole of main body.									
11. Connect the motor to the main spool quick nozzle. Connect the motor wire to the screen wire.									
12. Install the connecting pipe on the main water inlet hole of the main body and lock it tightly, and connect the quick connector to the motor.									
13. Install the connecting pipe on the main cup washer hole and lock it tightly. Connect the tooth pipe of the cup washer and lock it tightly.							 The digital screen displays the water temperature/effluent time.	 Console switch knob	 Soap dispenser press key
14. Connect and lock the hot and cold pipe (8) to the water source. The cold water is connected to the blue tube, and the hot water is connected to the red tube.									
15. Adjust the gravity ball as shown. Hold in place and lock securely.									
16. Even according to the table control light sink table interface.									
17. Connect the water purifier outlet pipe to the main water purification interface.									
18. Turn on hot and cold water and tap switch, let water flow out for about two minutes.									
Free drawing of pulling head						Installation completion check Check and ensure that all joints are tight and hand wheel is in closed position. Turn on the main water and drainage systems, check and repair leaky interfaces.			
Press to switch shower water				Faucet maintenance: 1. Turn on the faucet and rub the nozzle to clean up impurities.	2. When impurities reduce the flow, remove the sprinkler head bubbler, clean the bubbler, and reinstall it.	Cleaning instruction Not for all processed surfaces: Wash the coated surface with neutral soapy water and dry the entire surface thoroughly with a clean soft cloth. Many cleaners such as ammonia, detergent powder, toilet cleaner, etc., will cause damage to the coating surface, should not be used. Wear cleaning appliances or cleaners should not be used on faucets and accessories.			

Installation procedure						Use guideline			
1. Insert the main body of the faucet (1) into the water slot hole in the direction indicated by the arrow.							 Hand wheel switch, turn to the left for constant temperature cold water-mixed water - hot water; turn to the right to close the water main switch. (Always turn it off after each use)	 Rain water key Cannot be used as main switch	 Pull head water button Cannot be used as main switch
2. Screw the screw into the mounting ring (2) and (3) until the screw is 6mm above the mounting ring.									
3. Install the gasket (4) on the dental tube (5) and screw the mounting ring to the dental tube.									
4. Adjust and tighten the screws for the mounting ring.									
5. Install the cup washer and tighten the screw ring to tighten the sink.									
6. Install the soap dispenser and tighten the screw ring to tighten the sink.									
7. Insert the elbow tightly into the main joint of the faucet and check whether the elbow rotates smoothly.							 Cup washer water button Cannot be used as main switch	 Waterfall water key Cannot be used as main switch	 Clean water outlet button Cannot be used as main switch
8. The drawing pipe is connected to the shower through the bend to check whether the drawing is smooth.									
9. Install gravity ball (6) on shower hose (7) without locking gravity ball first.									
10. Connect shower hose to shower hole of main body.									
11. Connect the motor to the main spool quick nozzle. Connect the motor wire to the screen wire.									
12. Install the connecting pipe on the main water inlet hole of the main body and lock it tightly, and connect the quick connector to the motor.									
13. Install the connecting pipe on the main cup washer hole and lock it tightly. Connect the tooth pipe of the cup washer and lock it tightly.							 The digital screen displays the water temperature/effluent time.	 Console switch knob	 Soap dispenser press key
14. Connect and lock the hot and cold pipe (8) to the water source. The cold water is connected to the blue tube, and the hot water is connected to the red tube.									
15. Adjust the gravity ball as shown. Hold in place and lock securely.									
16. Even according to the table control light sink table interface.									
17. Connect the water purifier outlet pipe to the main water purification interface.									
18. Turn on hot and cold water and tap switch, let water flow out for about two minutes.									
Free drawing of pulling head							Installation completion check Check and ensure that all joints are tight and hand wheel is in closed position. Turn on the main water and drainage systems, check and repair leaky interfaces.		
Press to switch shower water				Faucet maintenance: 1. Turn on the faucet and rub the nozzle to clean up impurities.	2. When impurities reduce the flow, remove the sprinkler head bubbler, clean the bubbler, and reinstall it.	Cup washer Silicone pad removable for cleaning	Cleaning instruction Not for all processed surfaces: Wash the coated surface with neutral soapy water and dry the entire surface thoroughly with a clean soft cloth. Many cleaners such as ammonia, detergent powder, toilet cleaner, etc., will cause damage to the coating surface, should not be used. Wear cleaning appliances or cleaners should not be used on faucets and accessories.		