

# ASSEMBLY INSTRUCTION

**N723P228103**

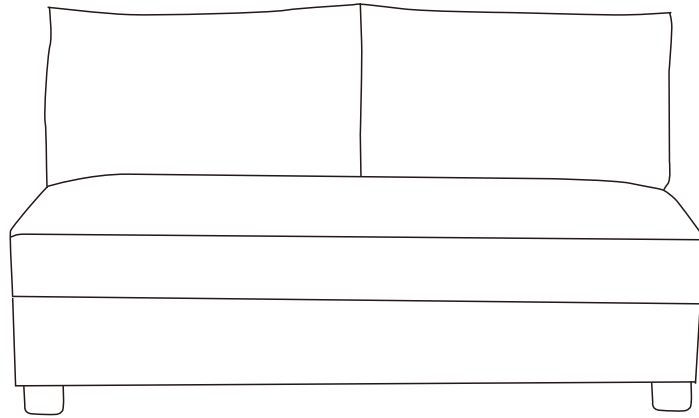

Sets often ship in multiple boxes and delivery date may vary.

## CUSTOMER SERVICE

**Questions, Missing parts, Assembly help?  
No need to return the product, we will gladly help and ship  
your replacement parts free of charge.**

# PRE-ASSEMBLY INFORMATION

**Please read this manual carefully before beginning assembly of this product. Keep this manual for future reference.**

## NOTICE

1. Please assemble it AFTER all boxes are received.
2. Please do not throw away any of the packages or the instruction until the sofa is fully assembled.
3. Please keep children away from the plastic bags or any small pieces of stuff.
4. Some key parts of our product may be stored and hidden inside of other parts. Please open any zippered or hook & loop storage compartments to take out all parts.
5. Please do not open the compressed packages until your sofa frame is completely assembled.
6. As the cushions are all vacuum compressed, there will be some wrinkles. Please give them up to 72 hours to reach its original size and the wrinkles will basically disappear.
7. DO NOT INSTALL THE SCREWS ALL THE WAY IN THE BEGINNING. Place each screw into their proper hole and use your hand to twist the screw halfway. Twist all the screws in halfway to ensure the holes will match up properly and the product is level on the ground. When everything seems fitted, then tighten the screws.
8. Do not over tighten screws and bolts to avoid stripping.



2 adults recommended



Takes about 1.5 Hours to assemble



Weight capacity of each seat: 330LBS

---

# COMPONENTS

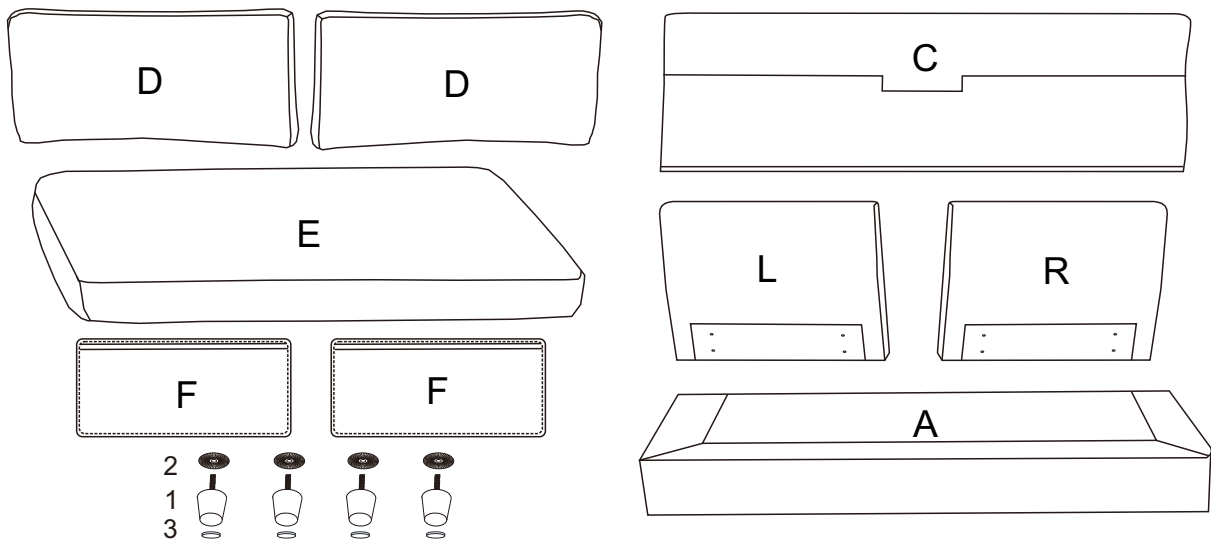

## HARDWARE

NO	DESCRIPTION	SKETCH	QTY
4	Screws 8x40		8
5	Washer		16
6	Hex Key		1
7	Screws 8x70		4
8	Screws nut		4
9	Spanner		1

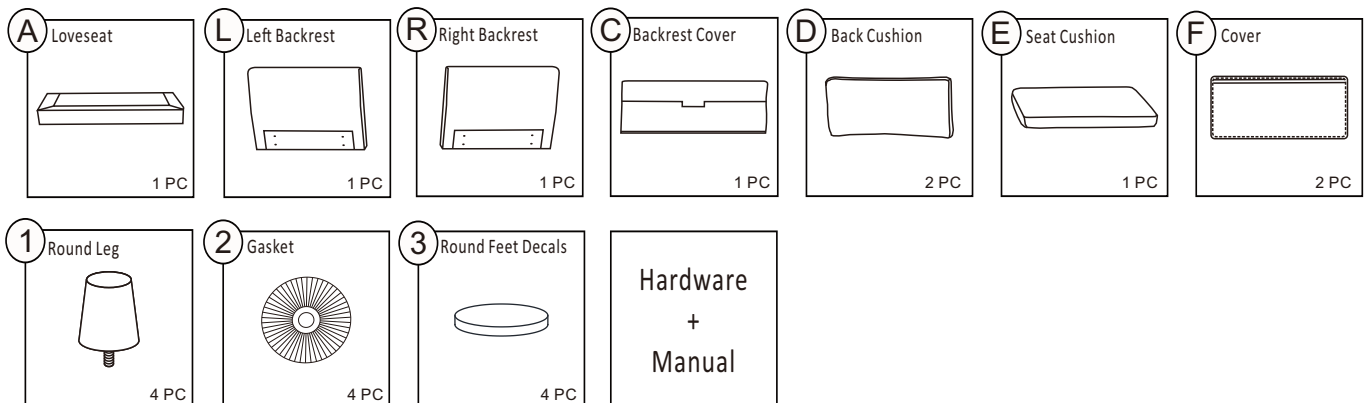

N723P228103



# ASSEMBLY STEPS

## STEP 1

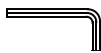

Connect seat frame (A) to the backrests (L&R) with screws(4) and washers(5) by hex key(6).

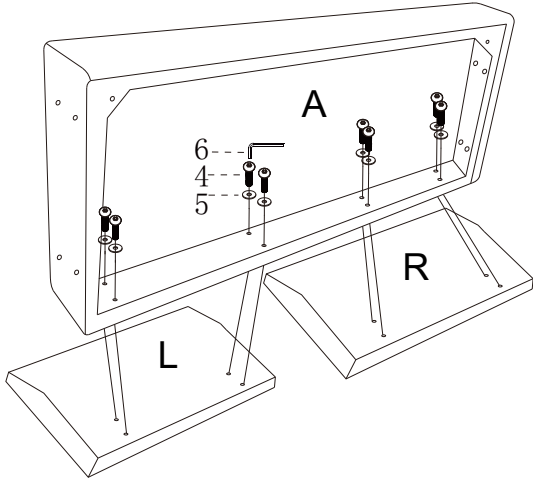
4		8
5		8
6		1



## STEP 2

Put the cover (C) on the backrest.  
Attach covers (F) to the both side of seat frame.  
Attach legs(1) and gaskets (2) to the seat frame.  
Stick the feet decals (3) onto each leg.

1		4
2		4
3		4

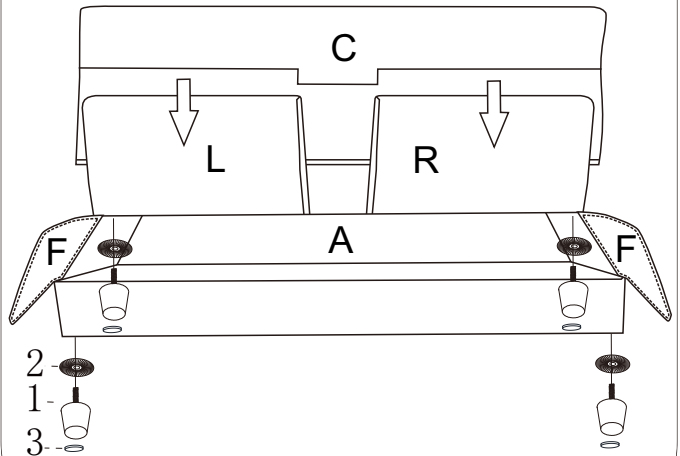

## STEP 3

Open the vacuum bag and take the cushions (D&E) out.  
To restore the original shape, follow the steps below.

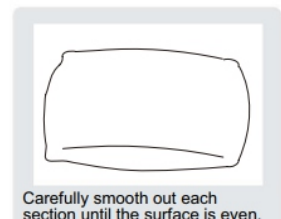
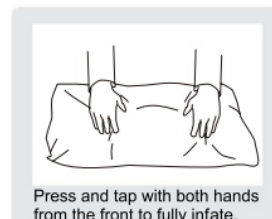
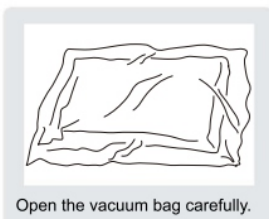

After packing up, place them in somewhere dry and venslated. After about 72-96 hours. It can be restored to the best use condition.

## STEP 4

Put the cushions (D&E) on the sofa.

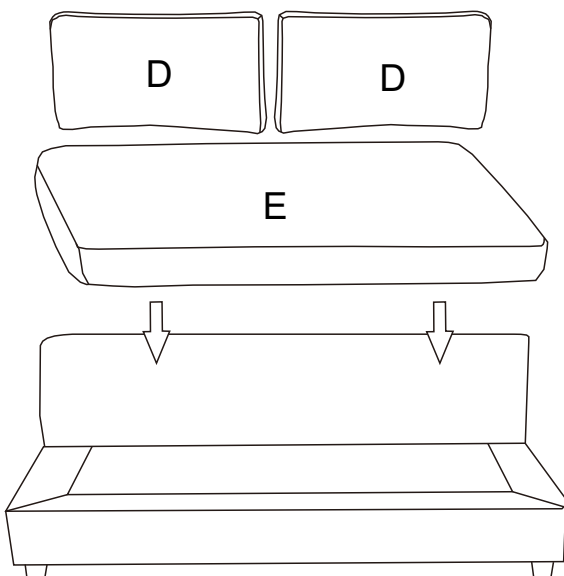

## STEP 5

Complete

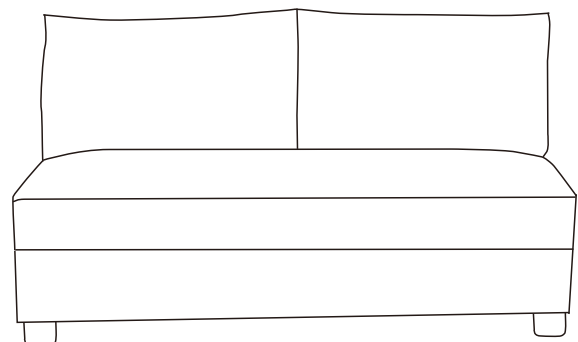

# ASSEMBLY STEPS

## STEP 6

Connect seat frame (A) to the other part with screws(7), washers(5) and screws nut (8) by hex key(6) and spanner (9).

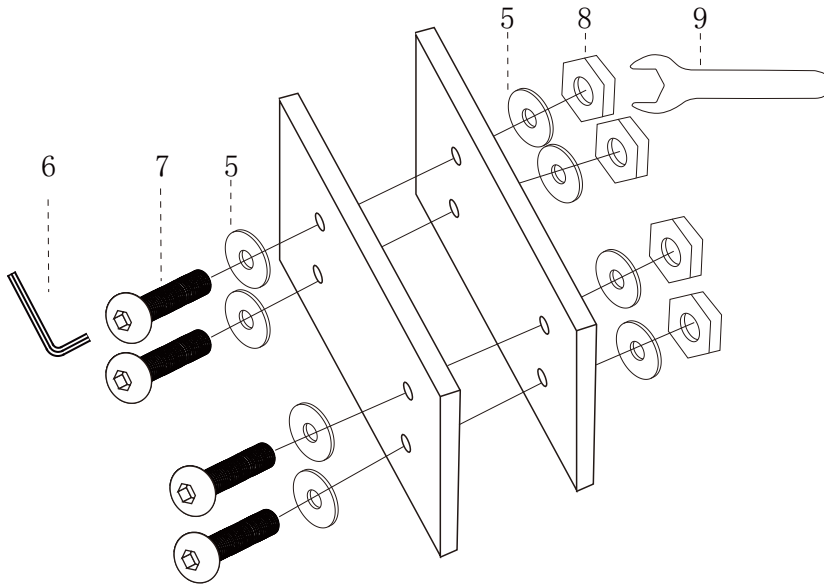

5		8
6		1
7		4
8		4
9		1

## Multiple combinations



