

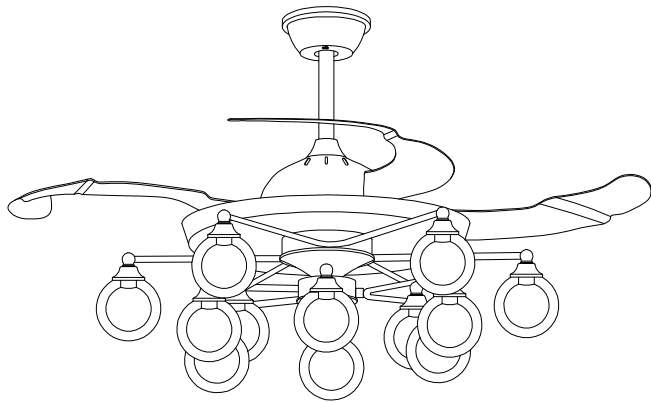

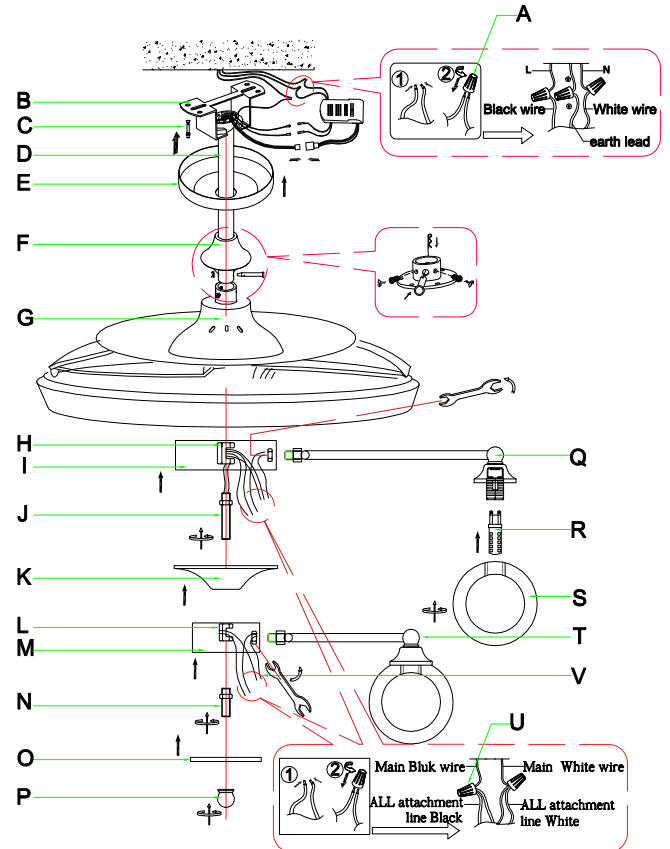











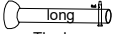











Product Instruction



G9*12xMAX.40W G9*16xMAX.40W
110-265V
Material: Metal+Glass
Color: Black/Golden



Part list:

A  x3	B  x1	C  x2	D   x1 The long pole and the short pole can be selected according to the height of the scene	
E  x1	F  x1	G  x1	H  big x1	I  big x1
J  long x1	K  x1	L  small x1	M  small x1	N  short x1
O  x1	P  x1	Q  3 or 4	R  Bulb 12 or 16	S  12 or 16
T  3 or 4	U  big x4	V  Black wire  White wire x1	W  x1	X  x1

You will need:



Installation Steps:

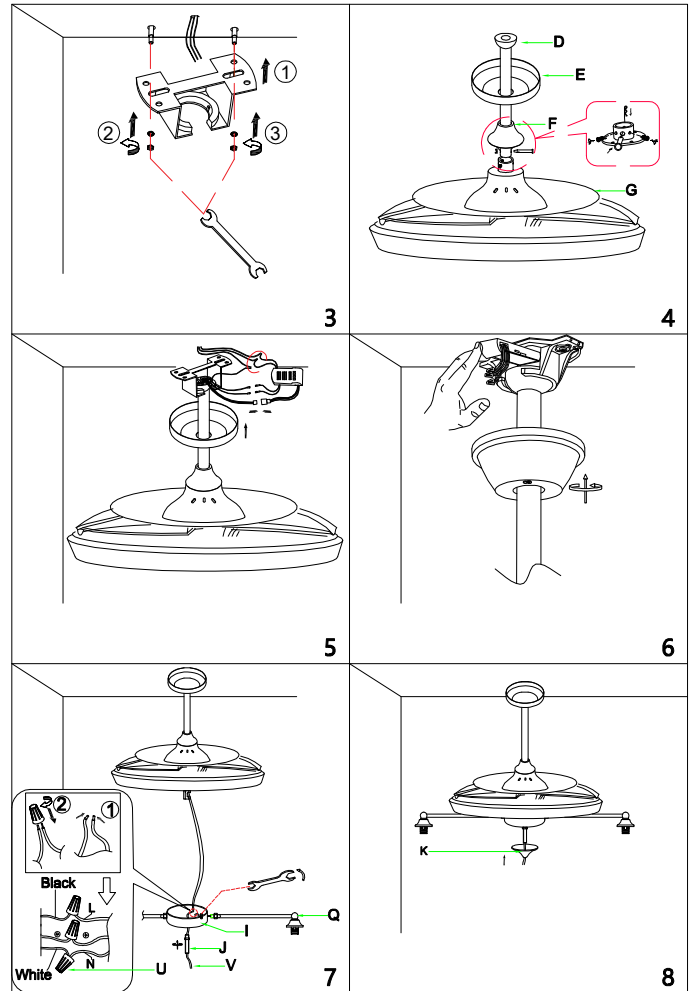
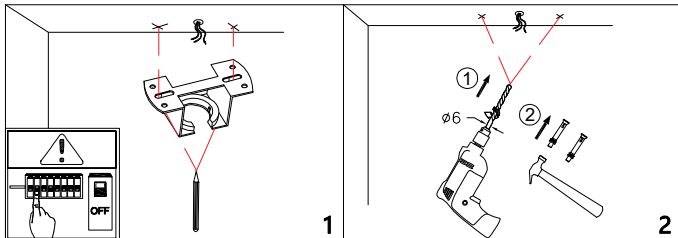

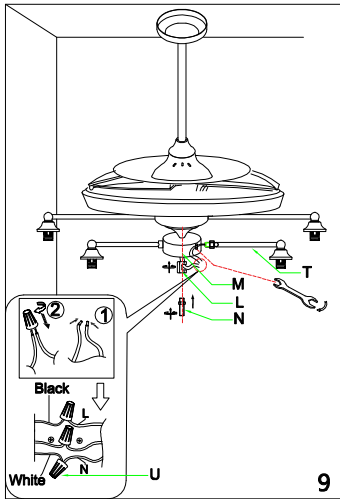

9

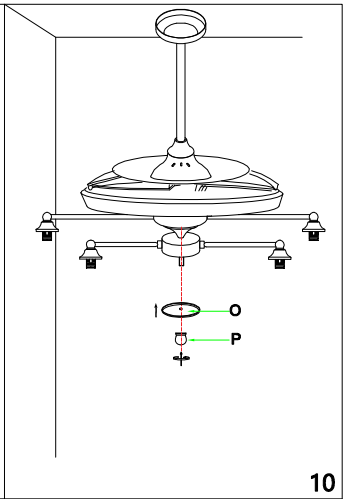

10

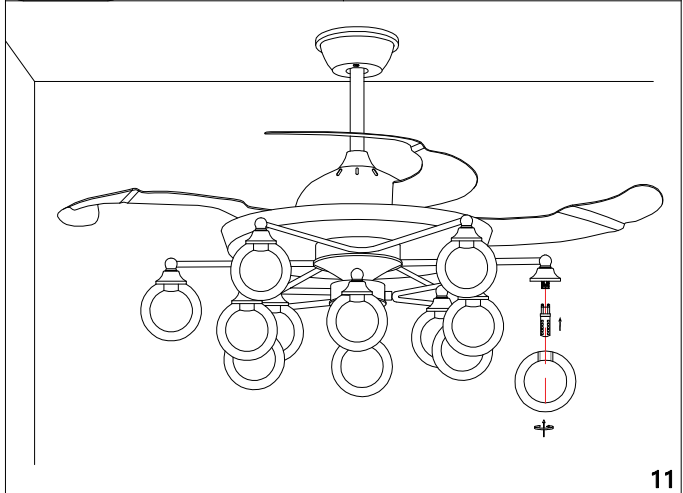

11

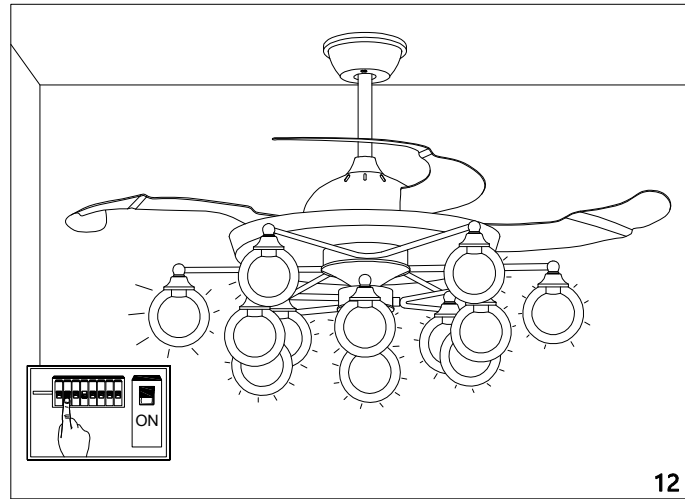

12

Note:**English**

1. The lamps may only be installed by authorized and qualified technicians according to the valid regulations for electrical installation.
2. The manufacturer does not accept any responsibility for injuries or damage resulting from improper use of the light.
3. Attention! Before starting the installation work, make sure that the mains power line is voltage-free-turn off safety cutout or unscrew the protection fuse. The switch must be "OFF".
4. Warning! Before drilling the mounting holes, make sure that no gas, water or electricity pipes and wires can be drilled through or damaged in your chosen mounting location.
5. Description of the supply terminals: L=Phase N= Neutral conductor  = Earthed conductor.