







# Assembly Instruction

## Parts List:

REF	PART NAME	PART IMAGE	QTY	REF	PART NAME	PART IMAGE	QTY	
A	Backrest		2	E	STEEL WASHER M6		8	+1PCS
B	Base		2	F	BOLT (M6*40)		8	+1PCS
C	Back cushion		2	G	WRENCH M6		1	
D	Cushions		2					

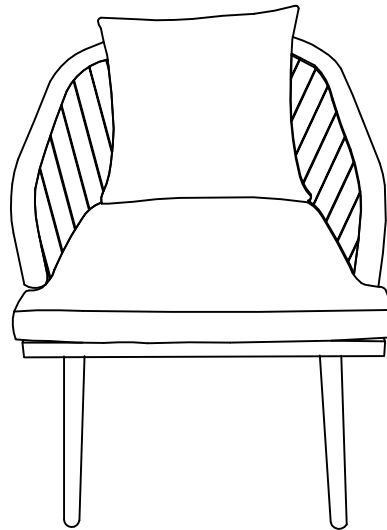

STEP 1

\*2

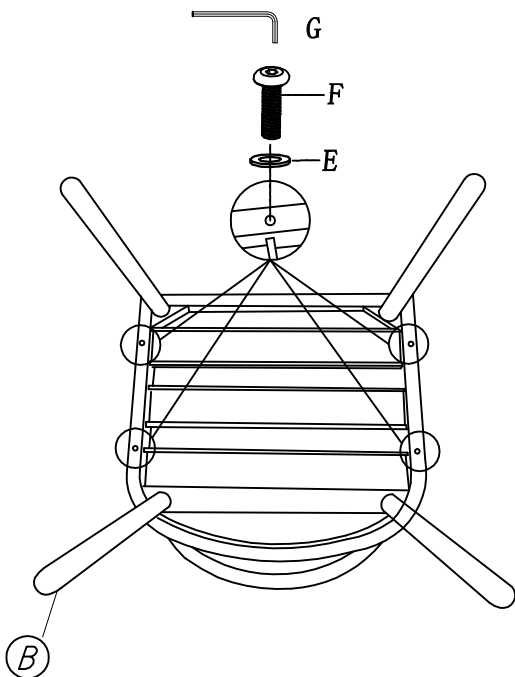

STEP 2

\*2

