

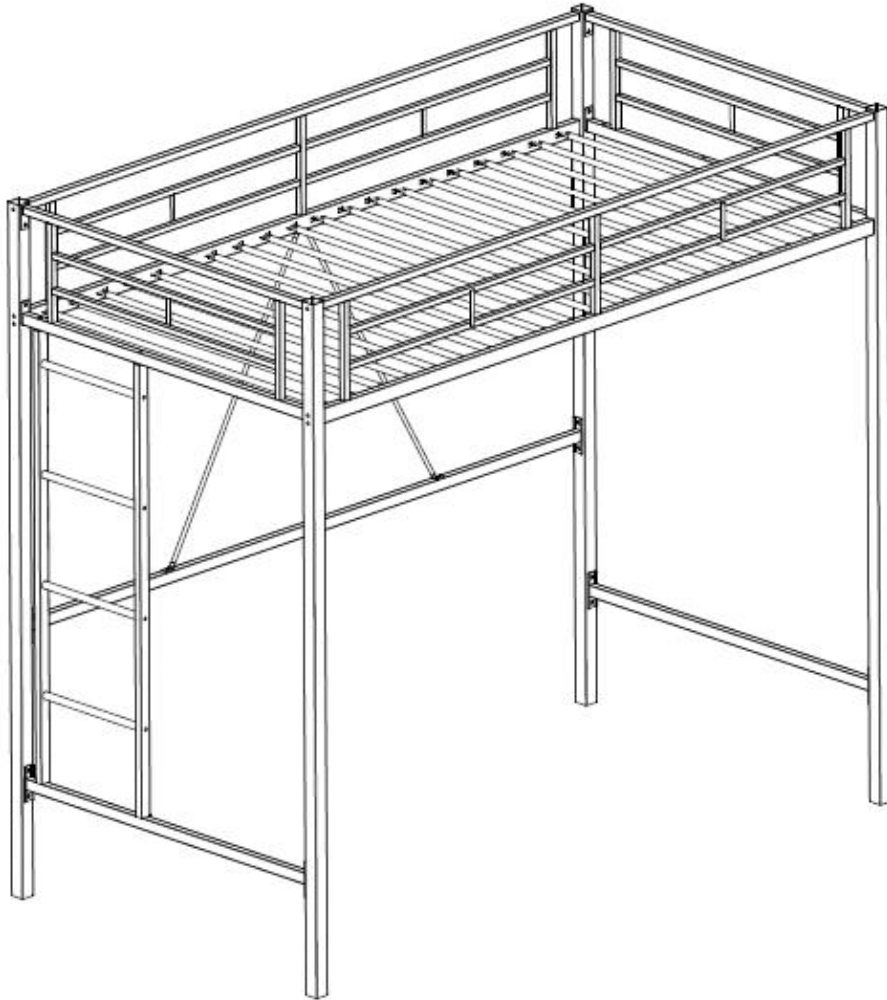









Instruction Manual

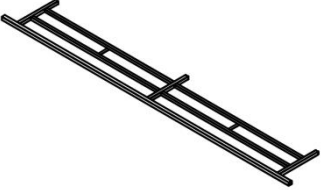
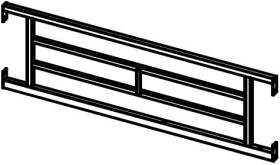





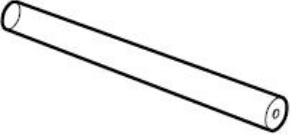





Metal Loft Bed

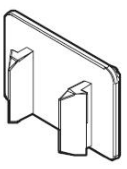

Parts List

A 2x 	B 1x 	C 1x 	D 1x 
E 2x 	F 2x 		
G 2x 	H 2x 		
I 2X 	J 2X 		
K 20X 	L1 4X 		

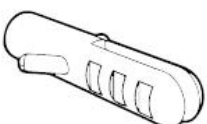
Hardware List

1	8x	2	9x	3	8x
					
M8x50		M6x55		M6x45	
4	10x	5	1x	6	1x
					
M6x15		M5		M4	
7	4x	8	12x	9	12x
					
M6x50		M8		M8x20	
10	40x	11	2x	12	2x
					
		M5x40			
13	2x	14	1x		
					
		M6x65			

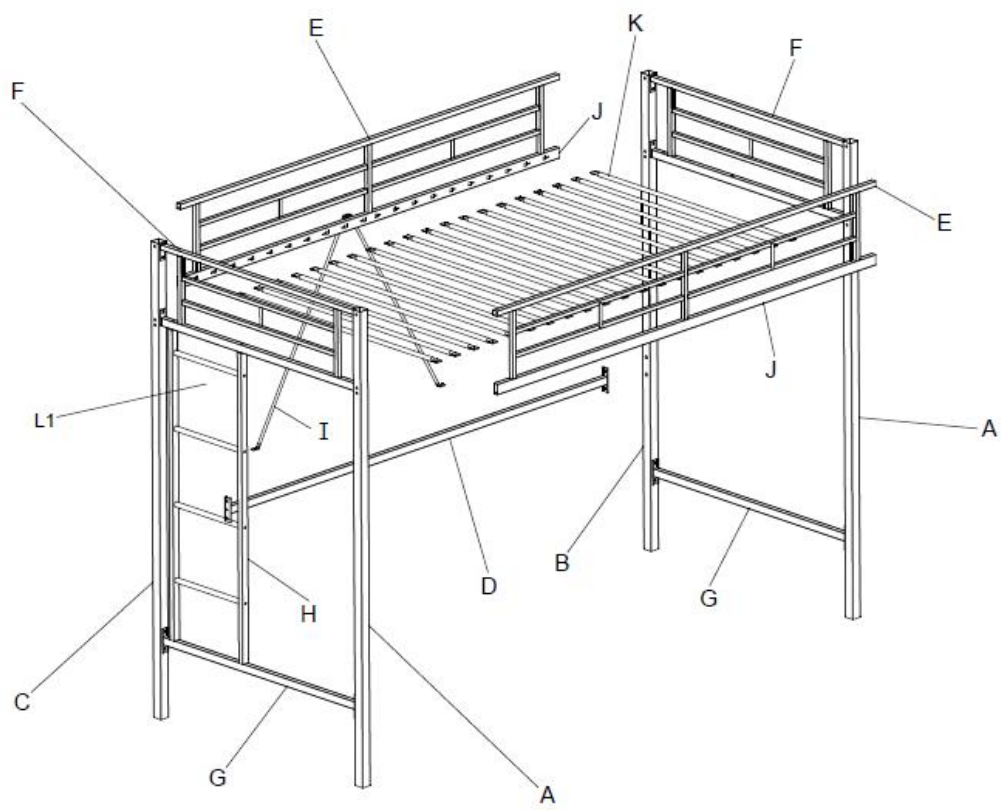

ASSEMBLY

Step1:

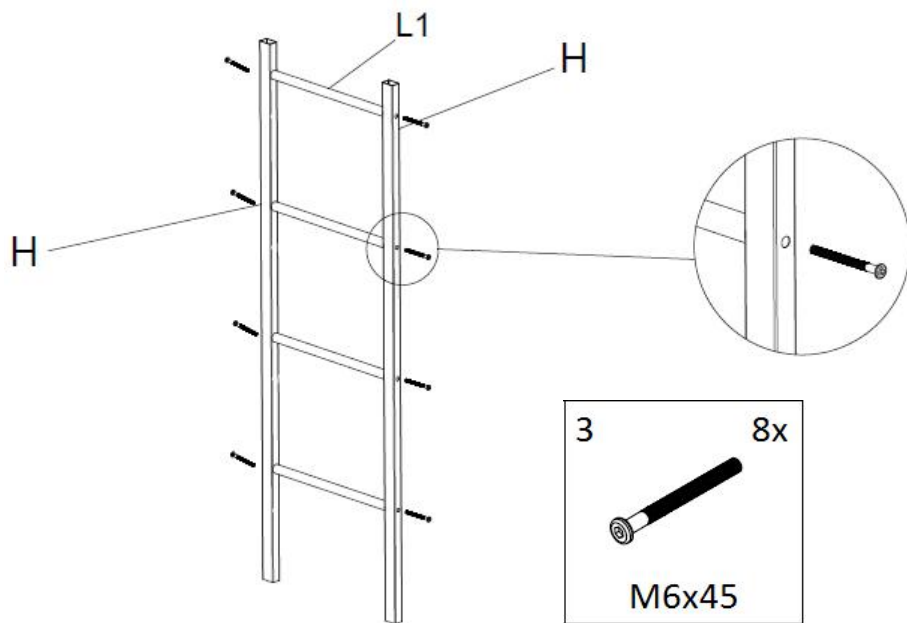

Step2:

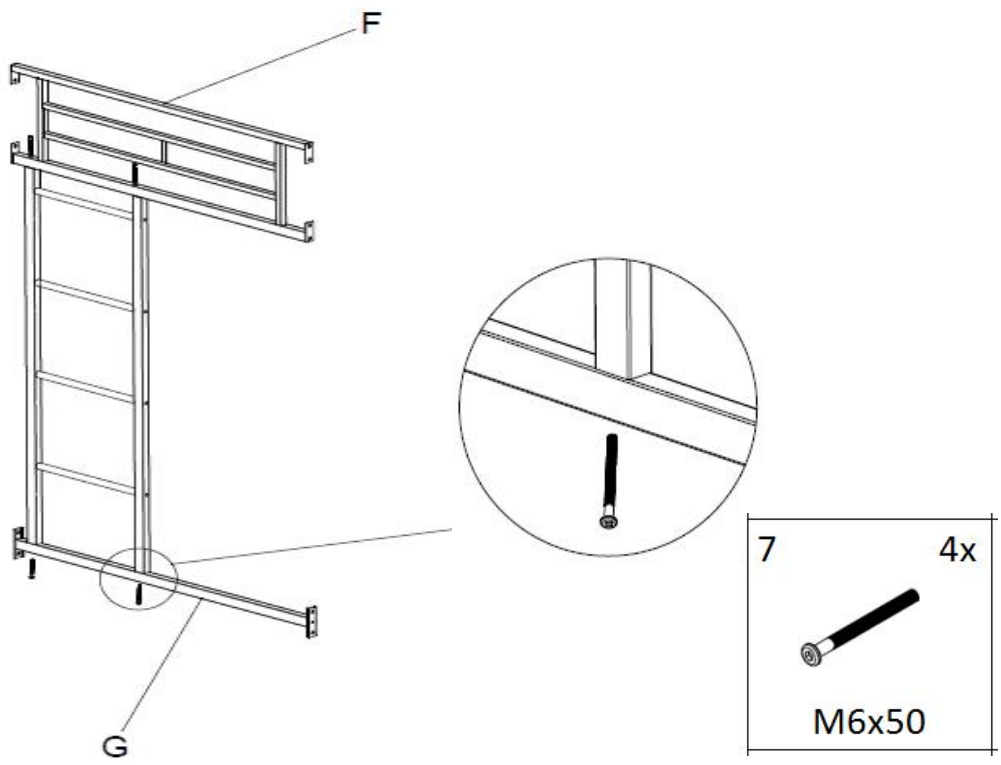

Step3:

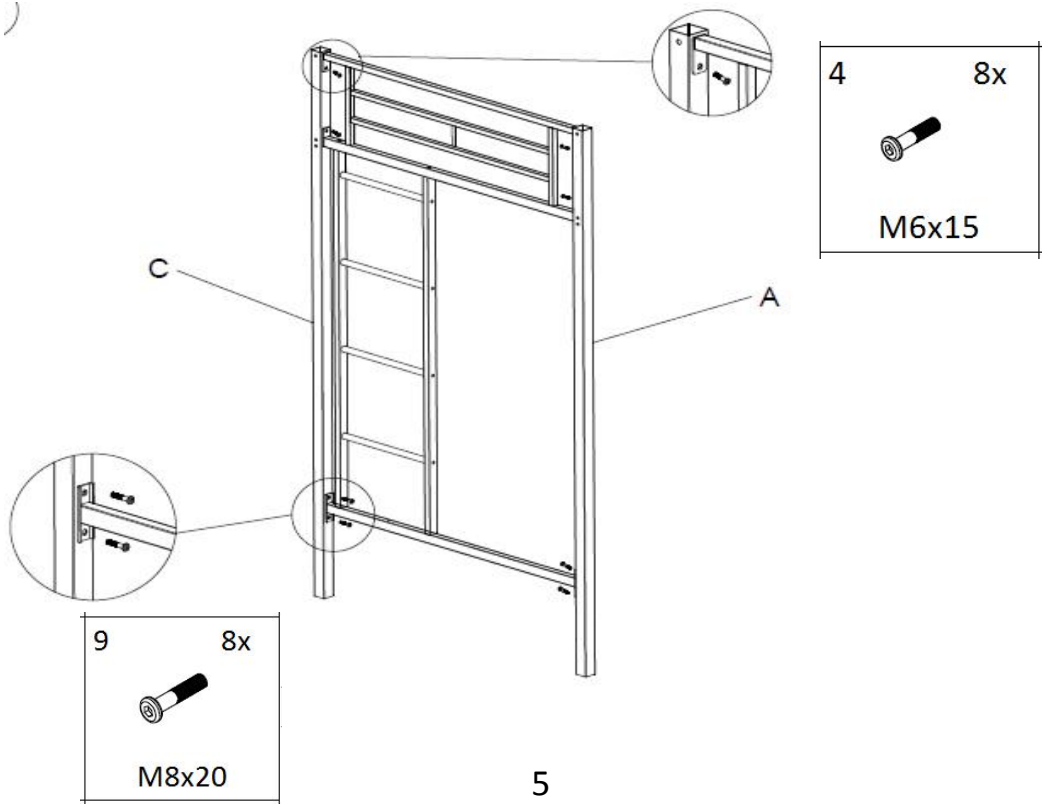

Step4:

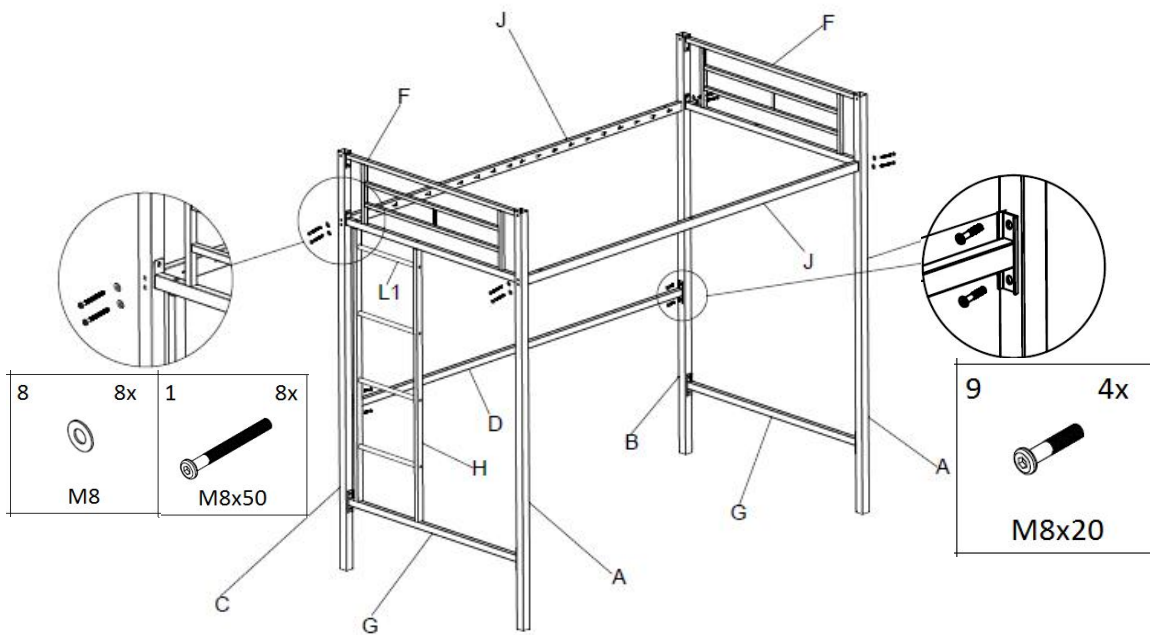

Step5:

THE STEPS OF SLATS INSTALLATION

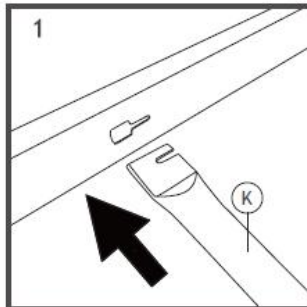

1. Insert slats into the hole on sidebar in the correct orientation.

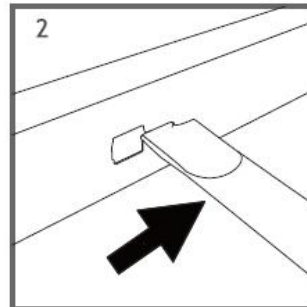

2. Push the slats into the gaps.

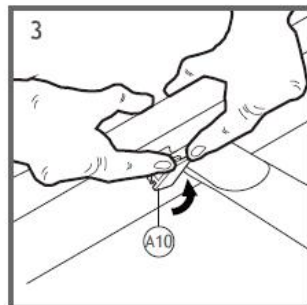

3. Put the plastic clamp into the lower part of the hole on 45 degree.

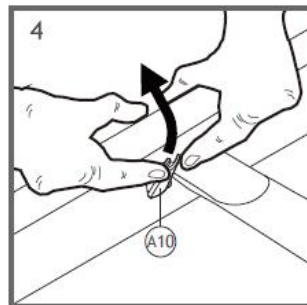

4. Press tight the upper part of clamp to fix its position.

Step6:

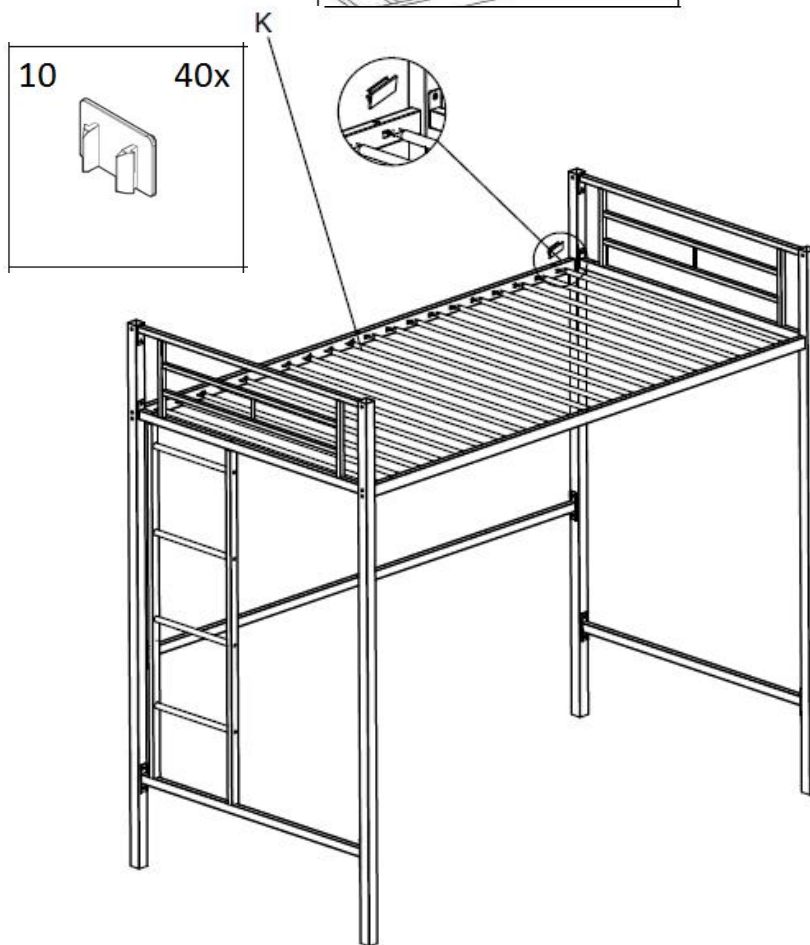
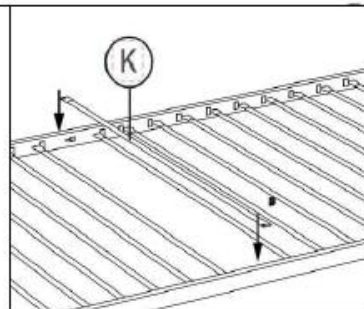
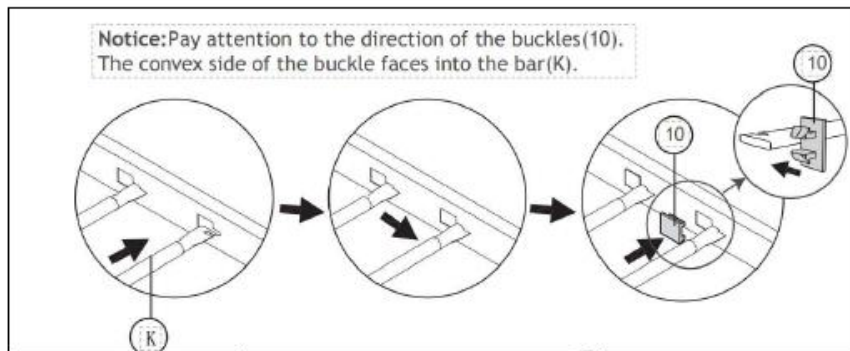

Step 7:

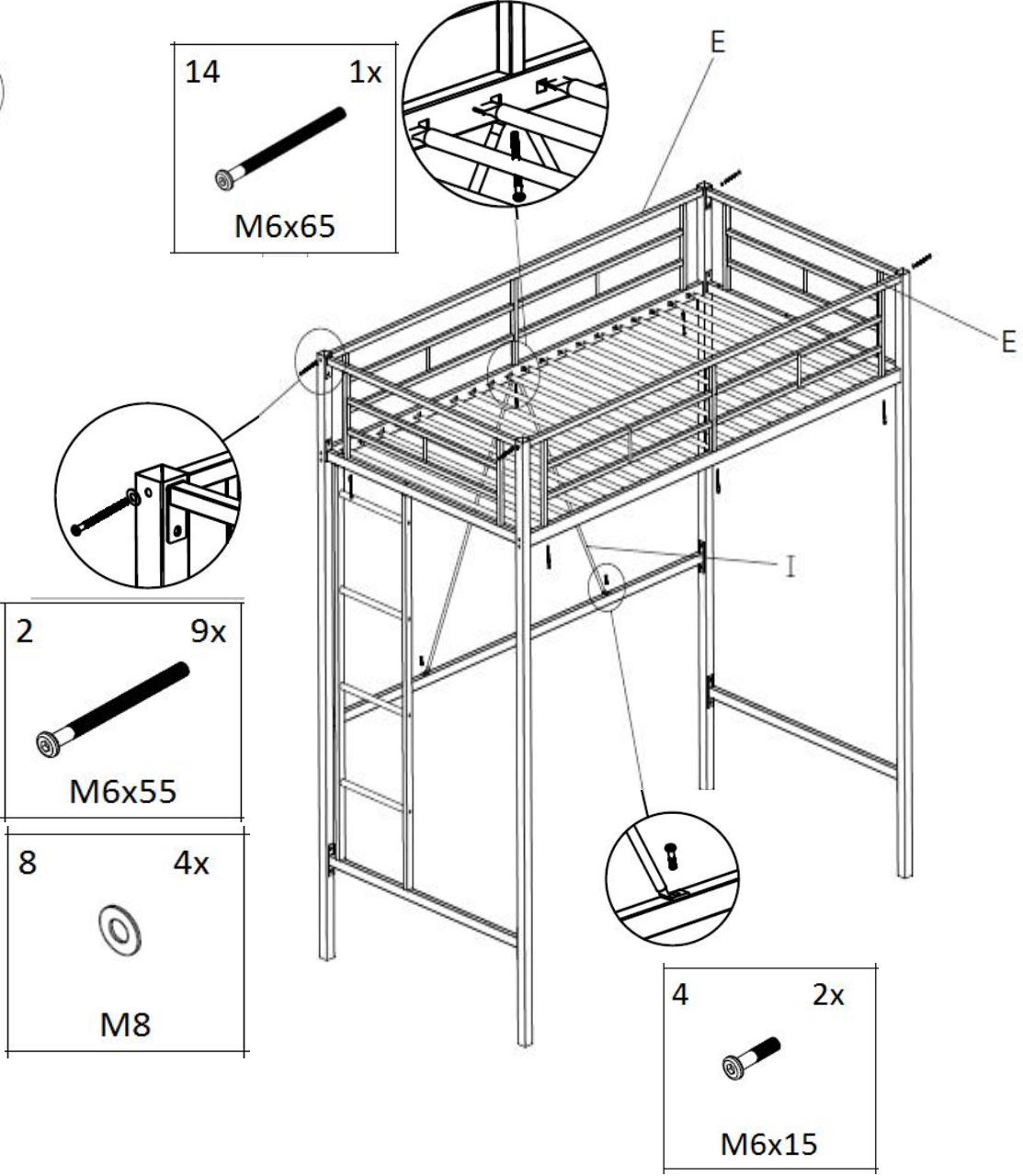

Step8:

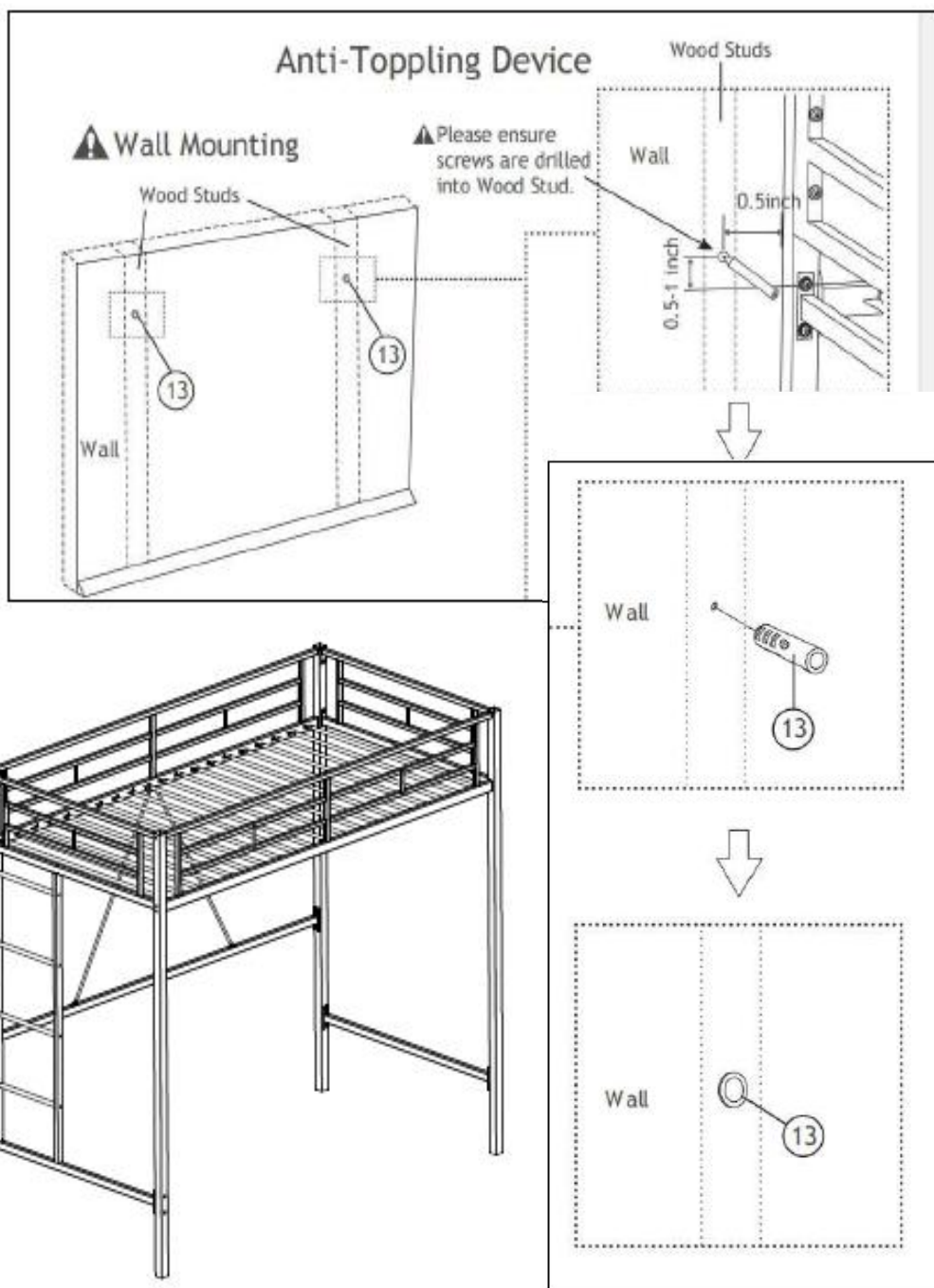

Step9:

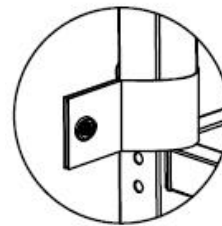
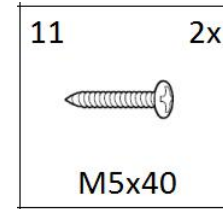
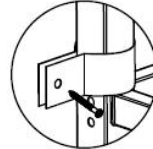
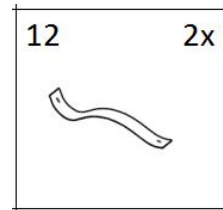
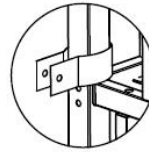
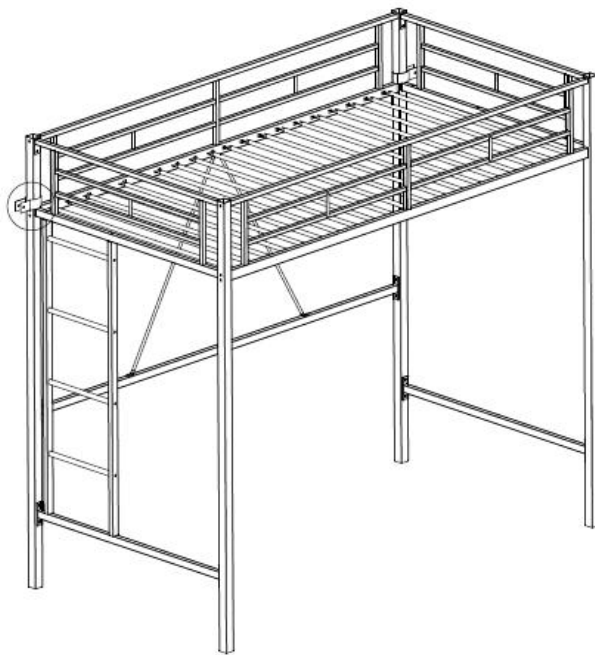

Warning:

Seller is responsible for the product-related issues occurred upon receipt, but will not be responsible for the personal injury, property damage or loss resulting from the incorrect assembly, improper use, inadequate maintenance or neglect of this product.