

EXPLOSION FIGURE

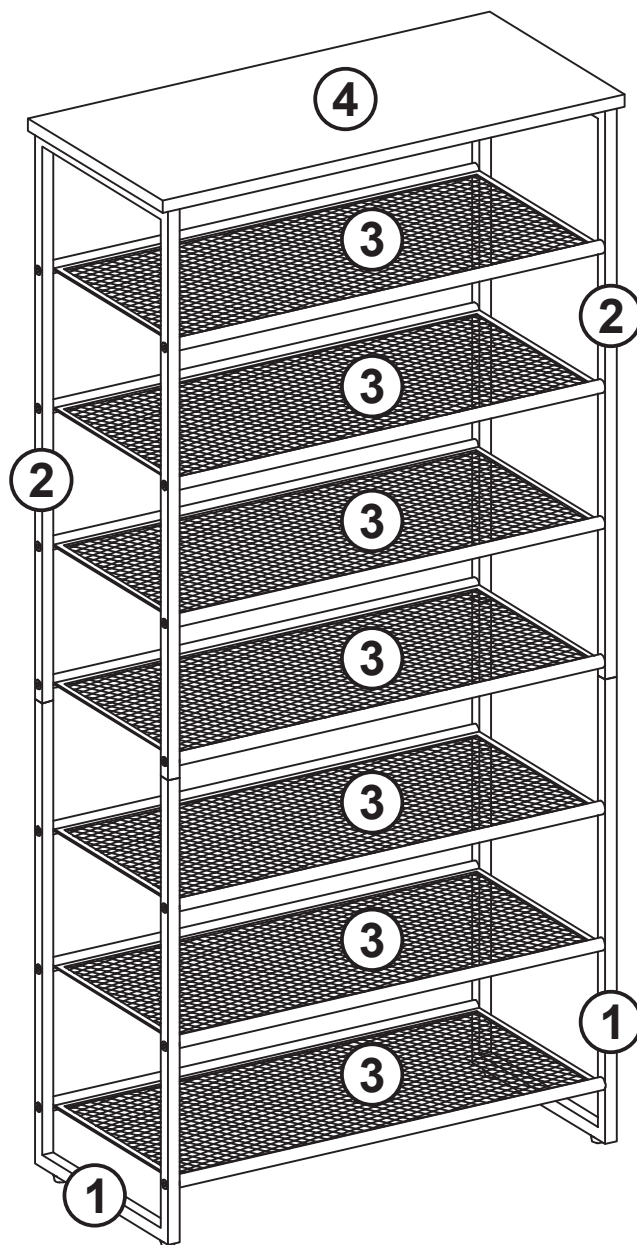

C x 4
Ø20*17

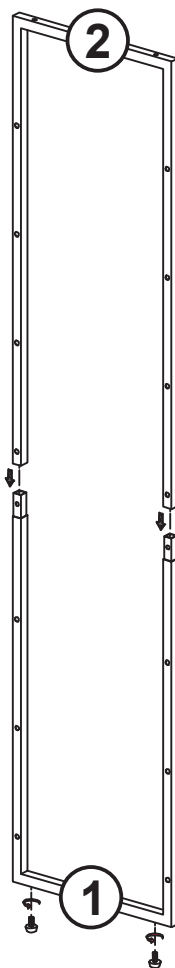
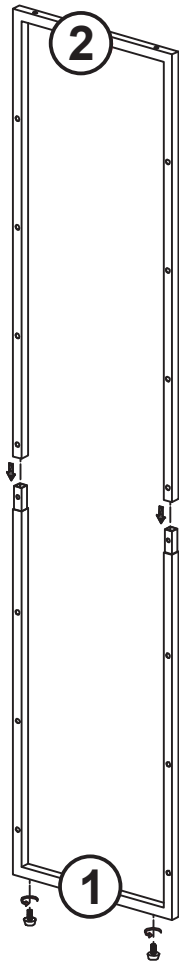

A x 28
M6*27

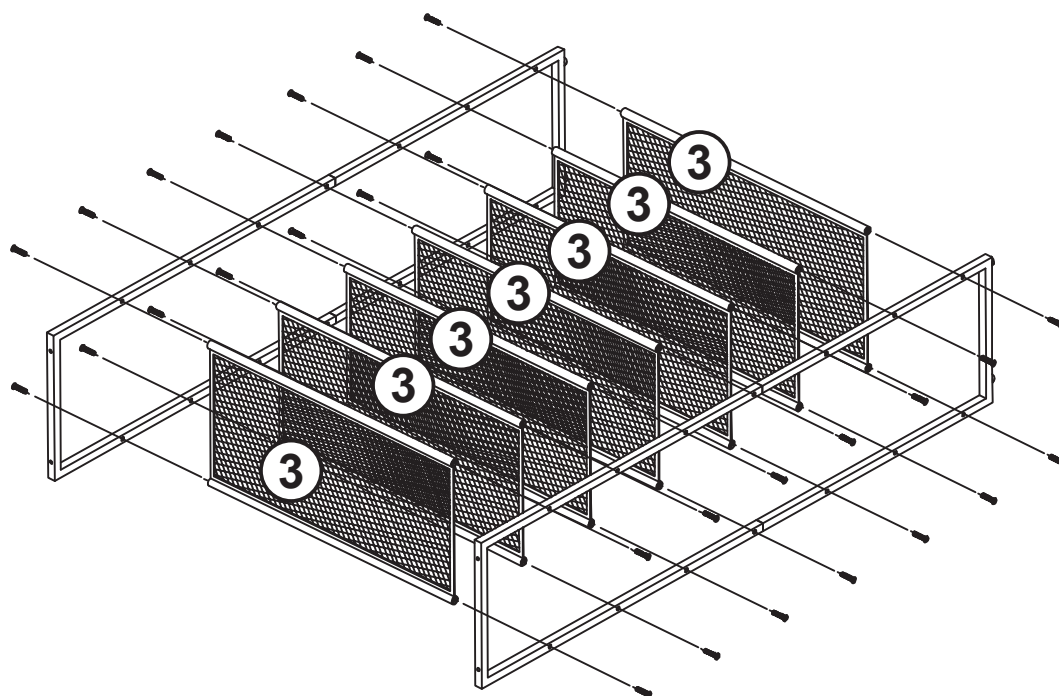

A x 4
M6*27

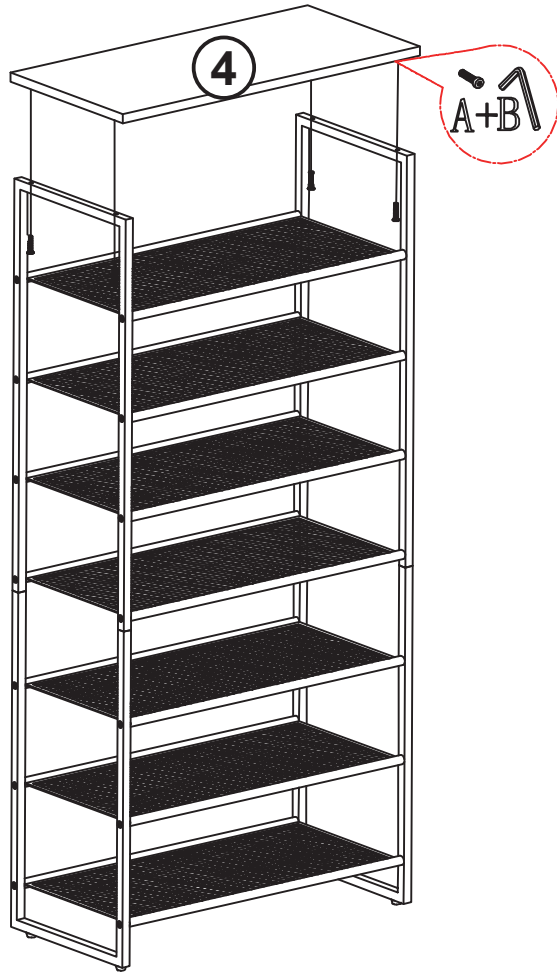
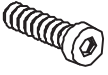

D x 2
M4*35

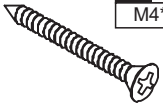

E x 2
Ø6*30

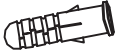

F x 2

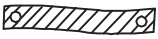

D+E+F

