

### Features

- 122 airjets release thousands of bubbles that surround, support, and massage the body.
- Variable-speed blower lets you adjust airjet massage intensity to 18 levels.
- Zones of Control™ feature allows you to target airjet massage to back, midsection, or feet.
- 8 hydromassage jets can be individually adjusted for water flow and direction.
- Variable-speed pump for adjusting hydromassage intensity.
- Built-in heater.
- Lighted keypads.
- Generous 6-foot length provides an incredibly spacious bathing area.
- Sloping backrest provides comfort.
- Slotted overflow allows for deep soaking.
- Immediate and manual purge cycles remove residual water from air channels after use
- Center drain.

### Material

- Acrylic

### Hydrotherapy

- BubbleMassage
- Whirlpool

### Installation

- Drop-in or under-mount.
- Requires 240V hard-wire electrical service.
- Under-mount installation requires kit K-592 (sold separately).

### Required Accessories

K-9698 Flexjet® Whirlpool Trim Kit  
K-7271 Slotted Overflow Bath Drain  
K-7272 Slotted Overflow Bath Drain



### Codes/Standards











ASME A112.19.7/CSA B45.10  
CSA B45.5/IAPMO Z124  
ASTM E162  
ASTM E662  
UL 1795  
CSA C22.2 No. 218.2  
CARB P2

### Kohler One-Year Limited Warranty

See website for detailed warranty information.

### Available Color/Finishes

*Color tiles intended for reference only.*

Color	Code	Description
	0	White
	96	Biscuit
	47	Almond
	NY	Dune
	95	Ice™ Grey
	G9	Sandbar
	33	Mexican Sand™
	K4	Cashmere
	58	Thunder™ Grey
	7	Black Black™

No change in measurements if connected with drain illustrated. (K-7272)

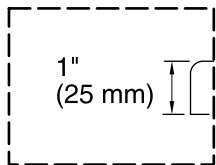

**Drop-in Rim Detail**

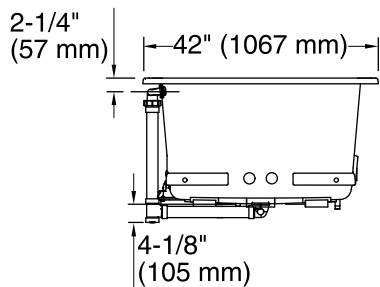

Blower Motor/  
Control Access  
30" (762 mm) W x  
15" (381 mm) H Min

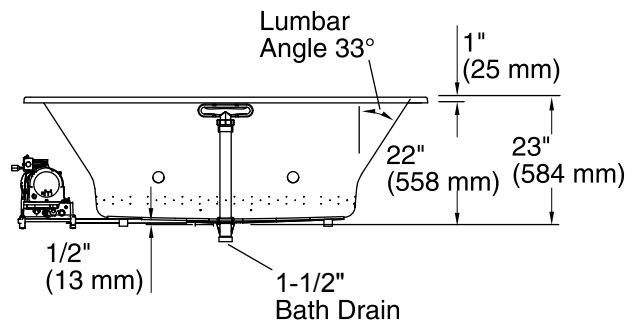
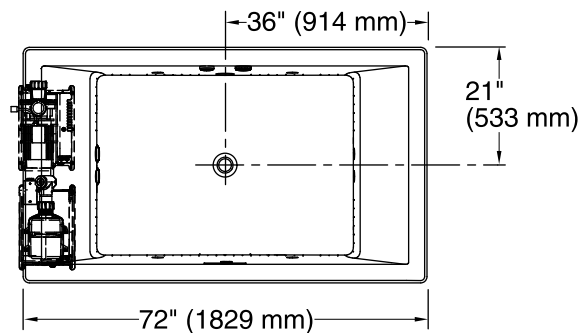

### Required Electrical Service

One dedicated circuit required, protected with Class A Ground-Fault Circuit-Interrupter (GFCI) or Residual Current Device (RCD).

Blower, Pump: 220-240 V, 20 A, 50/60 Hz

### Technical Information

All product dimensions are nominal.

Installation:	Drop-in/Under-mount
Drain location:	Reversible
Basin area, bottom:	45-3/4" x 32" (1162 mm x 813 mm)
Basin area, top:	66" x 36" (1676 mm x 914 mm)
Weight:	203 lbs (92.1 kg)
Minimum floor load:	64.1 lbs/ft <sup>2</sup> (313 kg/m <sup>2</sup> )
Water depth:	19" (483 mm)
Water capacity:	139 gal (526.2 L)
Cutout:	Drop-in, 71-1/2" x 41-1/2" (1816 mm x 1054 mm)
Template:	Under-mount, K-592, not required, not included
Under-mount kit:	K-592

### Notes

Measure your actual product for roughing-in details.

Install this product according to the installation guide.

**IMPORTANT!** Dry fit the drain assembly prior to installing the bath. The bath cannot be installed with all drain components attached.

Hot water supply should be 70% of capacity or greater. Installations will vary.