

User Manual Instruction & Care Guide

9-Light Flush Mount Crystal Chandelier

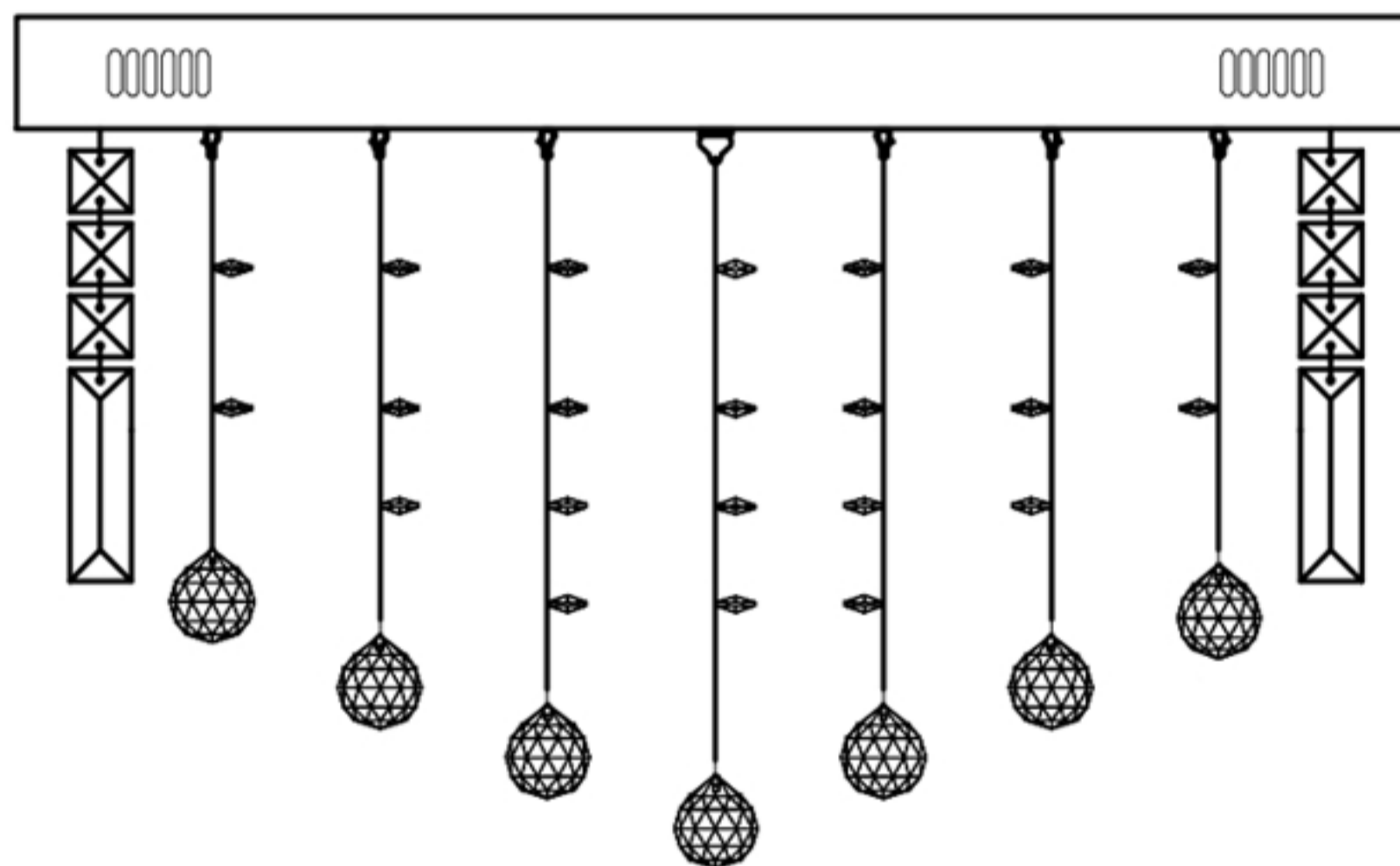

Any questions about product details, assembly & installation,
missing parts, shipments or any other issues
Feel Free to contact our Customer Service Team

Table of Contents

Table of Contents	1	Tools.....	2
Safety Information	1	Packing List.....	3
Warranty	1	Installation	3
Before Installation	2	Care and Cleaning	5
Planning the Installation	2	Troubleshooting	6

Safety Information



WARNING : Carefully read and understand the information in this manual before beginning assembly and installation. Failure to do so could lead to electric shock, fire or other injuries which could be hazardous or even fatal.



WARNING : Consult a qualified electrician with any electrical questions you may have.



IMPORTANT : Inspect the wire insulation for any cuts, abrasions, or exposed copper that may have occurred during shipping. If there is a defect in the wire, do not continue the assembly process.

Please call our Customer Service Team

Warranty

1-YEAR LIMITED WARRANTY

WHAT IS COVERED

The manufacturer warrants this lighting fixture to be free from defects in the materials and workmanship for a period of one (1) year from date of delivery. This warranty applies only to the original consumer purchaser and only to the products used in normal use. If this product is found to be defective, the manufacturer's only obligation, and your exclusive remedy, is the repair or replacement of the product at the manufacturer's discretion, provided that the product has not been damaged through misuse, abuse, accident, modifications, alterations, neglect or mishandling.

WHAT IS NOT COVERED

This warranty shall not apply to the finish on any portion of the product due to weathering, as this is considered normal wear. The manufacturer does not warrant and specially disclaims any warranty, whether expressed or implied, other than the warranty contained herein. The manufacturer specially disclaims any liability and shall not be liable for any consequential or incidental loss or damage, including but not limited to, any labor or expense costs involved in the replacement or repair of the product. Please also note that the warranty does not cover any problems caused by (a) misuse of the product, including commercial use, accidents, abuse, neglect, heat and humidity or (b) modification or any misuse contrary to the intended uses of the product, (c) damage caused by other equipment or (d) consequential damage, incidental damages or any costs related to construction, setup and assembly as incurred by 3rd party involvement. The warranties apply in normal residential use only and are not intended for commercial use.

BEFORE INSTALLATION

PLANNING INSTALLATION

1. Read all instructions before assembly.
2. Make sure you have all the parts listed in the packing-list and the quantity of each part is correct.
3. Inspect every part for defects that may have occurred during shipment.
4. To avoid damaging this product, assemble it on a soft, non-abrasive surface such as carpet or cardboard.
5. Keep your receipt (if applicable) and these instructions for proof of purchase.

NOTE:

If you find any missing or the defectiveness of the parts before installation, please contact our customer service team. Make sure this light is 100% ready for assembly and installation before you call an electrician to avoid any possible loss for it.

This light requires the use of 9 pieces 120V, 60Hz, max 40-Watt E12 base type bulbs (NOT included in the package). Do not exceed the recommended wattage.

TOOLS REQUIRED



Safety Goggles



Measuring Tape



Phillips Screwdriver



Flathead Screwdriver



Electric Drill

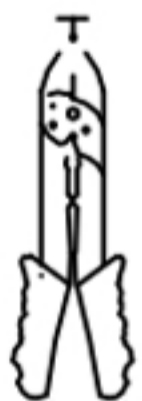

Wire Stripper



Wire Cutter



Ladder











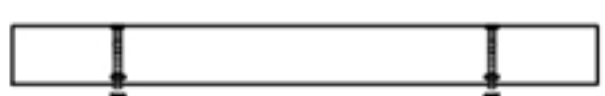

Electrical Tape

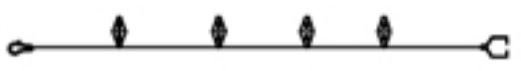
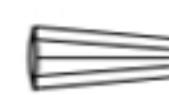

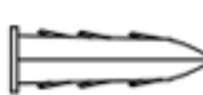
Pliers

Packing List

Part List					
Part Name	QTY/PCS	Part Pictures	Part Name	QTY/PCS	Part Pictures
Lamp Body	1		40MM Crystal Ball	42	
Part E	1x54		Glove	1	
Part A	1x1		Junction	3	
Part B	1x6		Plastic Plugs	5	
Part C	1x16		Self-taping Screws	5	
Part D	1x18		Crossbar Screws	3	

Installation Steps and Diagrams

Step 1: Install the Mounting Bracket & Lamp Body and Do the Wiring

 **DANGER:** Ensure the power is off at the main fuse box prior to beginning installation. Turn off the switch at the wall.

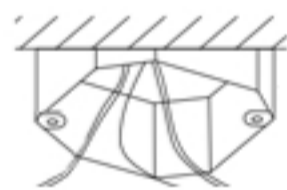

A- Existing Electrical Box

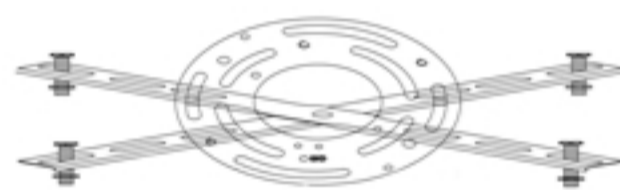

B- Mounting Bracket (Crossbar)

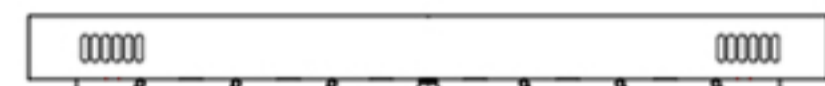

F- Lamp Body

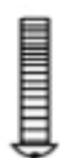

C- Cross-bar Screws



I- Screws



D- Light Wires



E- Junction



G- Cap Nuts



H- Bulbs

(Not included in the Package)

1. Screw the Crossbar(B) to the Existing Electrical Box(A) with the Cross-bar Screws(C).

2. Use the Self-taping Screws(I) to attach the 4 branches of the Crossbar(B) to the ceiling through the holes in the Crossbar(B) branches. (This is to provide more holding power for the light)

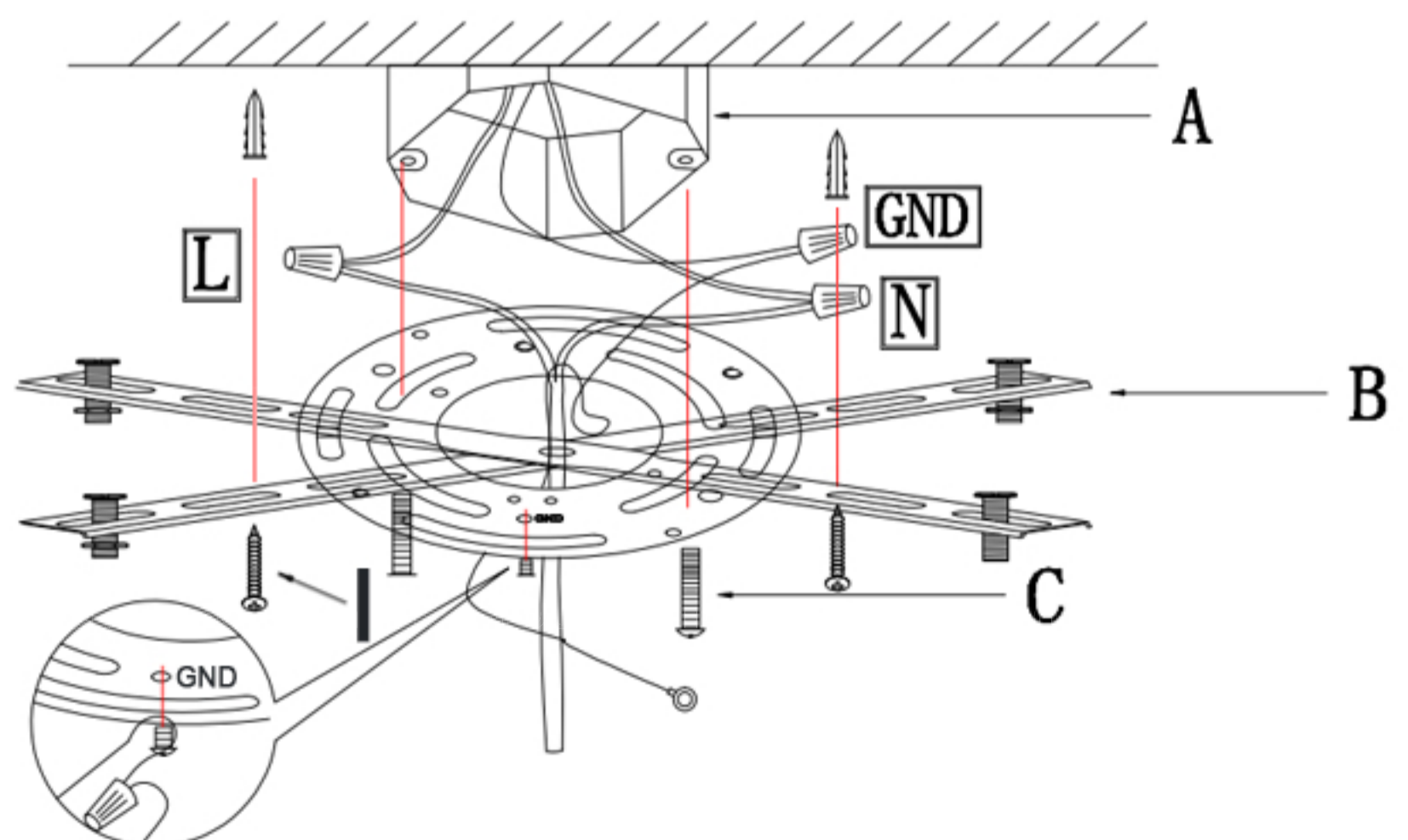

3. Connect the home wires from the Existing Electrical Box(A) with the Light Wires(D) on the Lamp Body(F), and secure them with the Junction(E).

4. Attach the Lamp Body(F) to the CrossBar(B) with the Cap Nuts(G).

NOTE: You will need an extra person who helps to hold the lamp in this step.

5. Install the light bulbs and then turn the light on to make sure every bulb works well.

NOTE: Install 9 pieces of E12 Base type bulbs-Maximum 40W for each halogen bulbs or 9W for each LED bulbs.

6. Remove the protective film all over the lamp body to reveal the real clear chrome surface of the lamp body after the testing of the bulbs.

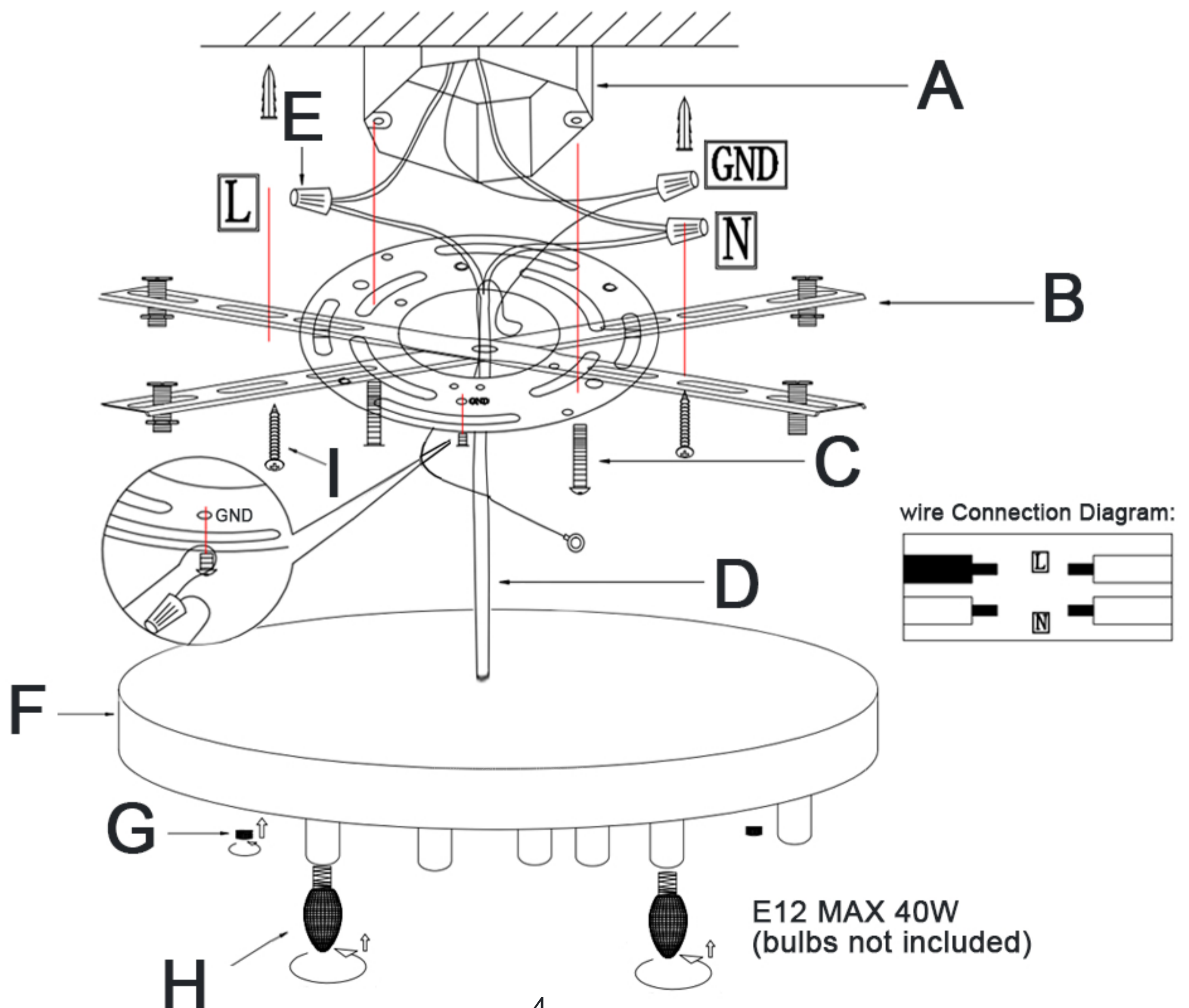
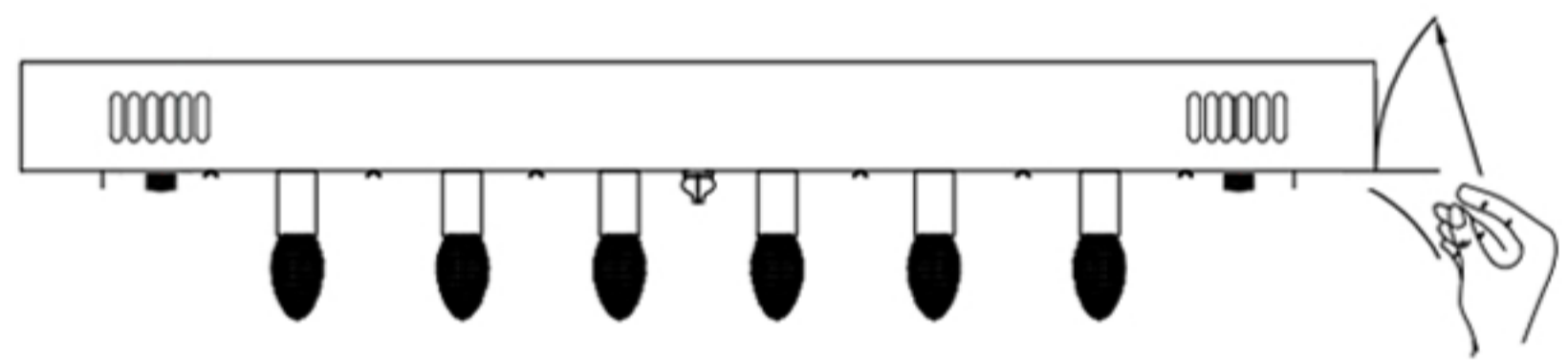
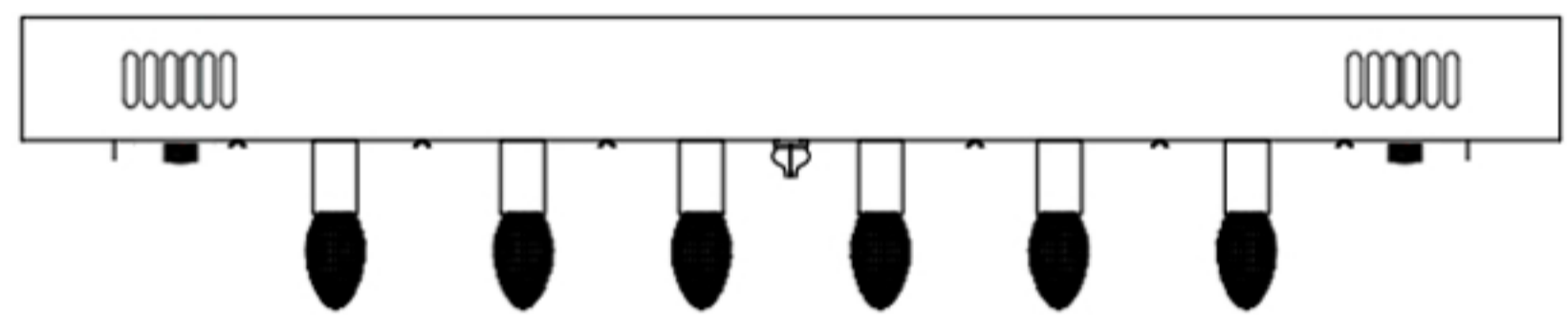
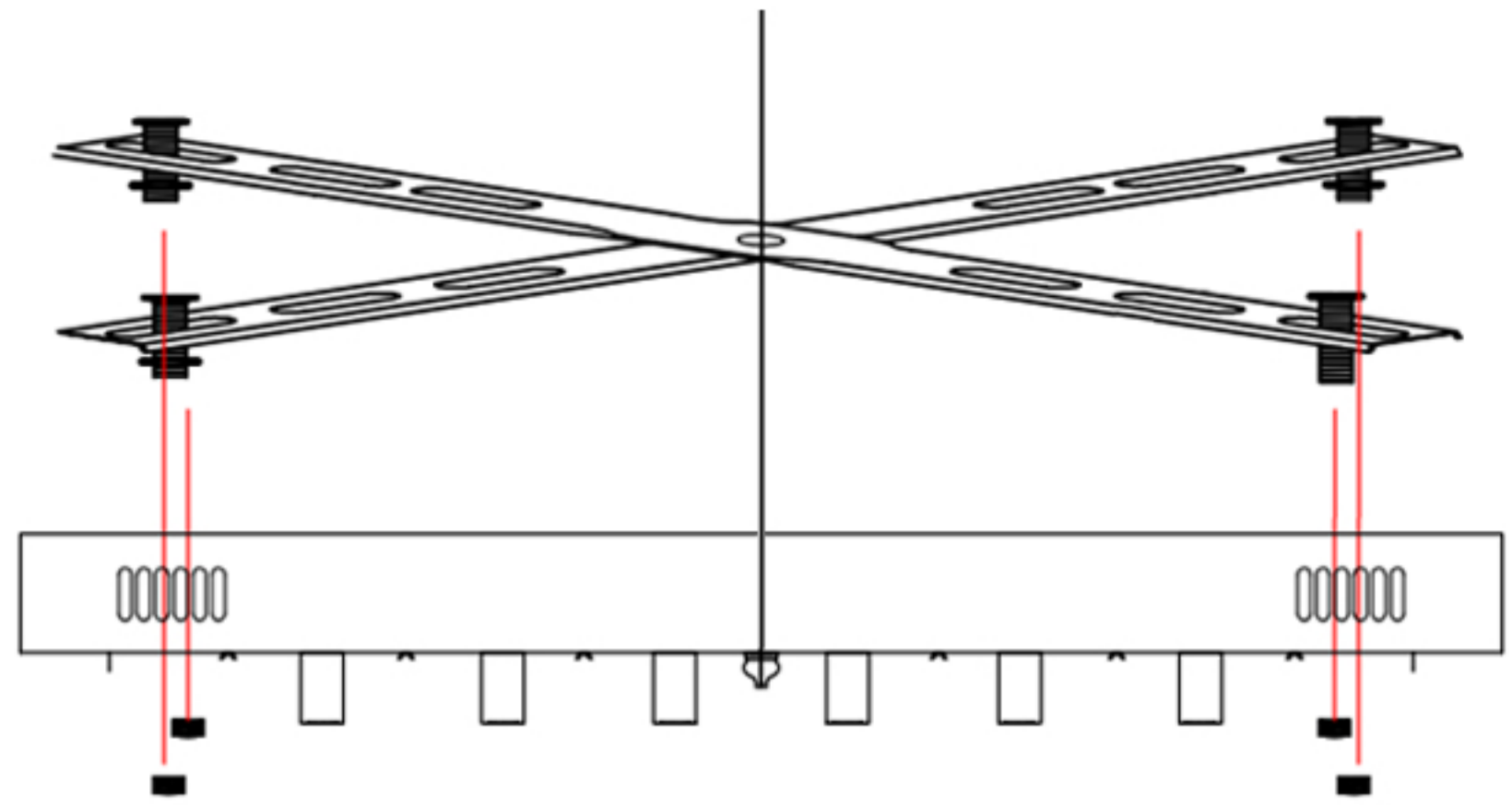

Step 2: Attach the Parts A to E to the Lamp Body

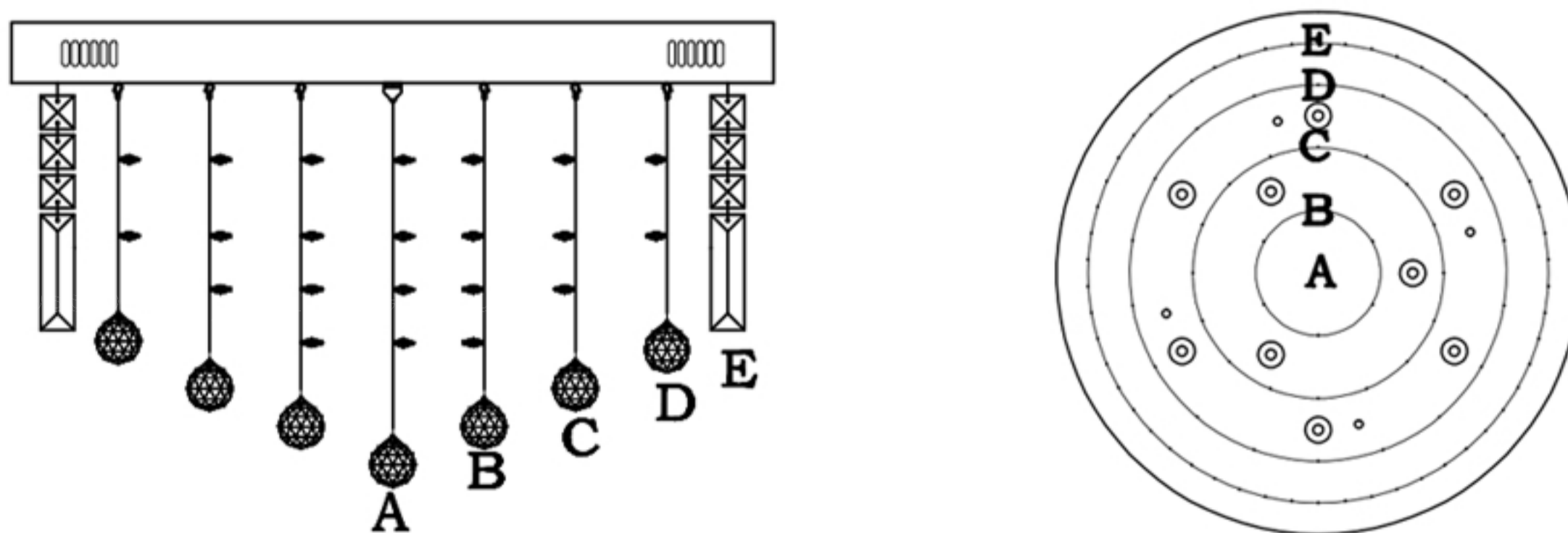

The diagram of how the crystal strands are corresponding to the light disk

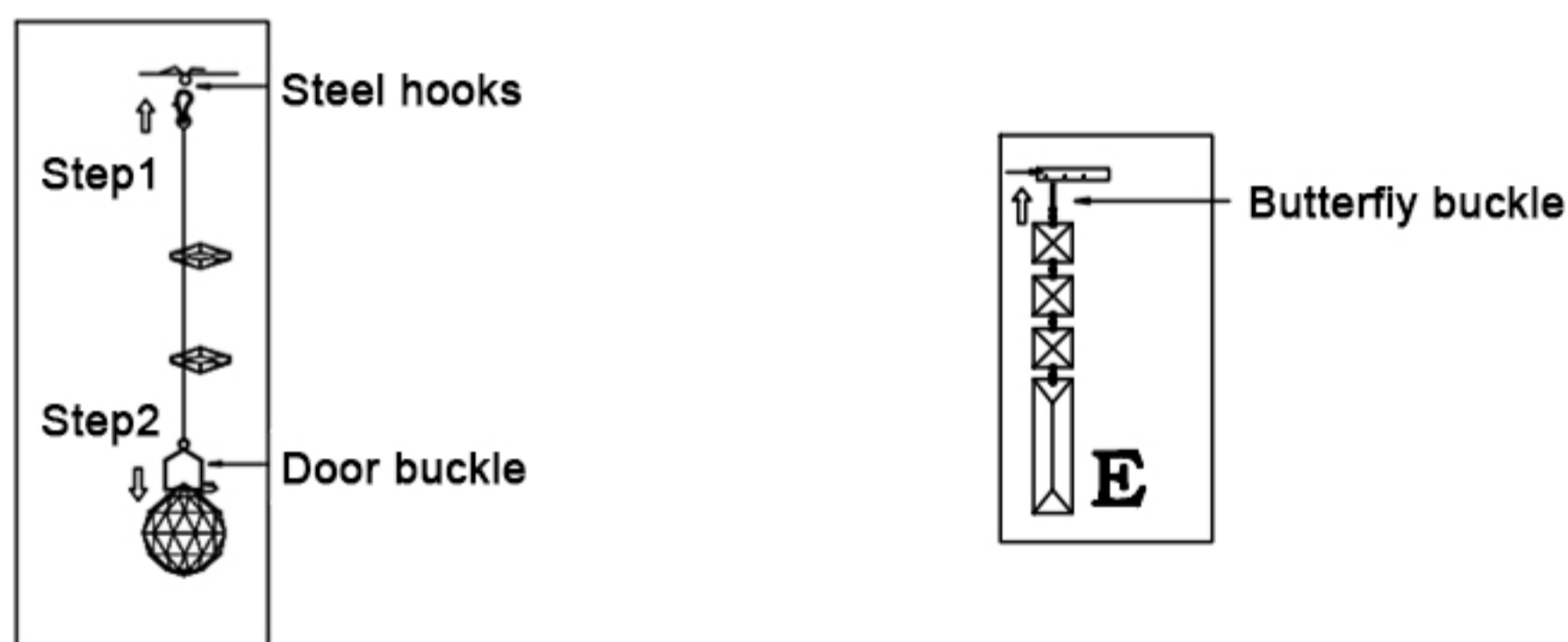

1. Attaching the crystal strands to the Lamp Body—we suggest an order of Part A first, and then B, and then C, and then D, and finally E.
2. Attach the crystal balls to the crystal strands—you can also attach the crystal balls to the crystal strands before attaching the crystal strands to the Lamp Body.
3. After all the crystal strands and the crystal balls are attached to the Lamp Body, turn on the lights again, and you will have a wonderful shining crystal light work for you!

NOTE: This is the final steps of the installation. The operation is fairly easy though indeed it is time consuming and requires patience. But you will find all your work here is worthy when you have this beautiful light shining for you in the end.

Care and Cleaning

Clean the fixture with a soft, dry cloth.

Do not use any cleaners with chemicals, solvents or harsh abrasives.

⚠ WARNING: Before attempting to clean the fixture, disconnect the power to the fixture by turning the breaker off or removing the fuse from the fuse box

Troubleshooting

Problem	Possible Cause	Solution
The bulb will not light.	The power is off.	Ensure the power supply is On.
	The circuit breaker is off.	Ensure the circuit breaker is in the On position.
The fuse blows or circuit breaker trips when the light is turned on.	The wires are crossed or the power wire is grounding out.	<ul style="list-style-type: none"><input type="checkbox"/> Check the wire connections.<input type="checkbox"/> Contact a qualified electrician or call the Customer Service Team at