

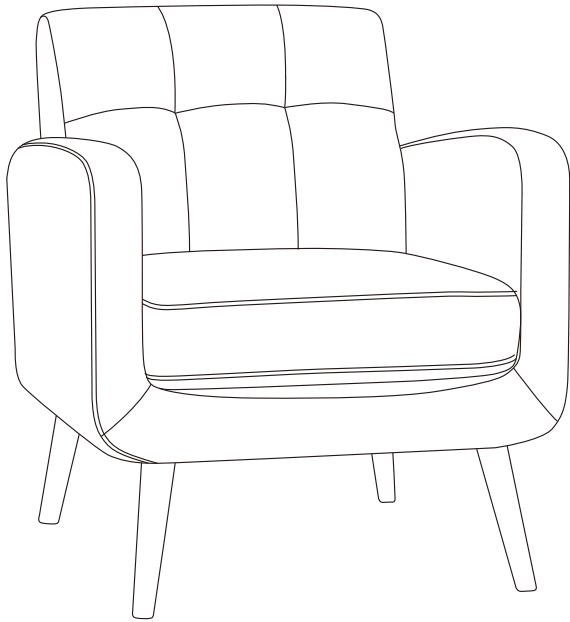







# ASSEMBLY INSTRUCTIONS



Ax1 	Ex4 
Bx1 	Fx4 
Cx4 	Gx4 
Dx4 	Hx1 

1

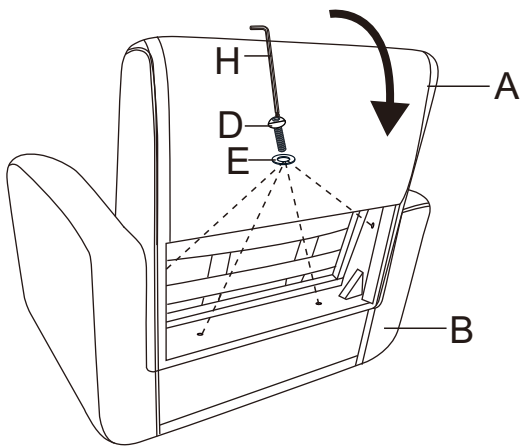

2

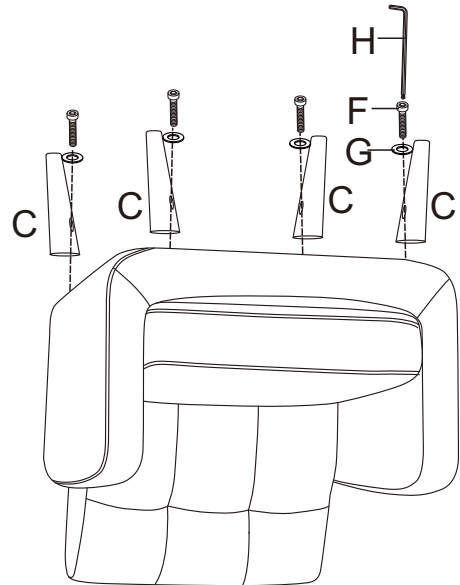

2

