

- 4** Insert backrest metal plates to both arms as shown below. Ensuring it is correctly in place.

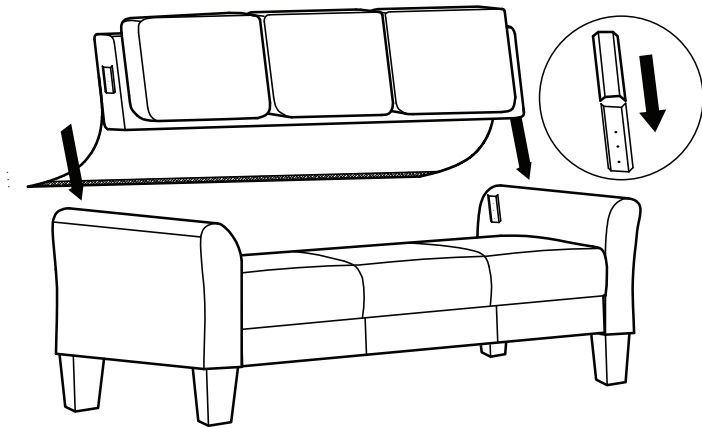

- 5** Finally, stretch and pull down rear cover evenly before securing velcro strip to seat base. Repeat if necessary for better fit.

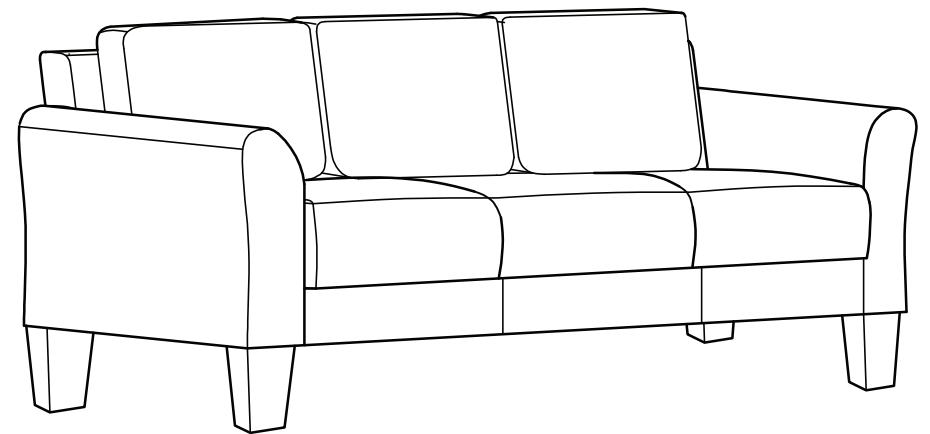
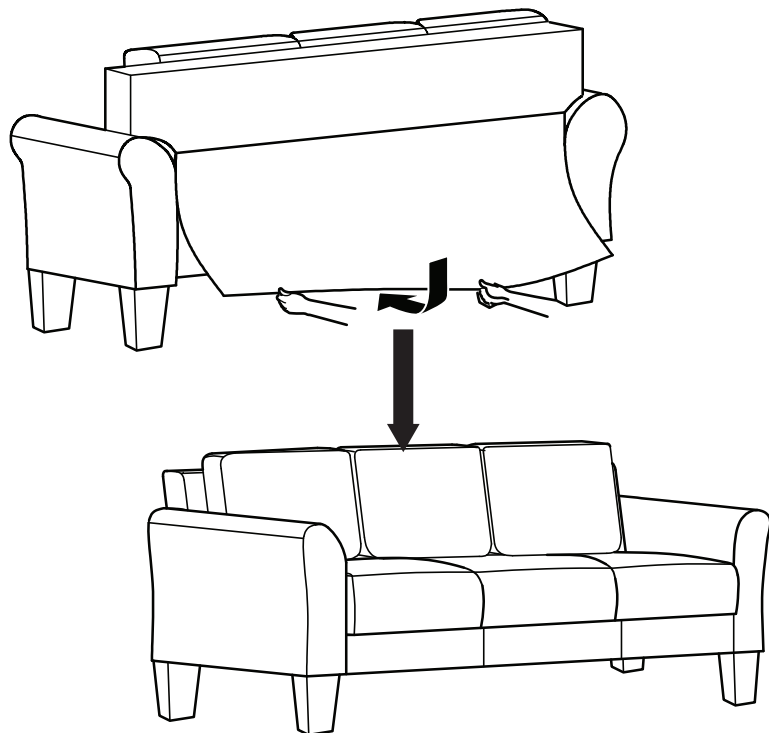

ROLL ARM SOFA
ASSEMBLY INSTRUCTIONS

PARTS AND HARDWARE

Avoid using sharp objects such as a knife to open packing as you may accidentally damage the upholstery.

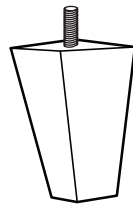

Leg
4x



M10 Washer
(Outer Dim. 45mm)
4x

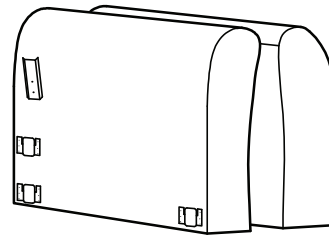

Arm
1 Pair

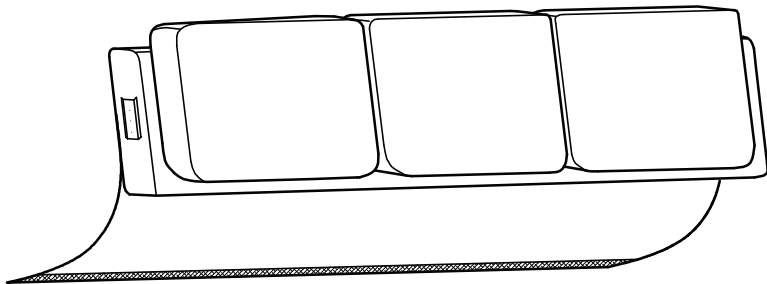

Backrest
1x

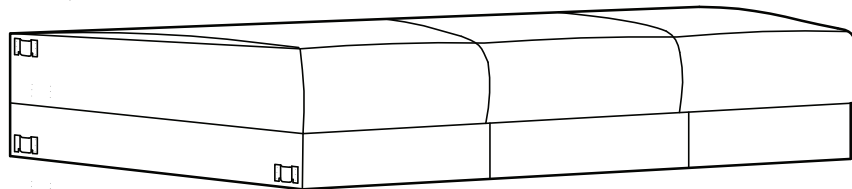

Seat Body
1x

ASSEMBLY INSTRUCTIONS

CAUTION: At least two adults are required to safely complete performing this task. Other lifting attempts may risk back injury due to large and heavy part(s).



- 1 Carefully unpack parts/hardware from storage of seat body and place on a clean flat surface.

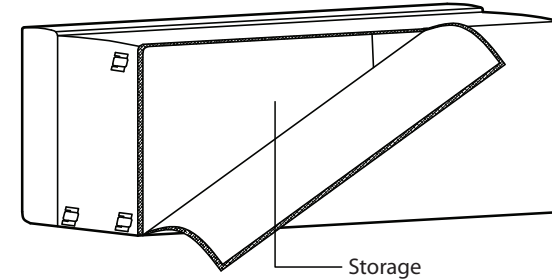

- 2 Place both arms as shown below, secure two legs and plastic washers into pre-drilled holes on the bottom of arms. Please avoid overtightening.

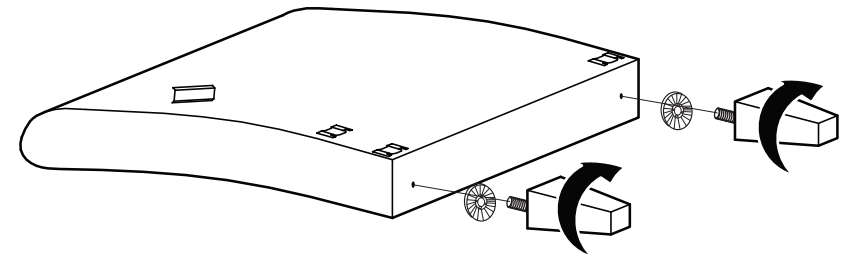

- 3 Carefully lift and turn assembled arms onto its legs. Insert seat body metal plates to both arms as shown below. Ensure it is correctly in place.

