

ASSEMBLY INSTRUCTION

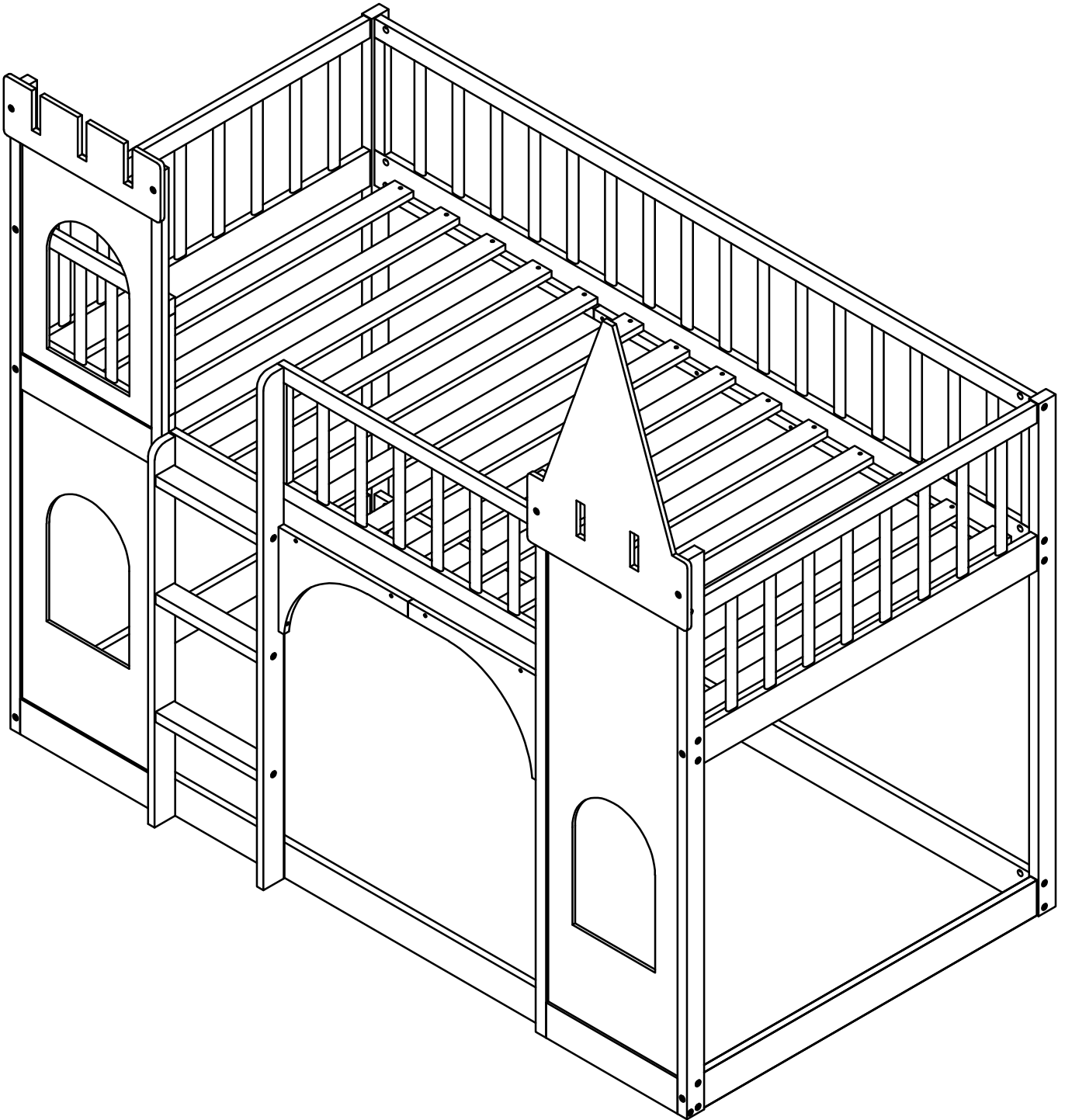

! SAFETY WARNINGS !

1. This bed is designed for use only mattress (es) meeting the following specifications on the upper bunk.

Upper bed Bed Type	Length	Width	Thickness
<i>Twin Standard</i>	<i>74" - 75"</i>	<i>38 1/2"</i>	<i>6" max</i>

2. Replacement parts, including additional guardrails, maybe obtained from any of our dealers
3. Follow the information on the warnings appearing on the upper bunk bed end structure and on the carton. Do not remove warning label from bed
4. Always use the recommended size mattresses or mattress supports, or both, to help prevent the likelihood of entrapment or falls.
5. Surface of mattress must be at least 5" (127mm) below the upper edge of guardrails
6. Do not allow children under 6 years of age to use the upper bunk.
7. Periodically check and ensure that the guardrail, ladder, and other components are in their proper position, free from damage, and that all connectors are tight.
8. Do not allow horseplay on or under the bed and prohibit jumping on the bed.
9. Always use the ladder for entering and leaving the upper bunkAlways use the ladder for entering and leaving the upper bunk.
10. Do not use substitute part. Contact the manufacture or dealer for replacement part
11. Use of a night light may provide added safety precaution for a child using the upper bunk..
12. Always use guardrails on both long sides of the upper bunk. If the bunk bed will be placed next to the wall, the guardrail that runs the full length of the bed should be placed against the wall to prevent entrapment between the bed and wall.
13. The use of water or sleep flotation mattresses is prohibited
14. **STRANGULATION HAZARD** - Never attach or hang items to any part of the bunk bed that are not designed for use with the bed; for example, but not limited to, hook, belts and jump ropes
15. Keep these instruction for future reference
16. Prohibit more than one person on upper bunk
17. We recommend assembling your bunk bed on the shipping carton to protect your floor or carpet
18. Be certain all staples are out of the box before beginning assembly on the shipping carton.

ASSEMBLY INSTRUCTION

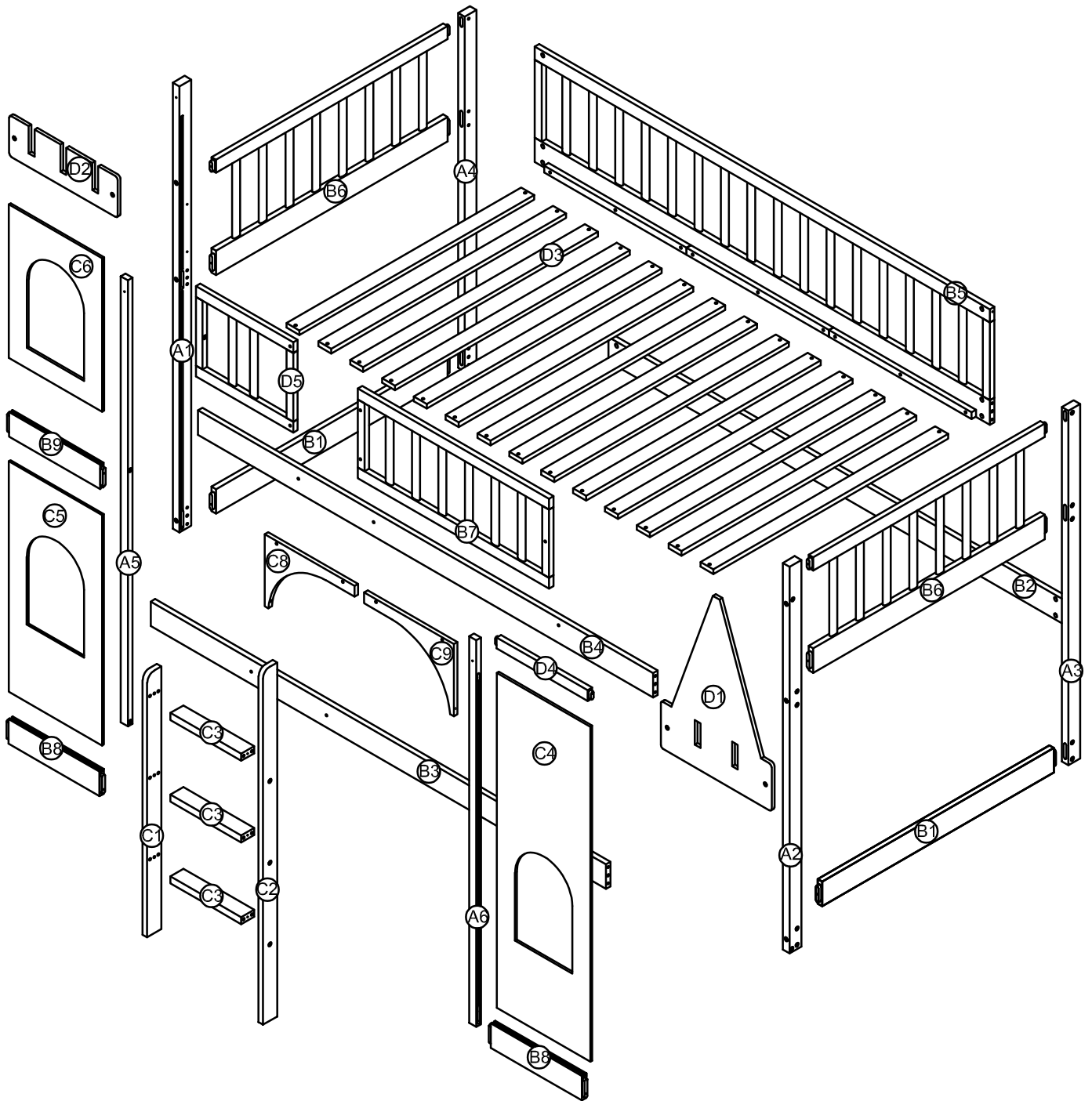

Part List & Hardware List

C3

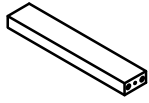

Step Ladder-3pcs

C8

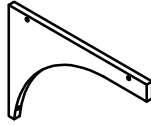

Panel-1pc

C9

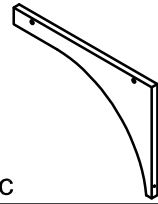

Panel-1pc

D1

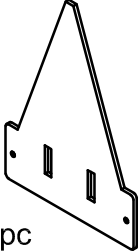

Panel(Right)-1pc

D3

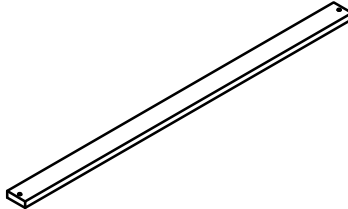

Slats-14pcs

D5

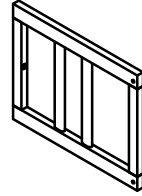

Front Frame-1pc

B1



WoodBar(Side)-2pcs

B6

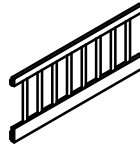

Side Frames-2pcs

B7

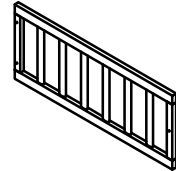













Front Frame-1pc

C1

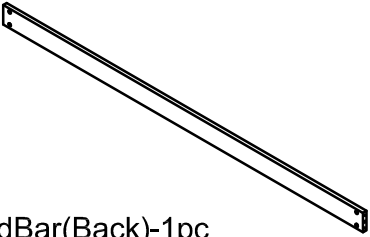
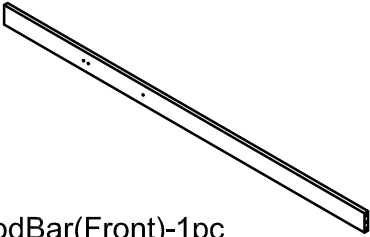
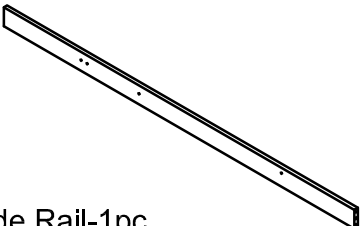
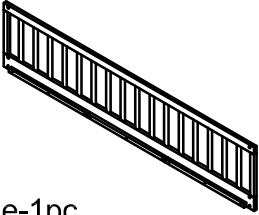

Side Ladder-1pc

Part List

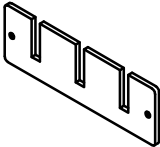
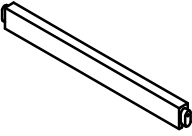
<p>A1</p>  <p>Leg-1pc</p>	<p>A2</p>  <p>Leg-1pc</p>	<p>A3</p>  <p>Leg-1pc</p>
<p>A4</p>  <p>Leg-1pc</p>	<p>A5</p>  <p>WoodBar(Left)-1pc</p>	<p>A6</p>  <p>WoodBar(Right)-1pc</p>
<p>C5</p>  <p>Panel(Left)-1pc</p>	<p>B2</p>  <p>WoodBar(Back)-1pc</p>	<p>B3</p>  <p>WoodBar(Front)-1pc</p>
<p>B4</p>  <p>Side Rail-1pc</p>	<p>B5</p>  <p>Back Frame-1pc</p>	<p>C6</p>  <p>Panel(Left)-1pc</p>
<p>C4</p>  <p>Panel(Right)-1pc</p>	<p>B8</p>  <p>WoodBar(Front)-2pcs</p>	<p>B9</p>  <p>WoodBar(Front)-1pc</p>
<p>C2</p>  <p>Side Ladder-1pc</p>	<p>D2</p>  <p>Panel(Left)-1pc</p>	<p>D4</p>  <p>WoodBar(Front)-1pc</p>

Hardware List

1



M4 x 30 mm
Wood Screws 34pcs

2

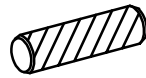

Ø10 x 40 mm
Wood dowel 20pcs

3



Allen Key 1pc

4



Screws 1/4" x70
12pcs

5



Screws 1/4" x50
14pcs

6



Screws 1/4" x40
5pcs

7

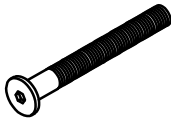

Ø1/4" x 70 mm
Hex-Head bolts 18pcs

8



Screws 1/4" x30
13pcs

9



Ø1/4" x 13 mm
Horizontal-Hole bolts 18pcs

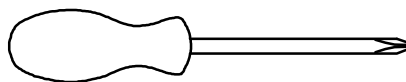

Assembly Tools Required (Not Included)

STEP1: Following below illustration.

4



6(pc)

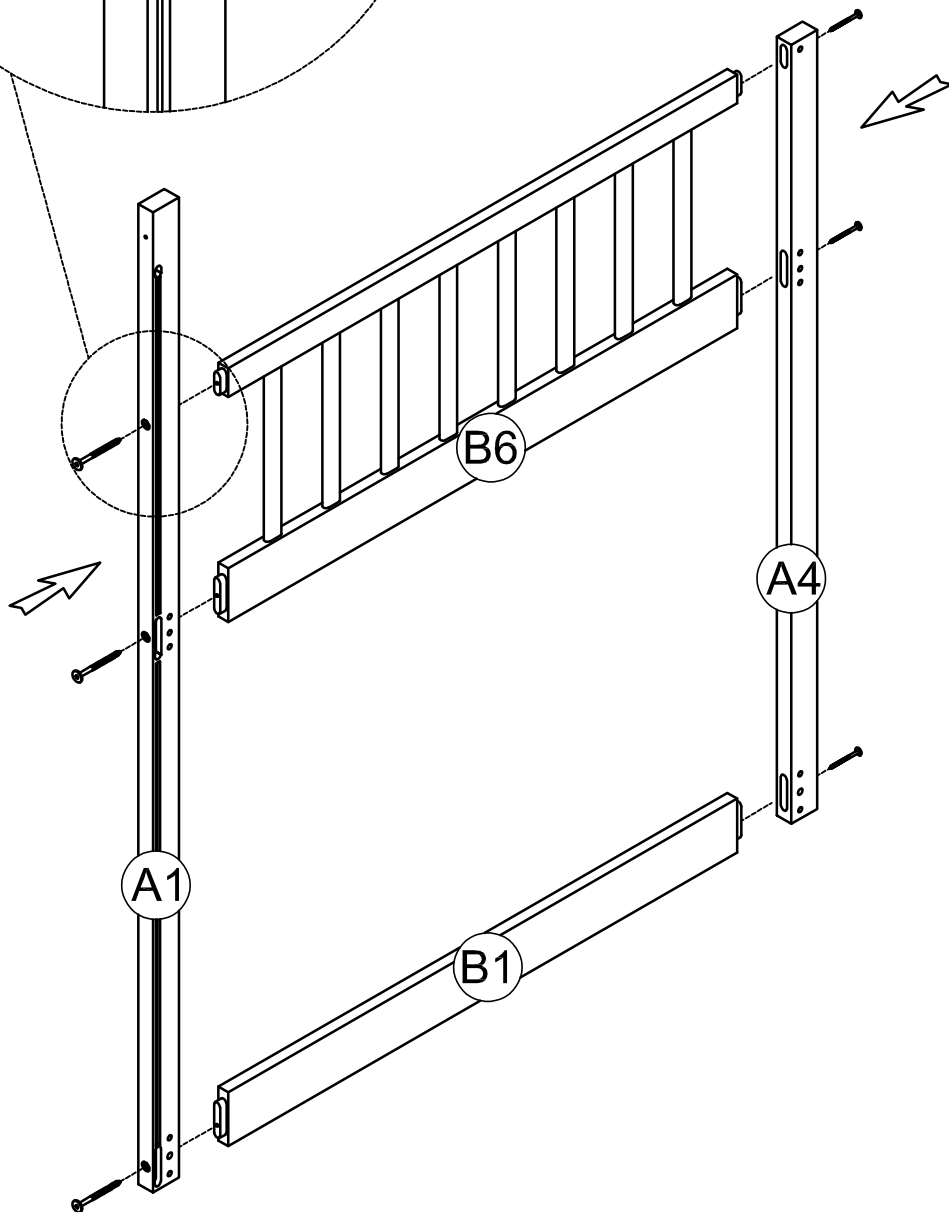
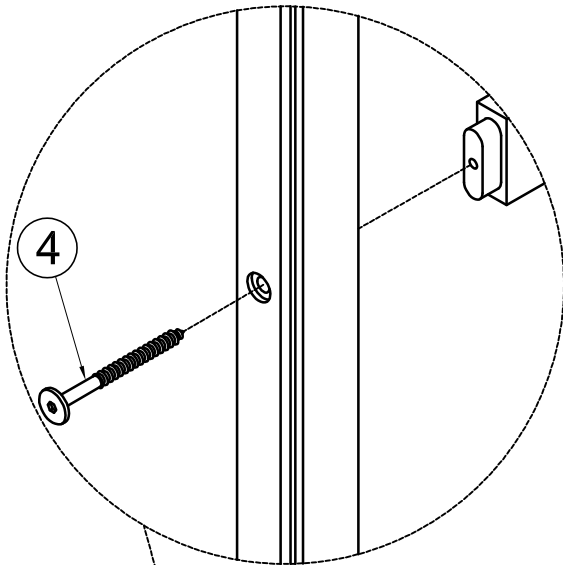

STEP2: Following below illustration.



4

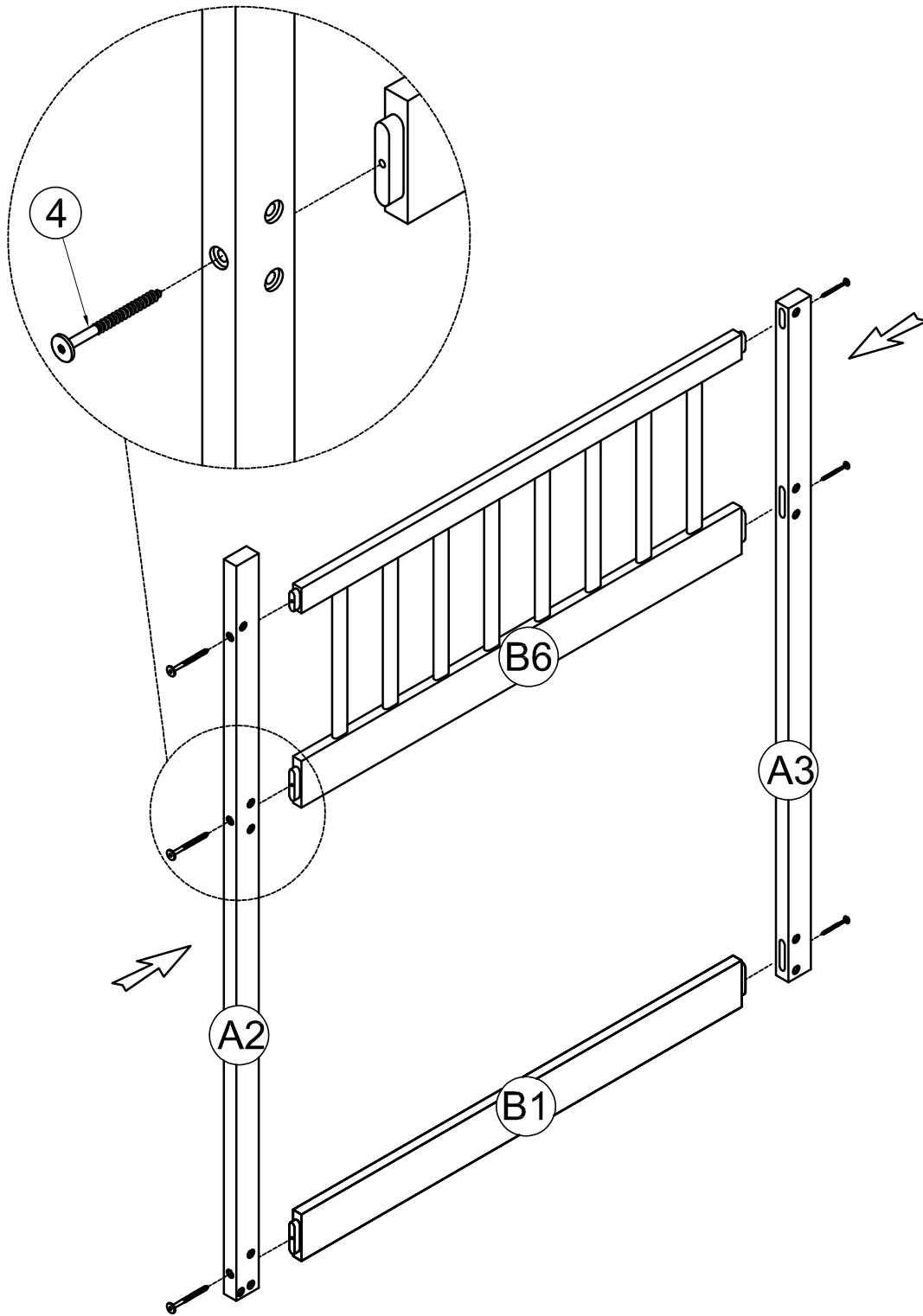

6(pc)

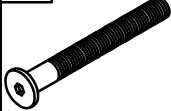

STEP3: Following below illustration.

9		7		2	
18(pcs)		18(pcs)		8(pcs)	

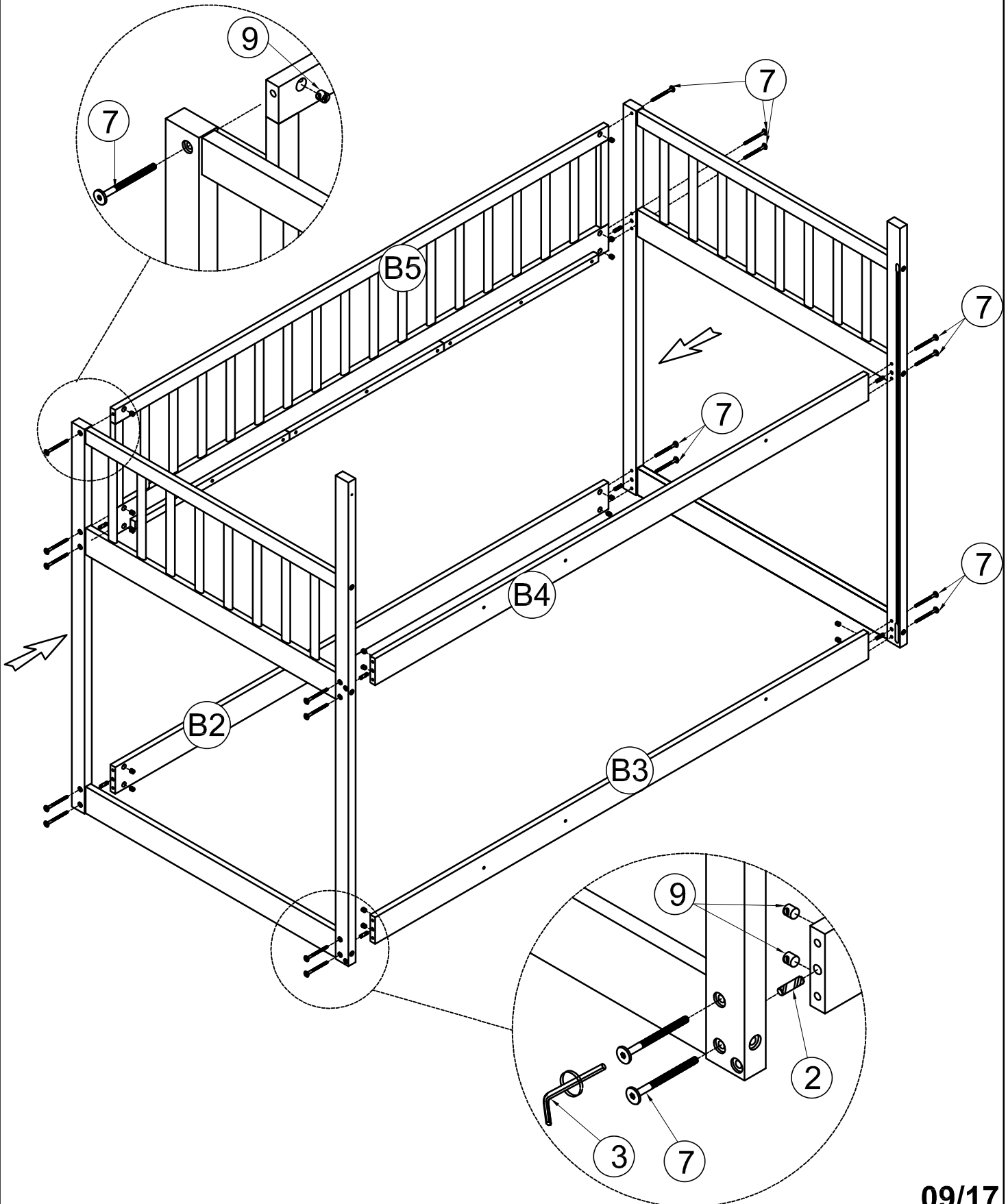

STEP4: Following below illustration.

5



4(pc)

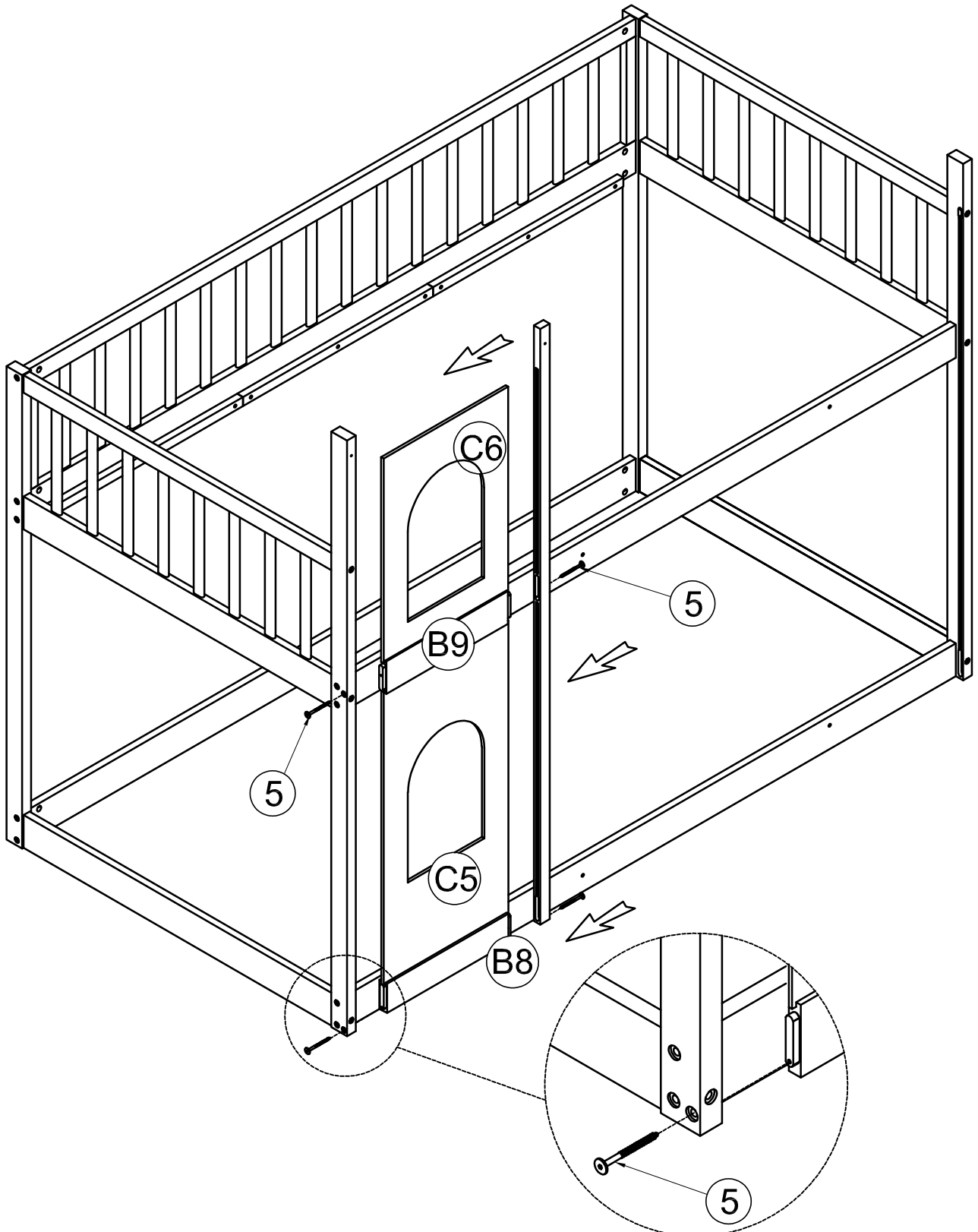

STEP 5: Following below illustration.



5

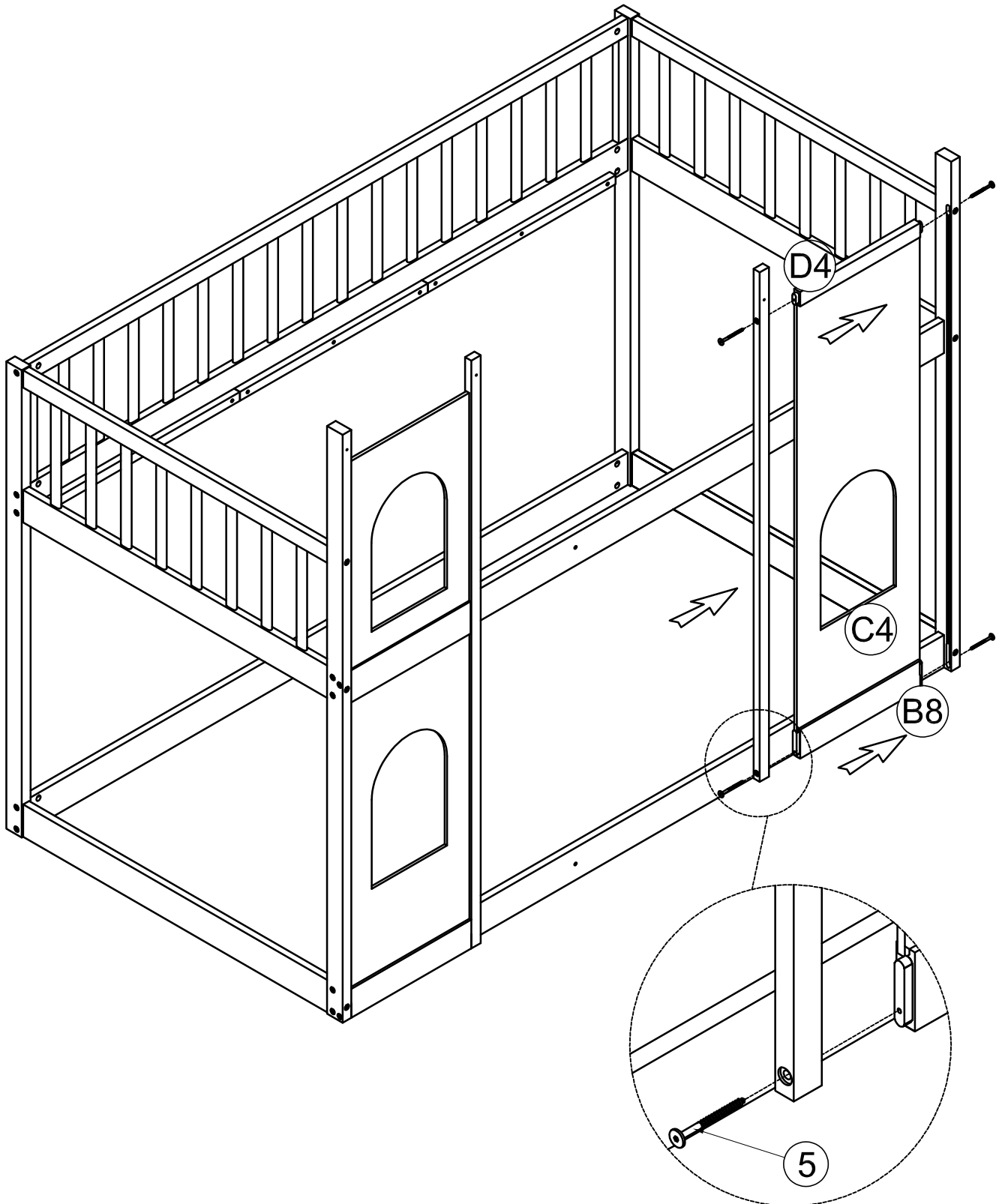

4(pc)



STEP6: Following below illustration.

5	2
	
6(pc)	12(pcs)

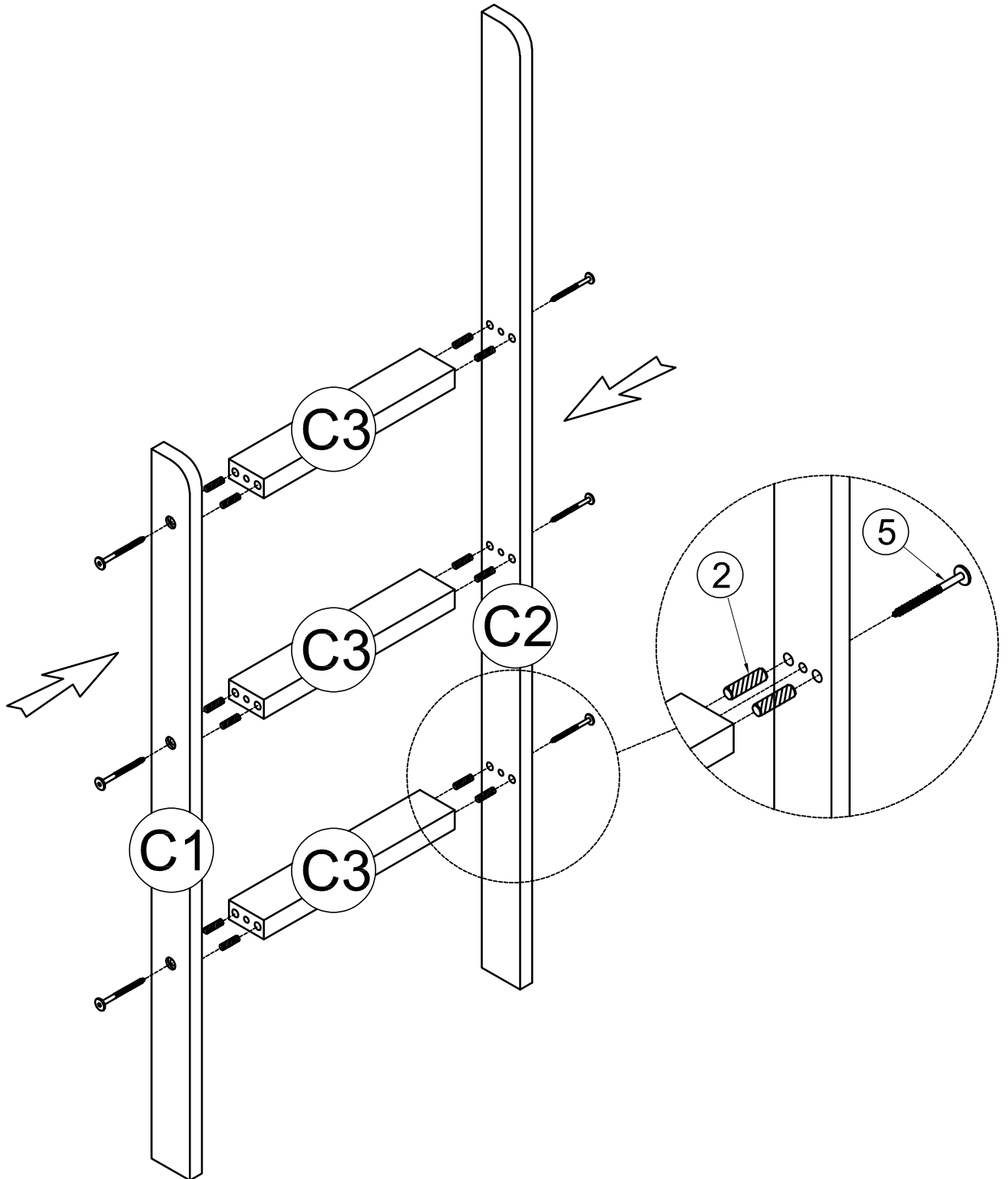

STEP 7: Following below illustration.

8



4(pcs)

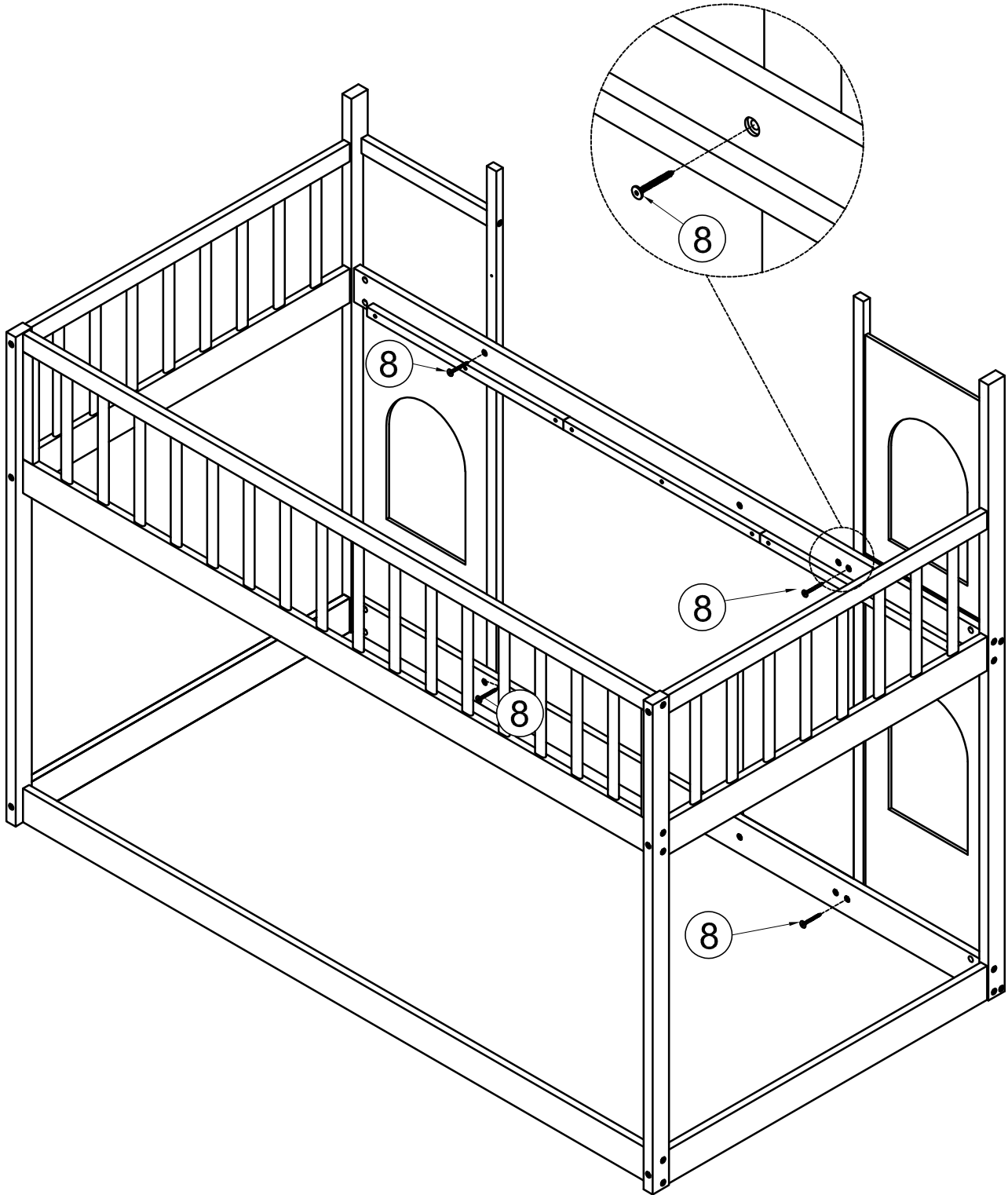

STEP8: Following below illustration.



6

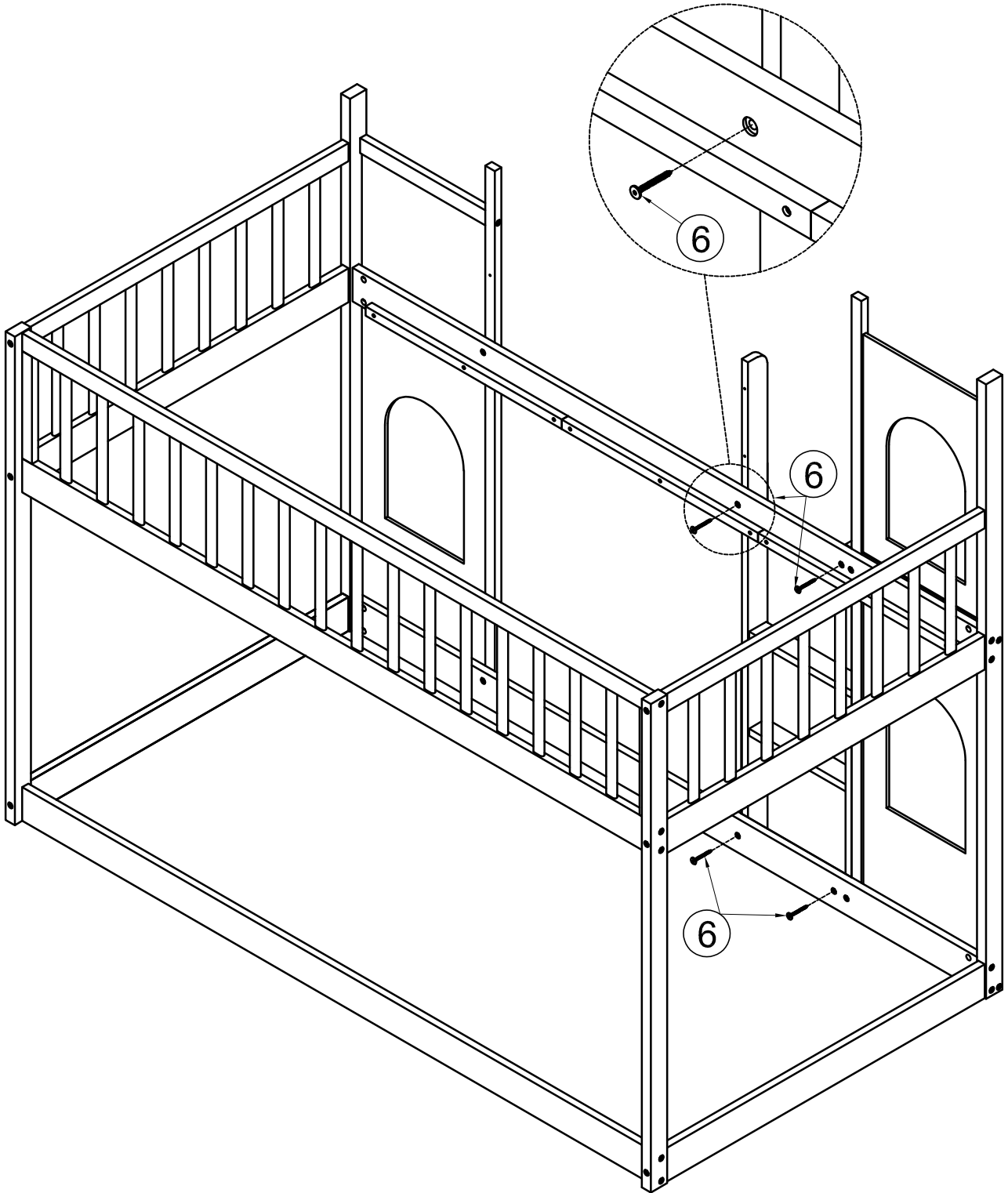

4(pcs)



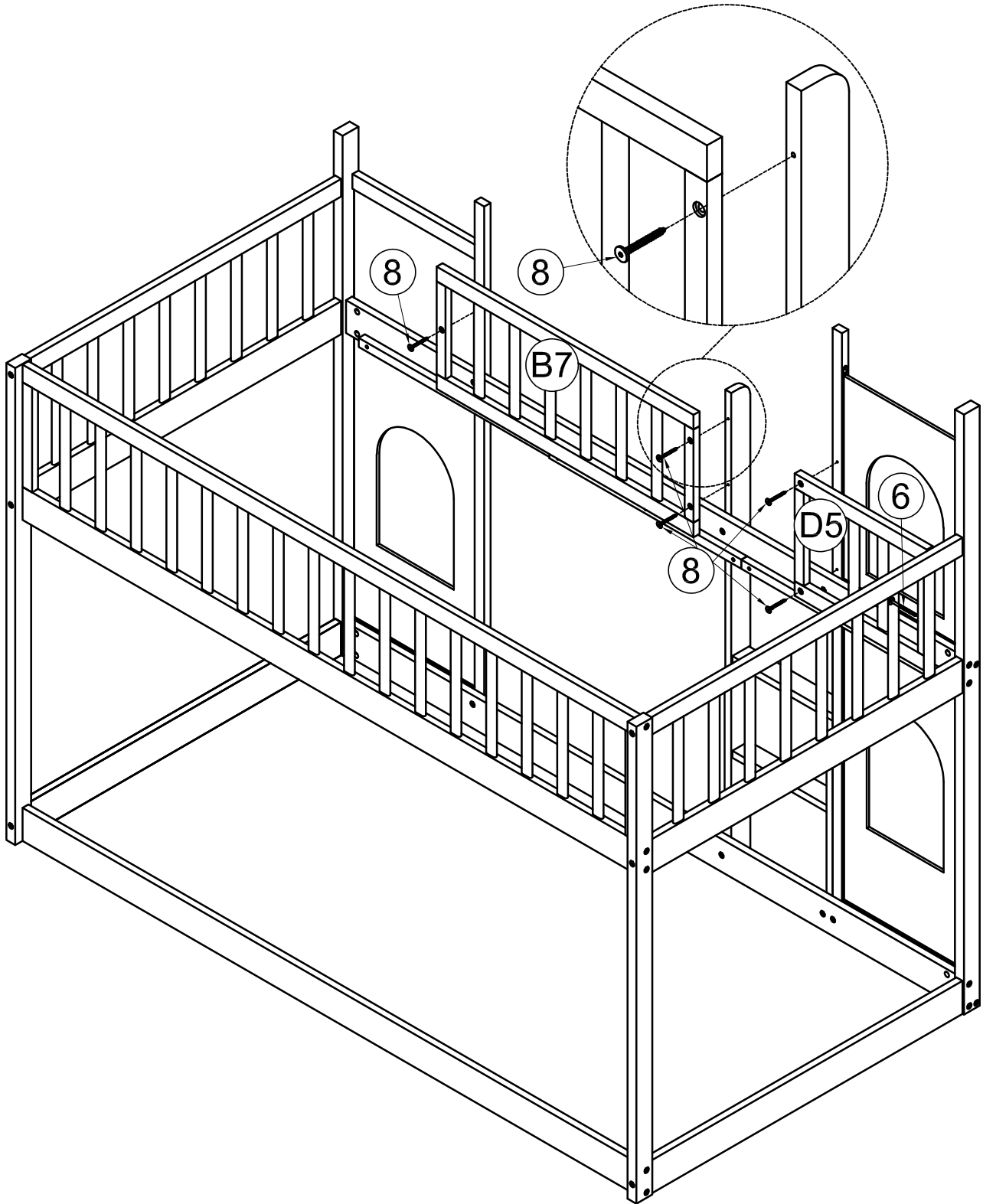

STEP9: Following below illustration.

6	8
	
1(pc)	5(pcs)



STEP10: Following below illustration.

8	1
	
4(pcs)	6(pcs)

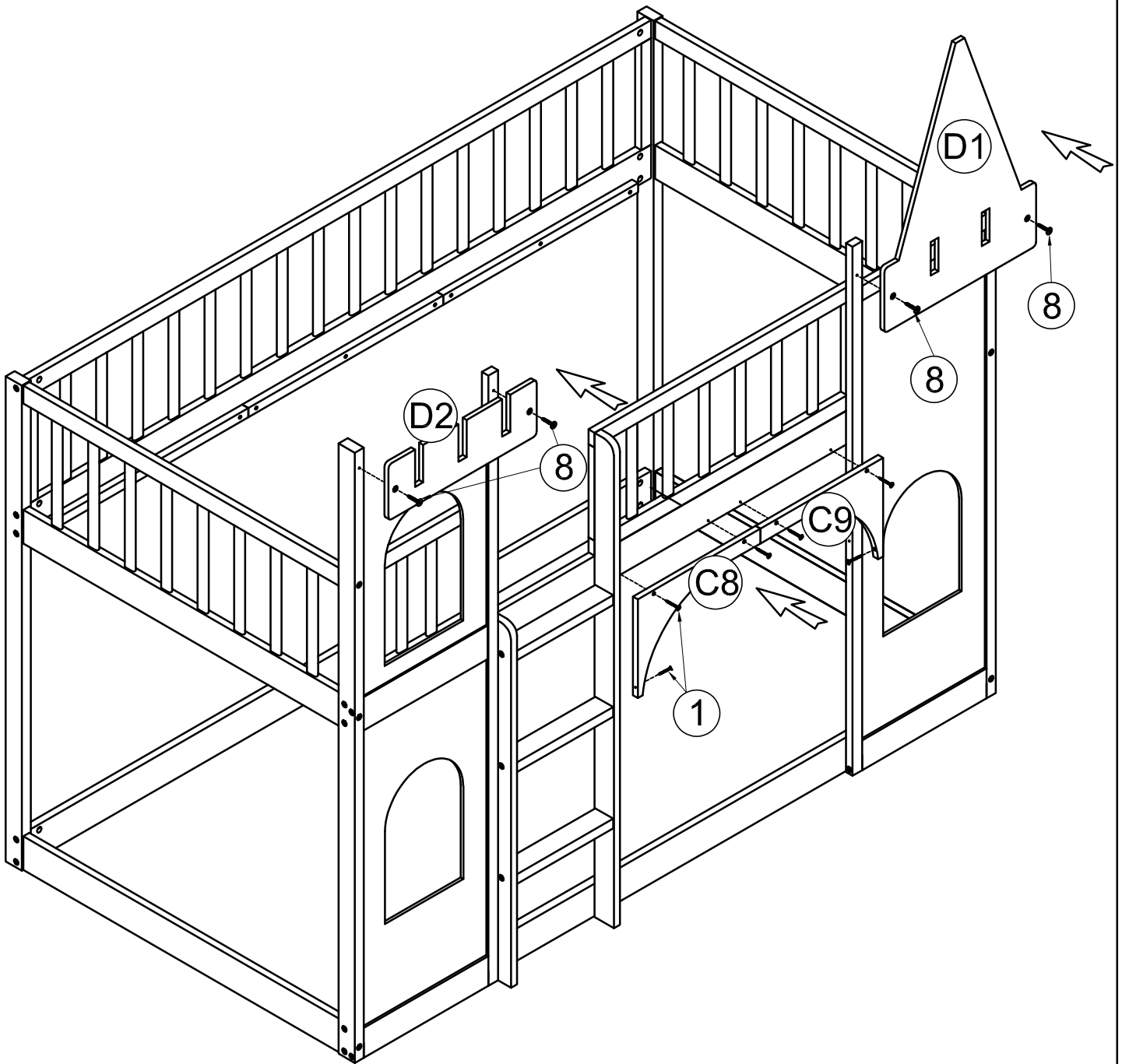

STEP11: Following below illustration.

1



28(pcs)

