

Assembly Instructions

Instrucciones De Ensamblaje



LEA ESTAS INSTRUCCIONES ANTES DE
UTILIZAR EL PRODUCTO
MESA DE FUTBOLITO
MODELO: SOC054_118M
CONTENIDO: 1 MESA DE FUTBOL DESARMADA CON
ACCESORIOS
EDAD RECOMENDADA: 12 AÑOS EN ADELANTE
HECHO EN CHINA
IMPORTADO POR: COMERCIALIZADORA MÉXICO
AMERICANA, S. DE R.L. DE C.V. AV. NEXTENGO NO. 78,
COL. SANTA CRUZ ACAYUCAN, AZCAPOTZALCO, CIUDAD
DE MÉXICO, MÉXICO, C.P. 02770.
TEL. 58991200 EXT. 31616

TOOLS REQUIRED

Phillips Screwdriver
Standard (Flat Head
Screwdriver)
Allen Key

- **Not Included**
- **Not Included**
- **Included**



Power Tools: **Set to Low Torque**
Herramientas eléctricas: **Bajo par**



High Torque: **Over Tightened**
Alto par: **más estrictas**

HERRAMIENTAS NECESARIAS

Destornillador Phillips
Destornillador de
Cabeza Plana
Llave Allen

- **No incluido**
- **No incluido**
- **Incluido**



RECOMMENDED

Electric Screwdrivers may be helpful during assembly; however, please set a low torque and use extreme caution.

RECOMENDADO



Los destornilladores eléctricos pueden ser de gran ayuda durante el ensamblado; sin embargo, por favor ajuste el par de giro bajo y sea extremadamente precavido.

IMPORTANT NOTICE!

1. This product is intended for INDOOR use only.
2. Please do not sit, climb or lean on the product.
3. Please do not drag the product when moving it in order to avoid damaging the legs.
4. Please only use spray furniture polish to clean the exterior surfaces of the product.
5. This is not a child's toy, adult supervision is required for children playing this game.

¡AVISO IMPORTANTE!

1. Este producto está destinado únicamente para el uso INTERIOR.
2. NO se siente, suba o apoye sobre el producto.
3. NO arrastre el producto cuando lo mueva para evitar el daño a las patas.
4. Solo use la cera espray de muebles para limpiar las superficies exteriores del producto.
5. Este producto no es un juguete de niños; la supervisión de adultos es necesaria cuando los niños hagan uso de este juego.



At least 2 adults needed
Se necesitan al menos 2 adultos



No Children in Assembly Area
Los niños no deben estar en el área de ensamblaje



Keep away from pets in assembly area
Mantenga a los animales domésticos alejados



Do not use or keep product outdoors. For indoor use only. No wet/humid conditions.

No use ni guarde el producto en el exterior. Únicamente para uso en interiores. Mantenga el producto libre de condiciones húmedas o mojadas.

WARNING







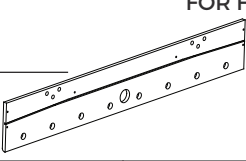
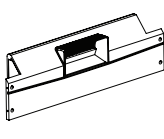
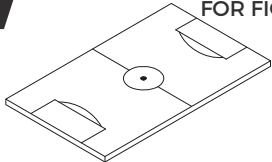
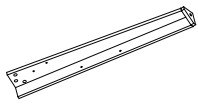
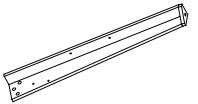
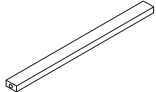
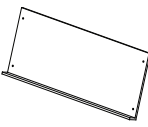
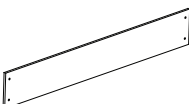
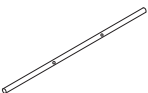
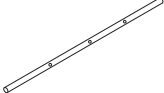
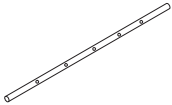

Adult Assembly Required.
CHOKING HAZARD - This item contains small parts or / and small balls. Not suitable for children under 3 years.

ADVERTENCIA

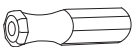
El ensamblaje debe ser realizado por un adulto.
PELIGRO DE ASFIXIA - Este artículo contiene piezas pequeñas y / o pequeñas bolas. No apto para menores de 3 años.

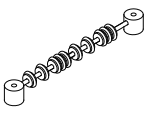
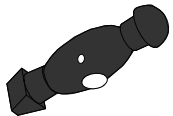
PARTS IDENTIFIER

IDENTIFICADOR DE PIEZAS

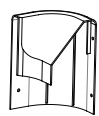
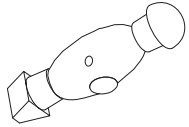
PART NUMBER NÚMERO DE PIEZA		1		FOR FIG. 1		FIG NUMBER NÚMERO DE FIG	
PART PIEZA				x2		QUANTITY CANTIDAD	
PART NAME		Side Apron	Delantal Lateral			PART NAME	
2	FOR FIG. 1, 2	3	FOR FIG. 1	4	FOR FIG. 3	5	FOR FIG. 3
							
x2		x1		x2		x2	
End Apron	Delantal Final	Playfield	Campo de Juego	Left Leg	Pierna Izda	Right Leg	Pierna Dcha
6	FOR FIG. 2	7	FOR FIG. 5	8	FOR FIG. 4	9	FOR FIG. 8
							
x2		x2		x2		x2	
Support Brace	Abrazadera de Soporte	End Leg Panel	Panel de Pierna Final	Side Leg Panel	Panel de Pierna Lateral	2-Hole Rod	Barra de 2 Agujeros
10	FOR FIG. 8	11	FOR FIG. 8	12	FOR FIG. 8	13	FOR FIG. 8
							
x4		x2		x16		x16	
3-Hole Rod	Barra de 3 Agujeros	5-Hole Rod	Barra de 5 Agujeros	Rod Washer	Arandela de Barra	Foam Bumper	Bómpfer de Espuma
14	FOR FIG. 9	15	FOR FIG. 9	16	FOR FIG. 7	17	FOR FIG. 8
							
x8		x8		x2		x11	
Handle	Manija	Rod End Cap	Gorra de Barra Final	Scorer	Marcador	Player - Black	Jugador - Negro
18	FOR FIG. 8	19	FOR FIG. 4	20	FOR FIG. 6	21	FOR FIG. 6
							
x4		x4		x2		x2	
Stop Ring	Anillo de Parada	Leg Leveler	Nivelador de Pierna	Left Apron Corner	Córner de Delantal Izquierda	Right Apron Corner	Córner de Delantal Derecha
22	FOR FIG. 8						
							
x11							
Player - White	Jugador - Blanco						







ACCESSORIES

ACCESORIOS

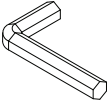
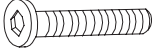
23	
	
x2	
Soccer Ball	Pelota de Fútbol

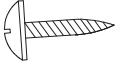

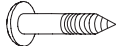
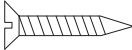
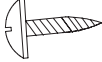

HARDWARE

HARDWARE

A1		x1	A2		x12	A3		x12	A4		x4
Allen Key	Llave Allen		M6x28mm Bolt	Tornillo de Pierna M6x28mm		M6 Washer	Arandela M6		4x35mm Round Head Screw	Tornillo de Cabeza Redonda 4x35mm	
A5		FOR FIG. 6	A6		FOR FIG. 8	A7		FOR FIG. 1, 2, 7	A8		FOR FIG. 4, 5
		x16			x22			x12			x16
4x12mm Screw	Tornillo 4x12mm		3x23mm Screw	Tornillo 3x23mm		4x35mm Flat Head Screw	Tornillo de Cabeza Plana 4x35mm		4x15mm Screw	Tornillo 4x15mm	
A9		FOR FIG. 8									
		x8									
3x8mm Screw	Tornillo 3x8mm										

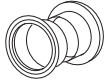
PRE-INSTALLED PARTS

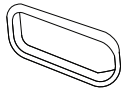
PIEZAS PREINSTALADAS

P1		x16	P2		x2	P3		x16	P4		x2
Plastic Rod Bushing	Cojinete de Barra Plástica		Plastic Ball Entry Rim	Llanta de Entrada de Pelota Plástica		T - Nut	T - Tuerca		Ball Return Cover	Cubierta de Retorno de Bola	
P5		FOR FIG. 1, 2									
		x2									
Goal Box	Caja de Gol										

IMPORTANT NOTICE!
Do Not Return This Product To The Store.

¡AVISO IMPORTANTE!
NO DEVUELVA ESTE PRODUCTO A SU LOCAL DE VENTA.

Please Keep Your Instructions! Your Model number is necessary should you need to contact us. Please read through this instruction manual book to familiarize yourself with all parts and assembly steps. Kindly refer to the parts list below and be sure that all parts have been included.

¡Por favor guarde las instrucciones! Es necesario el número de modelo para contactar con nosotros. Por favor léa las instrucciones para poder familiarizarse con las piezas y los pasos para armar. Corrobore que todas las piezas que aparecen en el "Lista de Partes" se encuentren en el paquete.

BEFORE ASSEMBLY

ANTES DE MONTAR

1. Find a clean, level place to begin the assembly of your Product.
2. Verify that you have all listed parts as shown on the part list pages.

1. Encuentre un lugar limpio y nivelado para comenzar el ensamblaje del producto.
2. Compruebe que tenga todas las piezas que se muestran en la lista de piezas.

ASSEMBLY

MONTAJE

FIG. 1

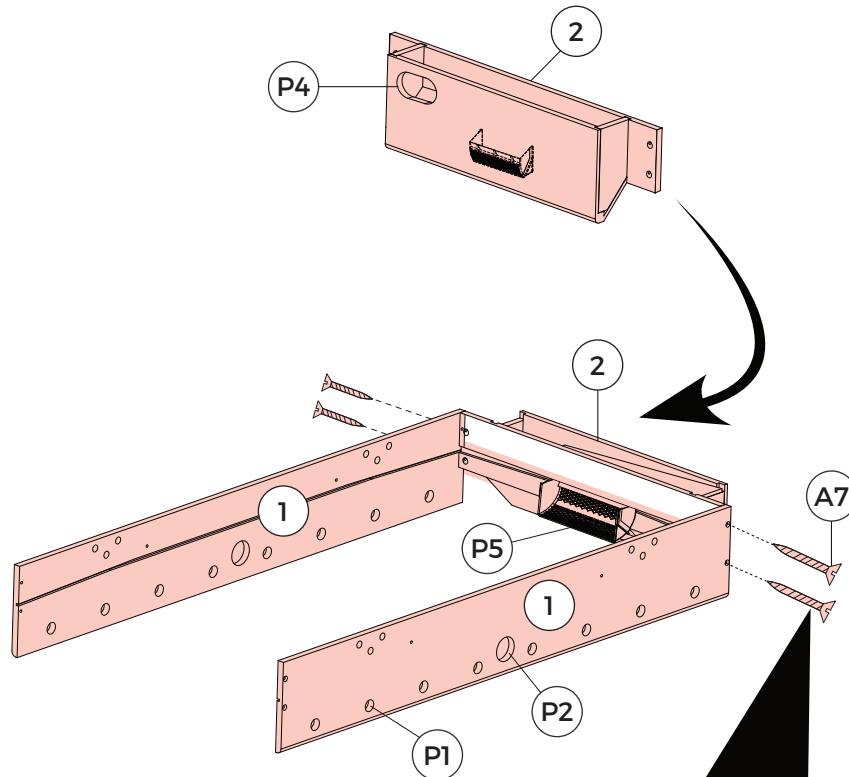
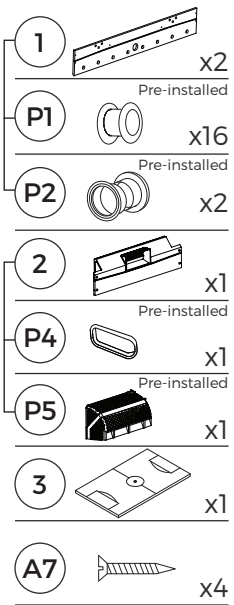

Note: Do not tighten the screws at this step.
/ Nota: No apretes los Tornillos en este paso.

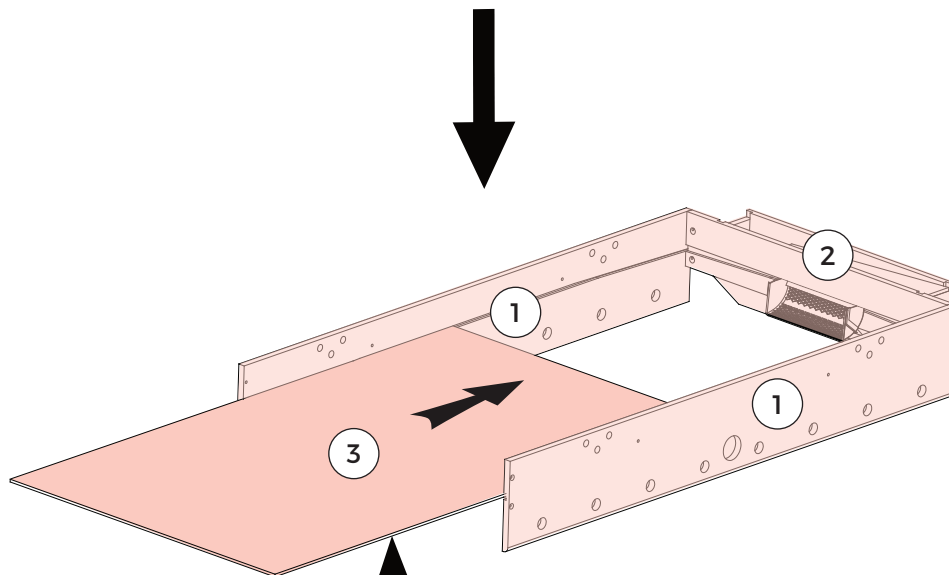







Note: Slide the Playfield (#3), with the graphics facing down, into the grooves of the Side Aprons (#1).

/ Nota: Deslice el Campo de Juego (#3), con el gráfico hacia abajo, dentro de los guantes de Delantales Lateral (#1).

ASSEMBLY

MONTAJE

FIG. 2

- | | | |
|----|---|----|
| 2 |  | x1 |
| | Pre-installed | |
| P4 |  | x1 |
| | Pre-installed | |
| P5 |  | x1 |
| 6 |  | x2 |
| A4 |  | x4 |
| A7 |  | x4 |

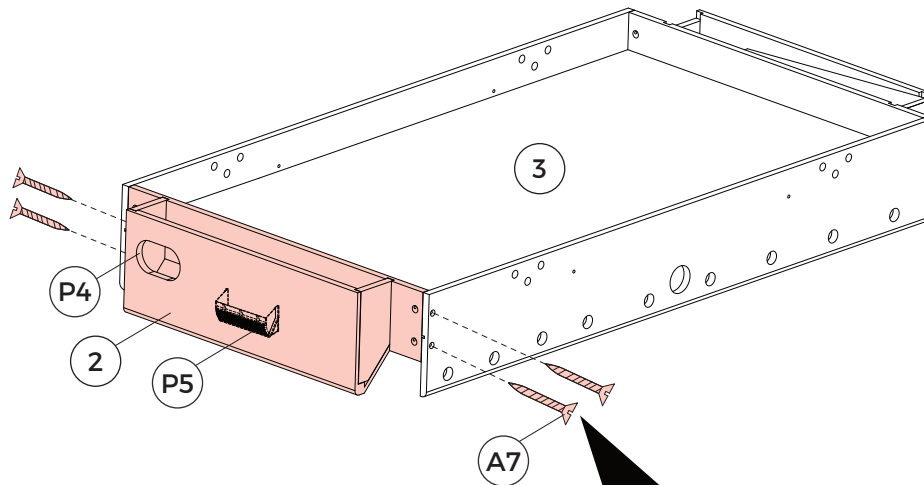

Note: After this step, tighten Screw (#A7).



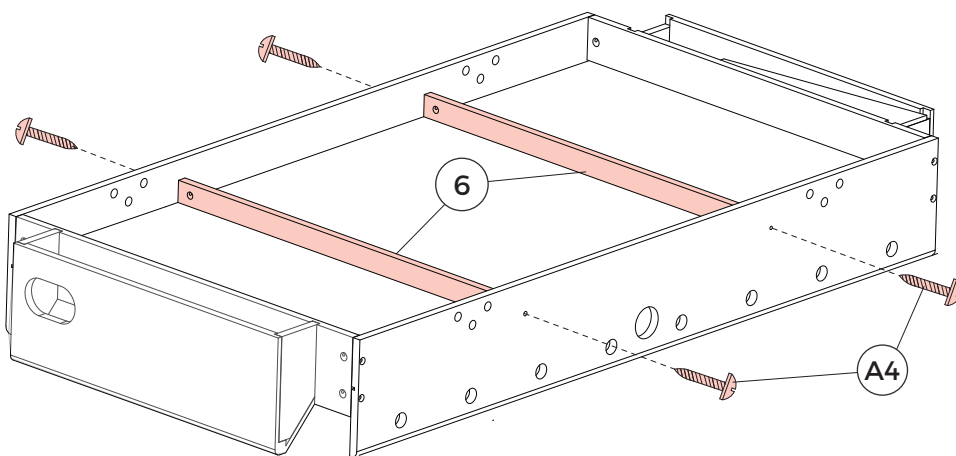

/ Nota: Luego de este paso, apretar el tornillo (#A7).



ASSEMBLY

MONTAJE

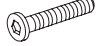

FIG. 3

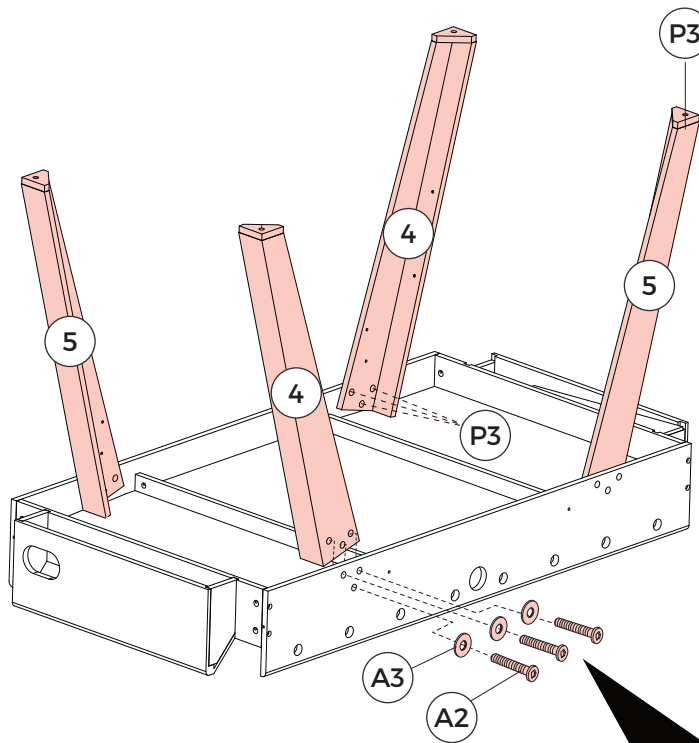
- 4  x2
- 5  x2
- P3  x16
Pre-installed
- A2  x12
- A3  x12
- A1  x1



Note: DO NOT over tighten bolts.
 / Nota: QUE NO aprietes cerrojos.

FIG. 4

- 8  x2
- 19  x4
- A8  x8

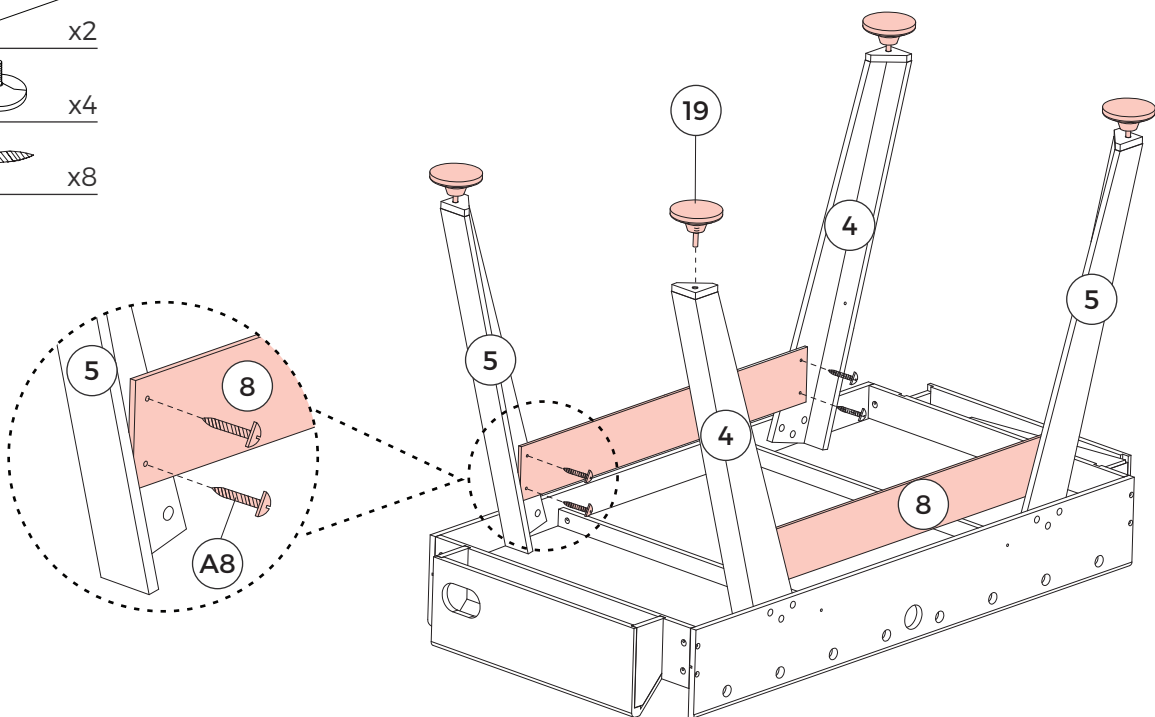

ASSEMBLY

MONTAJE

FIG. 5

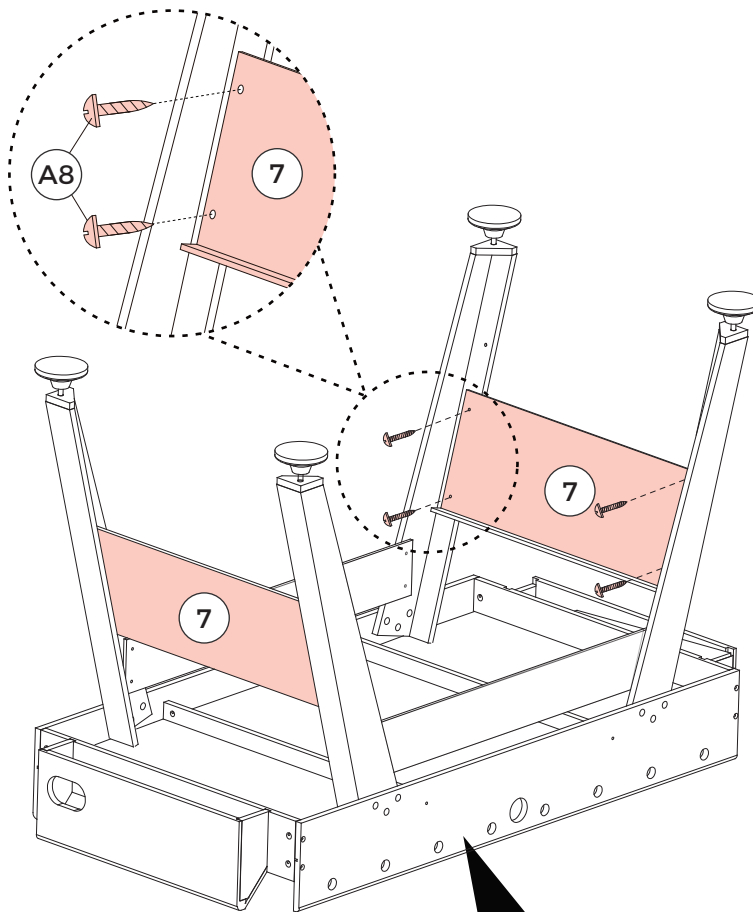
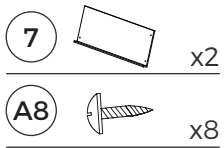

Note: Go back and make sure that all connections are tight.

/ Nota: Vuelva y asegúrese que todas las conexiones están apretadas.

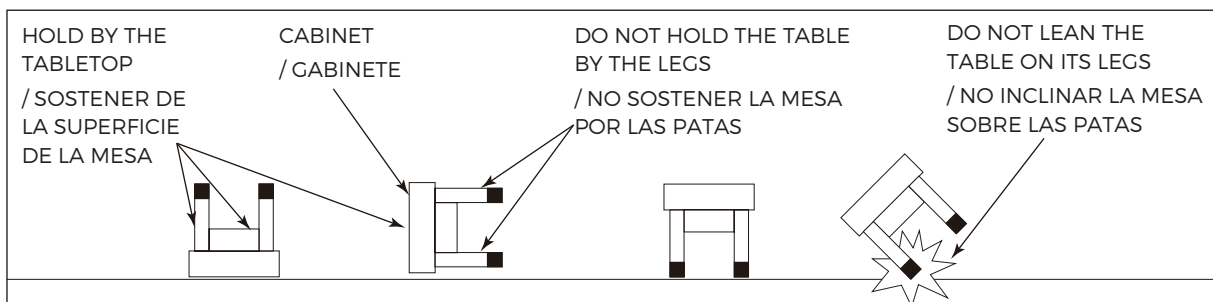

⚠ CAUTION

Two strong adults are recommended to turn over the table as shown.

1. Lift the table off the ground.
2. Turn the table over.
3. Place all four feet on the ground at the same time.

⚠ PRECAUCIÓN



Se recomienda la participación de dos adultos para invertir la mesa como se muestra.

1. Levante la mesa desde el piso.
2. Voltee la mesa.
3. Coloque las cuatro patas en el suelo al mismo tiempo.

ASSEMBLY

MONTAJE

FIG. 6

- 20  x2
- 21  x2
- A5  x16

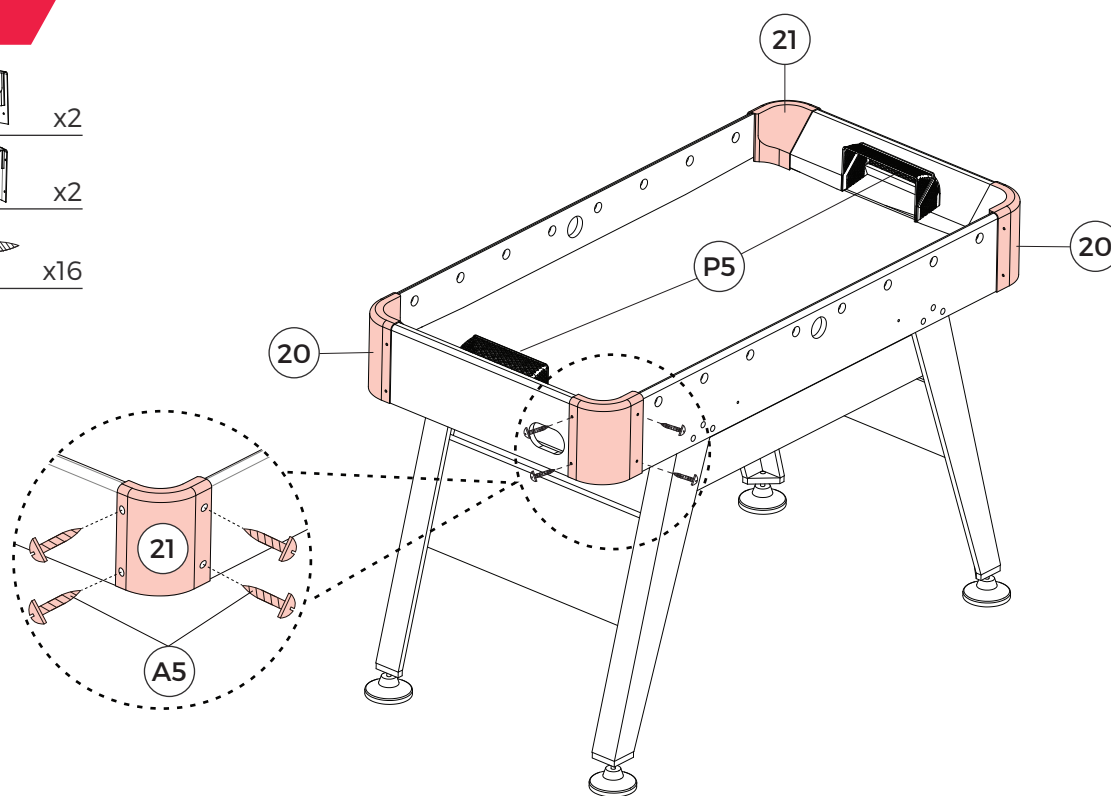

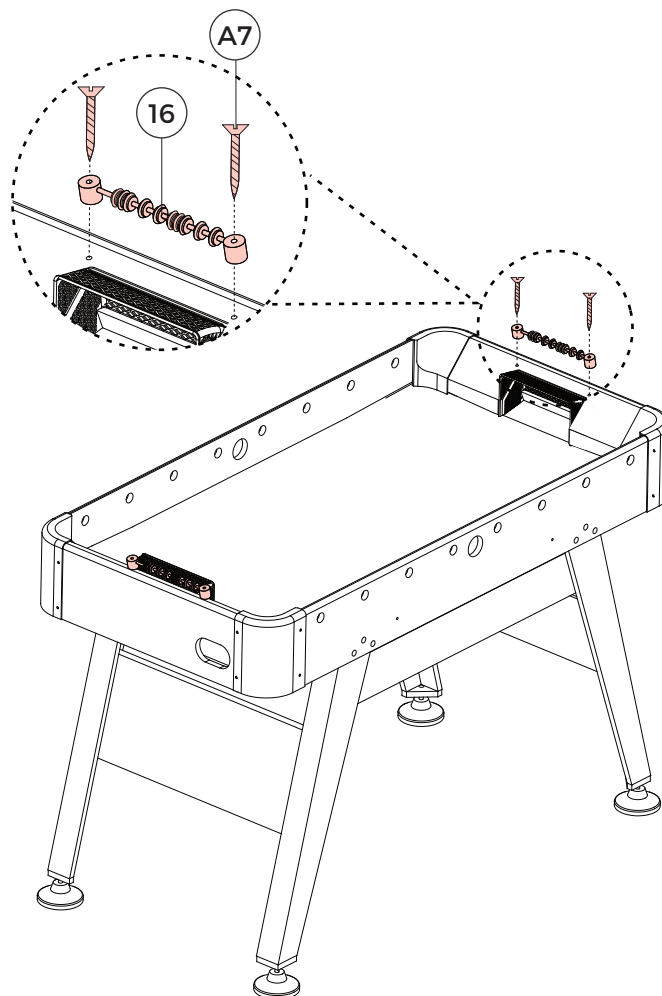

FIG. 7









- 16  x2
- A7  x4

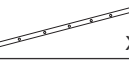

ASSEMBLY

MONTAJE

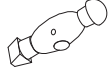
FIG. 8

- 9  x2
- 10  x4
- 11  x2
- 12  x16
- 13  x16
- 17  x11
- 18  x4
- 22  x11
- A6  x22
- A9  x8

Note: The Rods have a hole at the end where their Handles will go.
/ Nota: Las Barras de Jugador hay un agujero en su parte final donde coloque las Manijas.

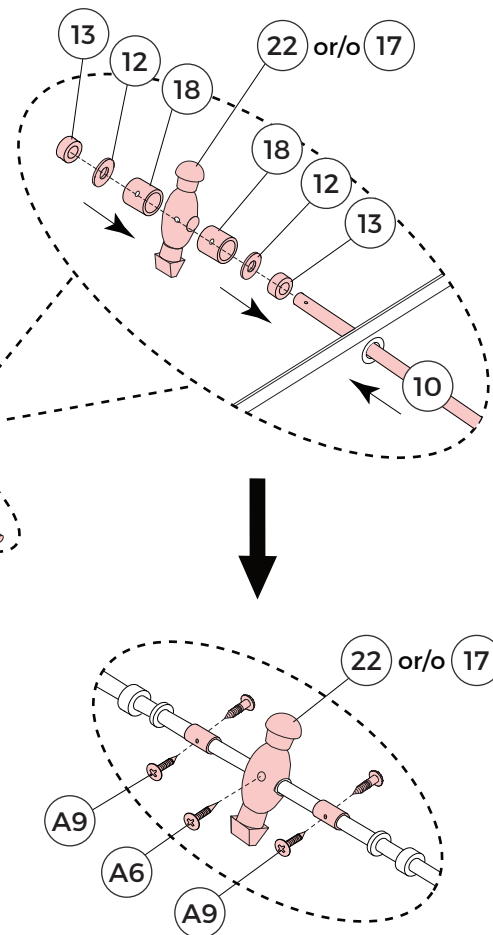
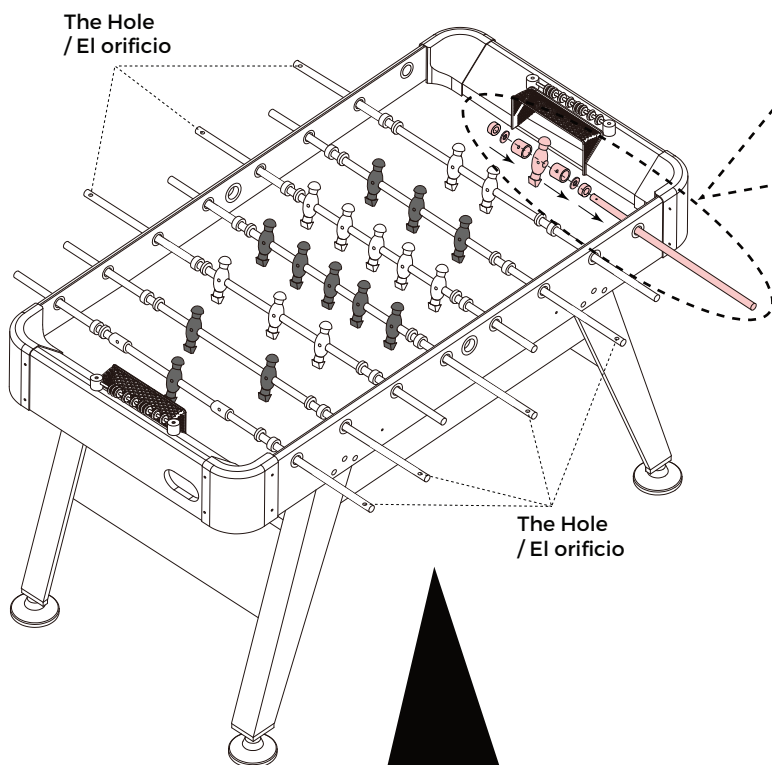
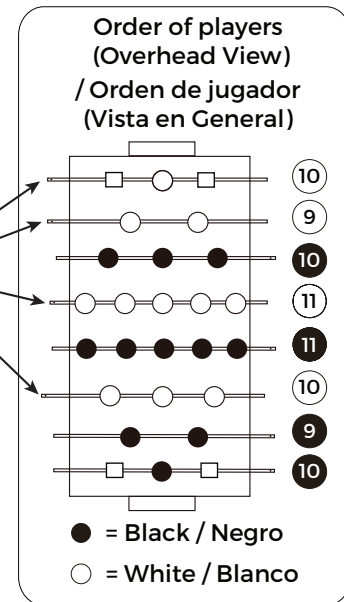

Note: Players of the same team color should have Handles (#14) on the same side, and each team's player should be facing their opponent.
/ Nota: Los jugadores del mismo color de equipo debería tener Manijas (#14) sobre el mismo lado, y los jugadores de cada equipo debería afrontar a su opositor.

ASSEMBLY

MONTAJE

FIG. 9

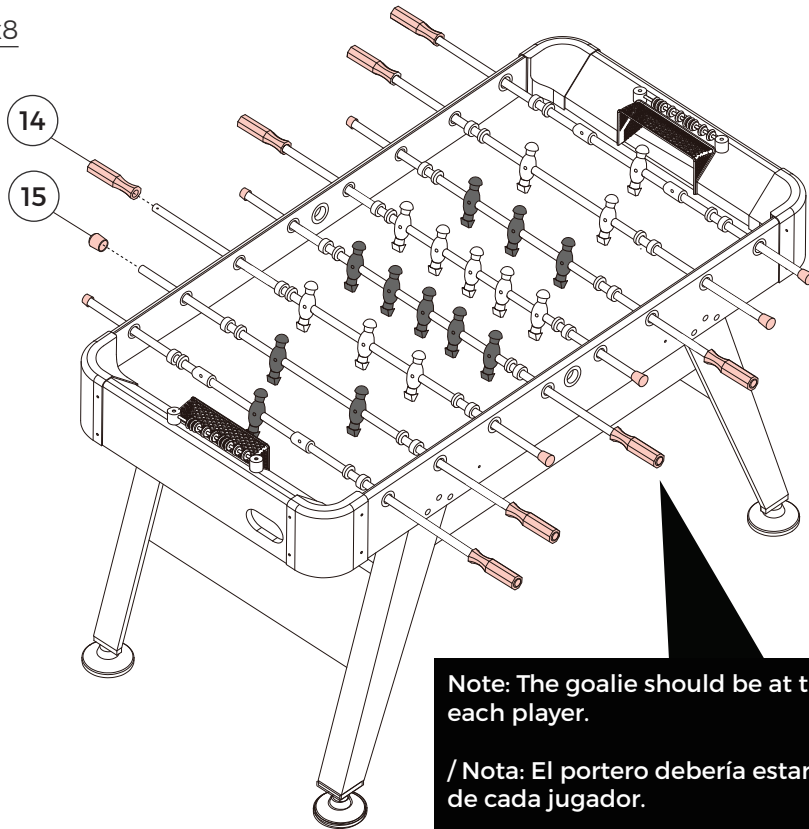
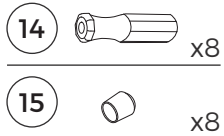



www.medalsports.com