



## Parts and Damage Replacement Procedure

1. Please inspect your purchase immediately.
2. This procedure covers product purchased from an authorized Roundhill Reseller and was received in its originally sealed carton.
3. If you find a part missing or damaged, you have a 30-day window in which to order a replacement part from the date on your purchase receipt.
4. You have 3 ways to do this. You will need a copy of your purchase receipt.
  - a. By Fax: Fax the parts order form below and along with your receipt to 614-878-7918
  - b. By Email: Email the order form and along with your receipt to: [parts@roundhillfurniture.com](mailto:parts@roundhillfurniture.com)
  - c. By Mail: Fill out the parts order form below and along with a copy of your receipt send it to Roundhill furniture parts department 3640 Zane Trace Drive, Columbus OH 43228
5. Once this order is sent in, you will be notified if the part(s) you are requesting can or cannot be shipped within 7-10 business days.

**A COPY OF YOUR PURCHASE RECEIPT OR INVOICE MUST BE ATTACHED TO THIS ORDER FORM.  
NO ORDERS WILL BE PROCESSED WITHOUT PROOF OF PURCHASE.**

NAME: \_\_\_\_\_  
 ADDRESS: \_\_\_\_\_ (No Post Office Boxes)  
 CITY: \_\_\_\_\_ STATE: \_\_\_\_\_ ZIP: \_\_\_\_\_  
 PHONE: \_\_\_\_\_ FAX: \_\_\_\_\_  
 EMAIL: \_\_\_\_\_

### REASON FOR REPLACEMENT/PLEASE CHECK APPROPRIATE BOX.

- Damaged /scratched, cracked, broken, crushed, etc.
- Mechanical malfunction/ drawer glides, swivel mechanisms, lid stays, etc.
- Missing pieces
- Unfinished surface
- Wrong color
- Other



IF MORE THAN ONE MODEL NUMBER IS LISTED ABOVE, PLEASE SPECIFY THE EXACT MODEL NUMBER OF YOUR ITEM IN THE SPACE PROVIDED BELOW.





Model Number	Part Letter Code	Quantity

# Assembly Instruction for BENCH CB5227

**Caution:** Please read instructions thoroughly before unpacking assembly parts. Sharp, exposed staple tips can cause injury, therefore, for your protection, please remove any exposed staples used in packing.

1. We recommend that you should assemble this product with the assistance of another person; this will make assembly easier, and will help to eliminate damage to the product or injury to persons during assembly.
2. Be sure to check all packing materials carefully for small parts that may have come loose inside the carton during shipment.
3. Please do not over tighten screws or bolts.
4. Please Put all parts on a non-abrasive floor before assembly, and follow the assembly steps to assemble your newly purchased product correctly and efficiently.

PART LIST			
No.		PART DESC	Q'TY
A		BENCH SEAT	1
B		BENCH LEG	4

HARDWARE LIST			
No.		HARDWARE DESC	Q'TY
1		ALLEN BOLT (5/16"*2-1/4")	8
2		FLAT WASHER (5/16"*22*1.5mm)	8
3		SPRING WASHER (5/16)	8
4		ALLEN KEY (M5*68mm)	1

**STEP 1**

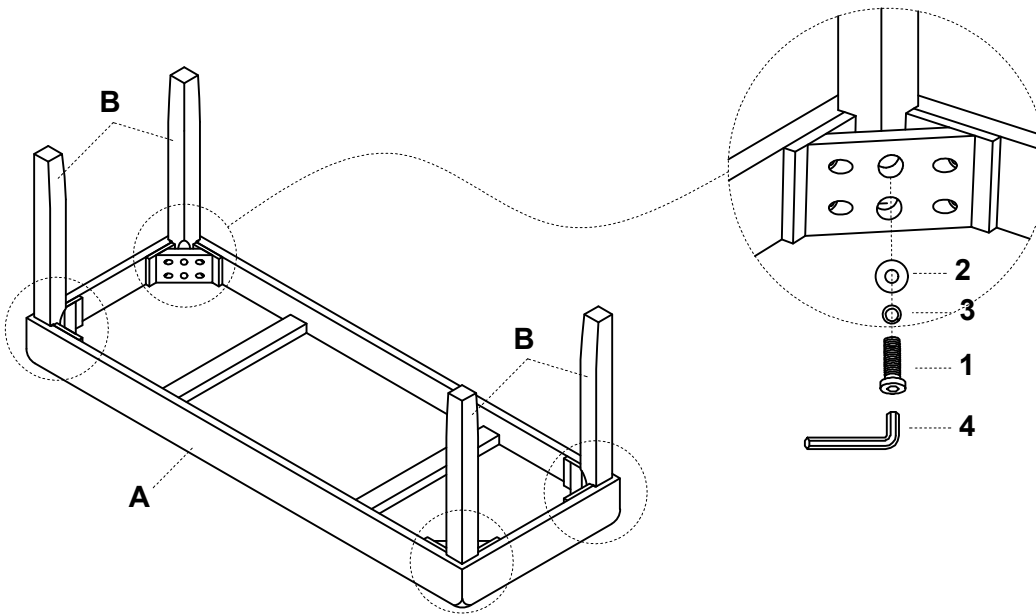

**STEP 2: Completed**

