







Assembly Instruction

2/10

Hardwares



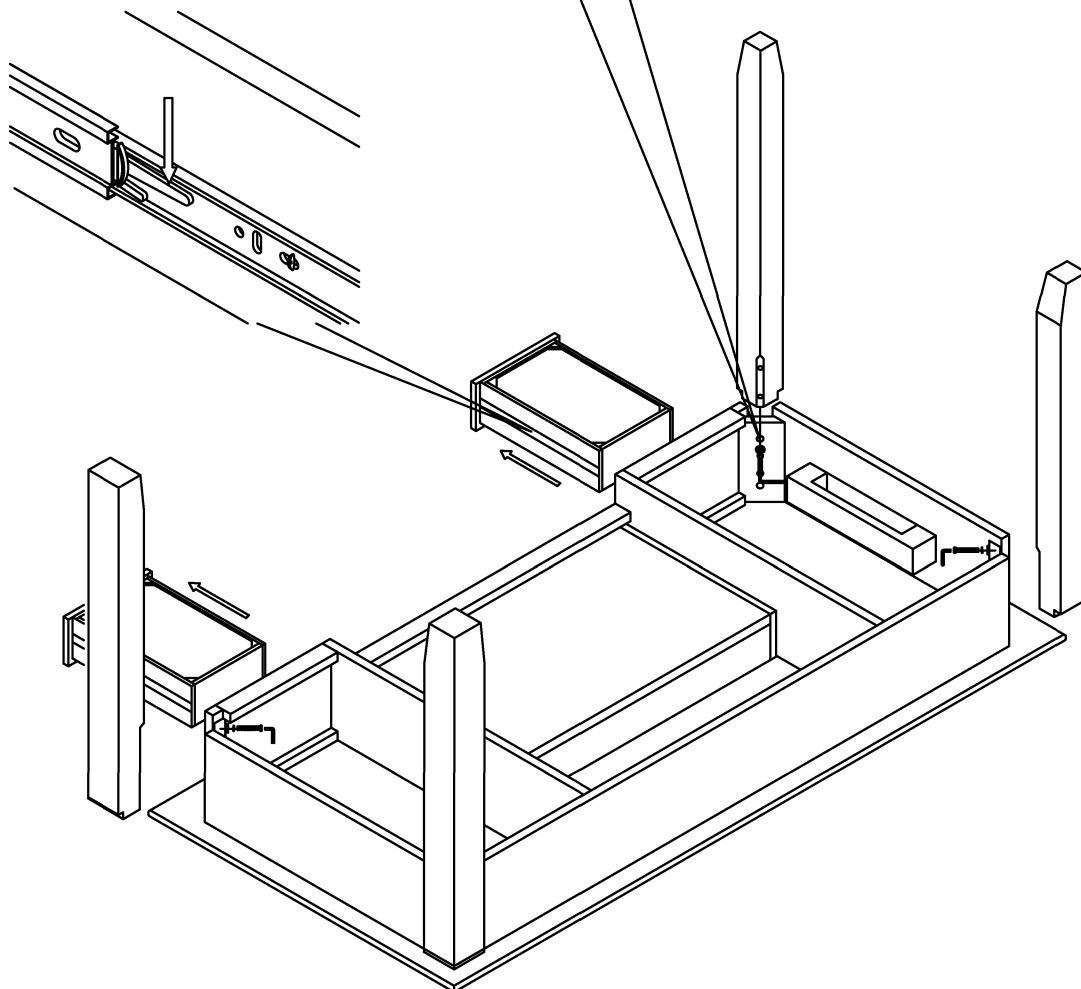
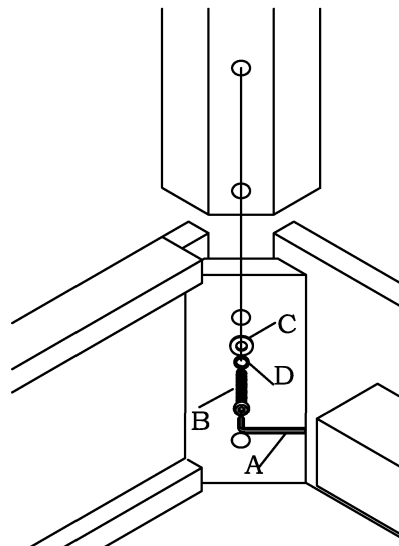



NO	Description	Sketch	Q'TY
A	Allen key		1pc
B	2" Bolt		8pcs
C	Flat washer		8pcs
D	Spring washer		8pcs
E	Wire lid		1pc
	Touch up Pen		1pc



Assembly Instruction

3/10

Hardwares

NO	Description	Sketch	Q'TY
A	Allen key	 5MM	1pc
B	2" Bolt		8pcs
C	Flat washer		8pcs
D	Spring washer		8pcs
E	Wire lid		1pc
	Touch up Pen		1pc

