

FD36UXIW



Product family	Refrigerator
Installation	Free-standing
Category	3 Doors
No-frost system	Yes
Cooling type	Total no-frost - Dual-flow cooling system
Defrost	Automatic
Hinge	Standard
EAN code	8017709344016



Aesthetic



Aesthetics	SPR	Side color	Steel
Color	Stainless steel	Logo	Applied
Material	Steel	Door shelf profile color	Silver
Door stainless steel type	Normal	Drawers profile color	Silver
Handle	External	Glass shelf profile color	Silver
Handle	Fixed	Display	LED
Handle color	Stainless steel	Display position	Internal
Logo color	Stainless steel	Dispenser	Ice and water
Side material	Steel	Water filter	Yes

Refrigerator compartment features



Number of compartments	3	Type of crisper cover	Glass
Compartment types	Low temperature compartment, Fruit and vegetable compartment	No. of lights	4
Type of adjustable shelves	Glass	Refrigerator lighting	Yes
Crisper drawer type	Sliding crisper	Refrigerator lighting	LED
Crisper cover	Yes		

Refrigerator Inner Door

Number of adjustable door shelves 2

No. of bottle shelves 2

Other Refrigerator features



Accessories
MultiFlow

Egg tray
Yes

Fan
Ionizer

Yes
Yes

Freezer features

Number of drawers 2
No. of lights 2

Freezer lighting Yes
Freezer lighting Incandescent light

Other Freezer features

Accessories 1 x ice box

Ice maker Automatic

Other technical features



Display functions

Holiday, Fast-freezing, Sabbath

Fast-freezing button

Yes

Water network connection

Yes

Power-on light

Yes

Temperature alarm

Yes

Door open alarm

Yes

Temperature setting type

Electronic

No. of compressors

1

Refrigerant gas type

R600a

Compressor type

Inverter

Foam agent

Cyclopentane

Performance / Energy Label

Annual energy consumption

Total volume 20.48 cu. ft.

Total volume 20.52 cu. ft.

Noise level 35 dB(A) re 1 pW

Freezer volume 6.75 cu. ft.

Freezer capacity 6.75 cu. ft.

Refrigerator compartment 13.77 cu. ft.

Refrigerator volume 13.77 cu. ft.

Electrical Connection

Electrical connection rating 280 W

Frequency (Hz) 60 Hz







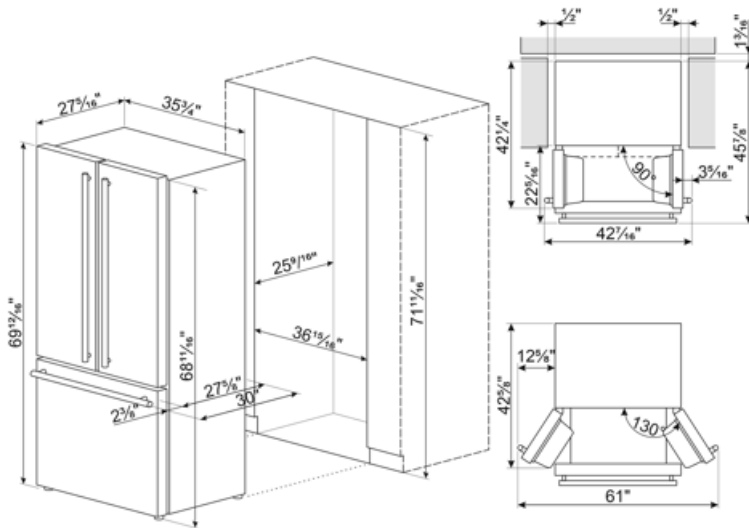



Current	2,7 A	Power cord length	84 5/8 "
Voltage (V)	120 V	Plug	(B) NEMA 5-15P

Logistic Information

Width	35 3/4 "	Built-in niche height	71 11/16 "
Built-in niche width	36 15/16 "	Width with doors open at 90°	41 11/16 "
Depth without handle	26 13/16 "	Product depth (handle included)	29 "
Built-in niche depth	25 "	Depth with door open at 90°	42 1/4 "
Height	69 3/4 "	Spacer depth	0 13/16 "



Symbols glossary

	Smeg Active Ion system improves the quality of the air inside the cell. Thanks to the generation of negatively charged ions released inside the fridge Active Ion system neutralizes unpleasant dust.		The automatic defrost system works by automatically defrosting at regular intervals eliminating the need to defrost altogether.
	LED display: to show programmes, functions and options selected and the time to the end of the cycle.		Ventilated: Forced distribution of cold air in the refrigerator compartment, which allows even temperature distribution within the fridge.
	Fast freezing: The fast freezing function brings the temperature of the compartment down when activated a few hours prior to usage.		Power saving mode: The power saving mode allows you to disable the refrigerator and keep the freezer working.
	LED interior lighting: is a more energy efficient and long lasting way of illuminating the interior of the appliance.		Inverter technology: The evolution of Smeg's driers towards more intelligent and environmentally sustainable models has led to the choice of using Inverter technology with heat pumps, which reduces significantly energy consumption.
	Air plus: keeps food fresher for longer.		Sabbath: This function allows you to cook food during the Sabbath, the Holiday of rest in the Jewish religion, respecting the precepts.