

ASSEMBLY INSTRUCTIONS

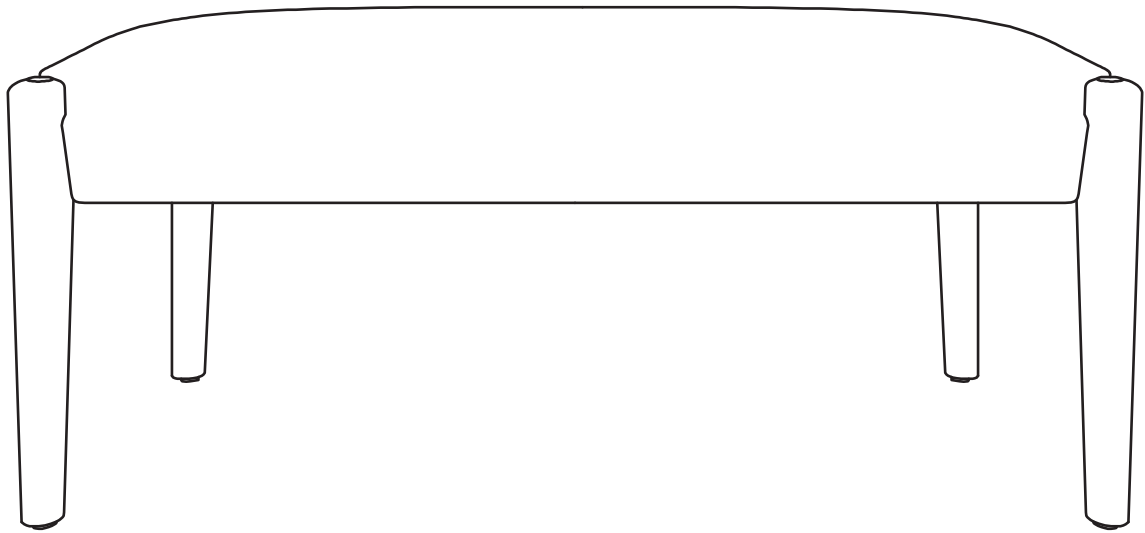

WARNING

 Please read the instructions carefully and follow the assembly steps.

Do not tighten bolts or screws completely until all hardware is lined up and inserted into the holes.

Do not over-tighten screws and bolts to avoid stripping the hardware or cracking the item.

Assemble your item on a flat, carpeted area, with plenty of space to work. This will prevent damage and scratches to your floors or the item while you're assembling the product.

Keep all components and packaging out of reach of children or animals to avoid risk of choking or suffocation.

ASSEMBLY PARTS AND TOOL

BEFORE YOU GET STARTED. A FEW POINTERS:

 Please open the Seat Cushion bottom and take out all accessories before installation.

 Please use the included wrench instead of an ELECTRIC HAND DRILL in case of damage to the chair leg.

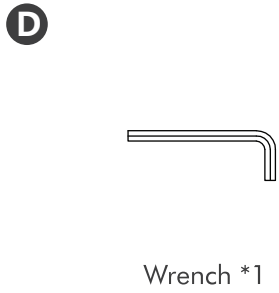
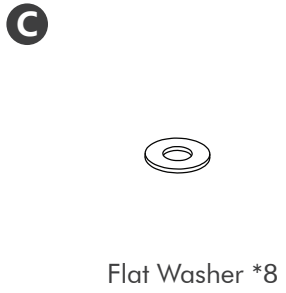
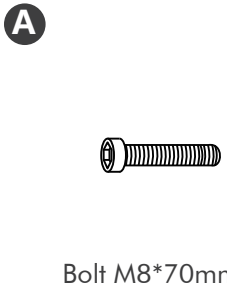
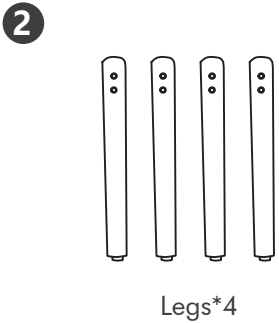
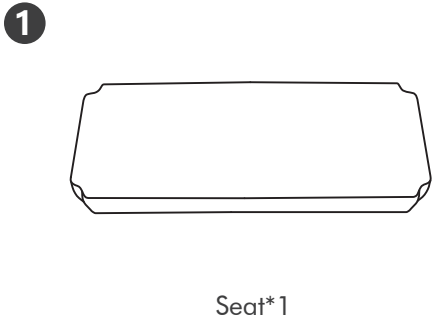

STEP 1:

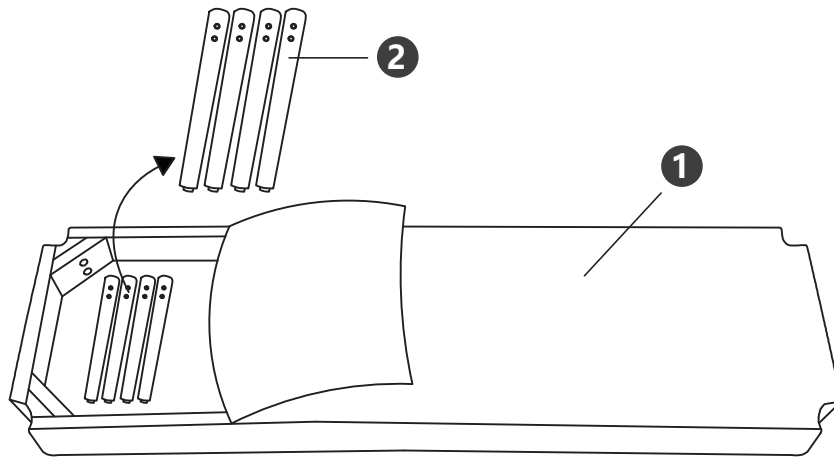

STEP 2:

1

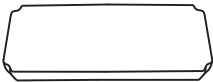

Seat*1

2

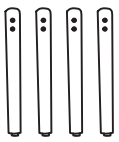

Legs*4

A



Bolt M8*70mm *8

B



Spring Washer *8

C



Flat Washer *8

D



Wrench *1

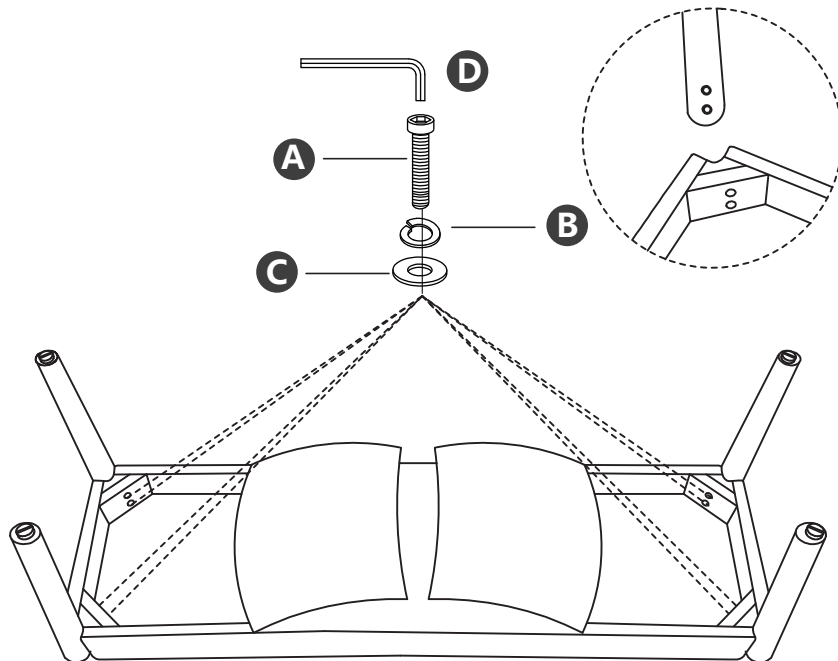

STEP 3:

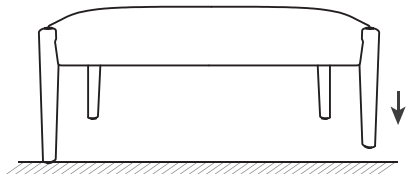
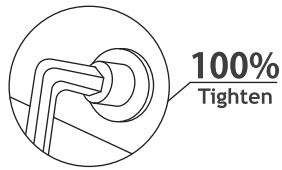
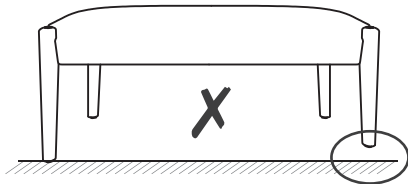

Put pressure on the seat.
(About 44lbs/20kg)

1. Place the chair on a flat surface and apply pressure to the seat. Firstly tighten the back legs and finally the front legs. Make sure all bolts are fully tightened before using the chair.

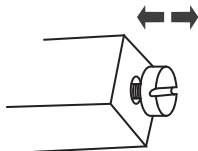
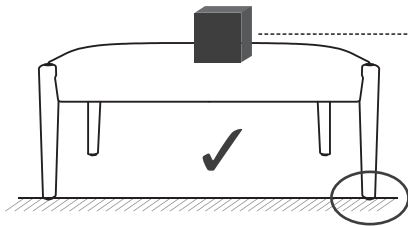

2. If the legs are uneven, you can also adjust the foot pegs at the bottom of the legs to improve balance.

STEP 4:

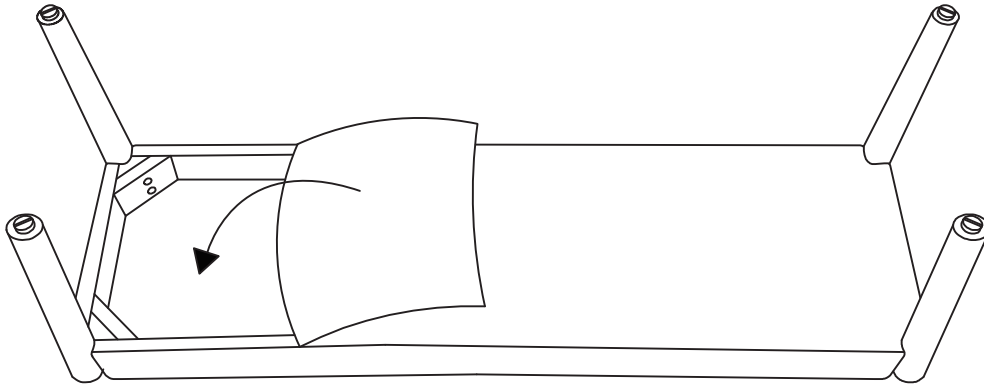

STEP 5:



Your bench assembly is complete!

CARING FOR YOUR ITEM

Indoor use only

Not contract grade.

Clean using a non-abrasive cloth and a mild cleaner.

Never use harsh chemicals, as they could damage the finish or integrity of the item.