

ASSEMBLY INSTRUCTIONS

TOOLS REQUIRED



Allen Wrench

(Included)

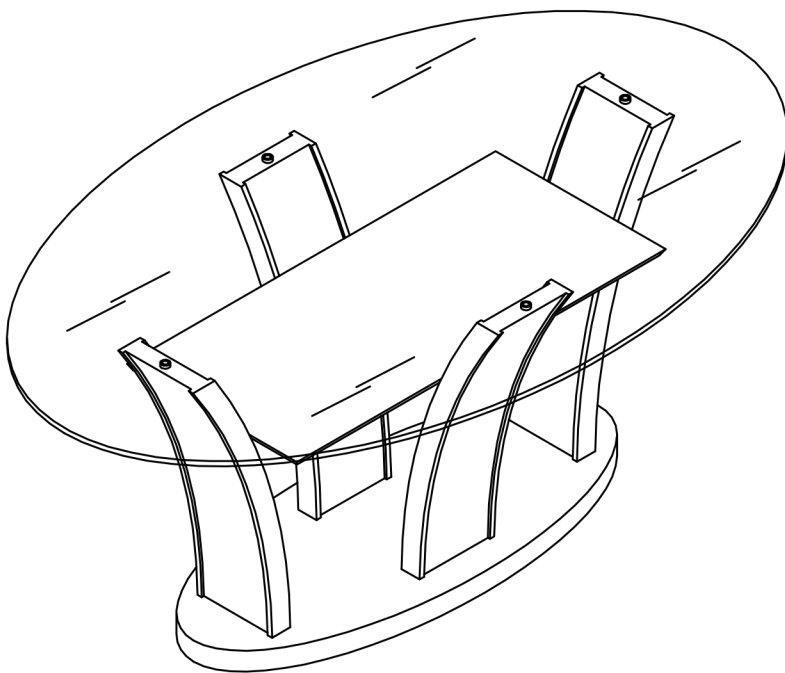

2 - Persons
Recommended

ASSEMBLY RATING



EASY —————> DIFFICULT

The Assembly Rating is a 5-point system showing the level of effort needed to assemble a specific product.



CHECK BEFORE STARTING

Are you missing anything?

Double-check all parts, hardware and accessories listed on Page 6 are accounted for.

Check out our Quick Tips!

We recommend reviewing the pre-assembly handouts. Even experts need a refresher now and then!

Should we send any replacements?

Are there any irregularities or flaws in the parts? We can send replacements!

Prep Time!

Please review the assembly instructions and all diagrams prior to assembling. Set up your workspace by laying the parts and hardware out separately, then begin!

PRE ASSEMBLY INTRODUCTION

We understand building ready-to-assemble furniture can be a challenging experience for some. To help avoid confusion, we have provided some helpful tips that may speed up the process.

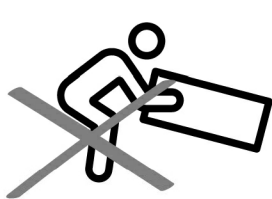

Teamwork

ALWAYS have at least two people to help with transporting and assembling the product to avoid potential injury and/or damage.

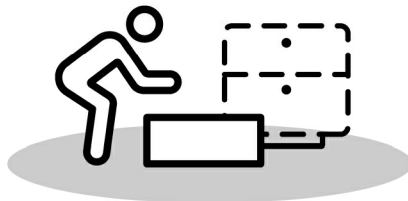
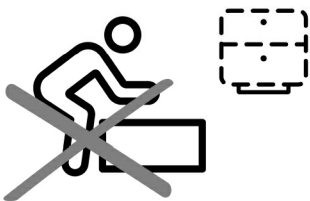

Suitable Location

Assembling near the area of the intended location is highly recommended.



Sufficient Space

Make sure you have enough space to move around during the assembly.

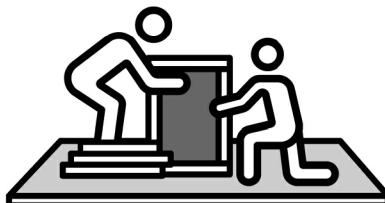

Avoid Scratches

Use cardboard, blankets or a carpeted area while assembling furniture to prevent scratches.

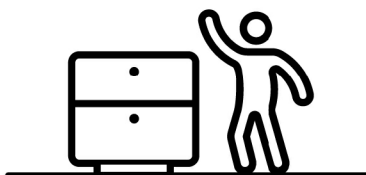
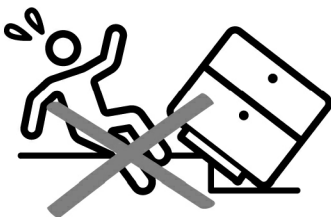

Flat Surface

Make sure the furniture rests on a flat and level surface with each leg evenly touching the floor.

ASSEMBLY AND CARE ADVICE



FAILURE TO FOLLOW THE GUIDELINES BELOW MAY RESULT IN INJURY AND/OR PROPERTY DAMAGE.



Position each part correctly and insert screws or bolts into their respective holes.

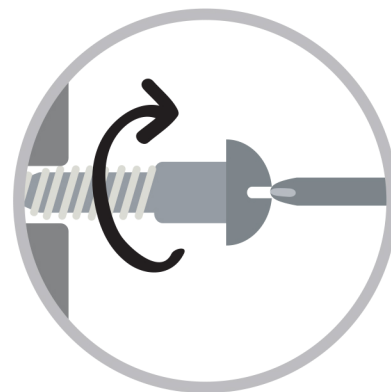

Turn clockwise to tighten and only tighten when step is completed or when instructed to do so.



Use the appropriate hand tools or power tools for assembly. Select steps, such as tightening screws and/or bolts, may require hand tools to avoid causing damage during assembly.



Save the instructions and store any supplied tools for later maintenance.



After two weeks, check and tighten any loose hardware and repeat again every six months thereafter.

IT IS THE USER'S RESPONSIBILITY TO MAINTAIN THE FURNITURE. THE HARDWARE MAY LOOSEN OVER TIME AND MAY CAUSE THE FURNITURE TO BE WOBBLY AND UNABLE TO SUPPORT ITS INTENDED WEIGHT CAPACITY. THIS MAY LEAD TO COLLAPSE AND MAY CAUSE SERIOUS INJURY.

BUFFET



- Please keep instructions for future reference.
- Check the quantity and irregularity of parts and hardware before you start.

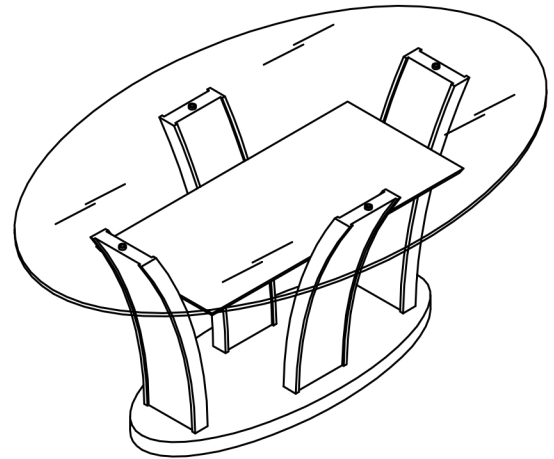

PARTS

#1 4pcs



Leg

#2 1pc

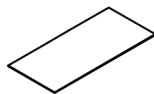

Shelf

#3 1pc

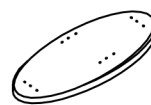

Base

#4 1pc



Glass Top

HARDWARE

#A 8pcs

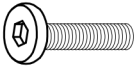

Bolt Ø5/16"X1-3/4"

#B 8pcs



Lock Washer

#C 8pcs



Flat Washer

#D 1pc



Allen Wrench M5

#E 8pcs



Bolt Ø1/4"X1/2"

#F 8pcs



Lock Washer

#G 8pcs



Flat Washer

#H 1pc



Allen Wrench M4

#I 4pcs



L-Bracket

ASSEMBLY INSTRUCTIONS

1

- Part #1 x4pcs
- Part #3 x1pc
- Hardware #A x8pcs
- Hardware #B x8pcs
- Hardware #C x8pcs
- Hardware #E x4pcs
- Hardware #F x4pcs
- Hardware #G x4pcs
- Hardware #I x4pcs

4. Align the top of the legs (#1) to the holes along the top of the base (#3) and insert the prepared bolts. Secure using the Allen wrench (#D).

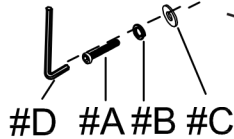

1. Prepare 4 bolt assemblies by first inserting a lock washer (#F) onto the bolt (#E) then a flat washer (#G) onto that same bolt (#E).

2. Align the L-bracket (#I) to the pre-drilled hole along the curved side of the leg (#1) and secure using the Allen wrench (#H).

3. Prepare 8 bolt assemblies by first inserting a lock washer (#B) onto the bolt (#A) then a flat washer (#C) onto that same bolt (#A).

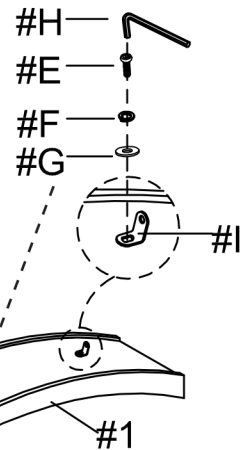

2

- Part #2 x1pc
- Hardware #E x4pcs
- Hardware #F x4pcs
- Hardware #G x4pcs

2. Place the shelf (#2) in between the legs (#1). Align the pre-drilled holes to the L-Brackets (#I). With the help of another person, hold the shelf in place.

3. Insert the bolt assemblies into the L-brackets (#I) to lock with the shelf (#2) and secure using the Allen wrench (#H).

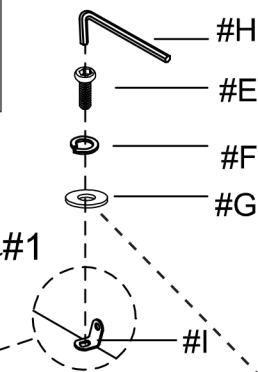
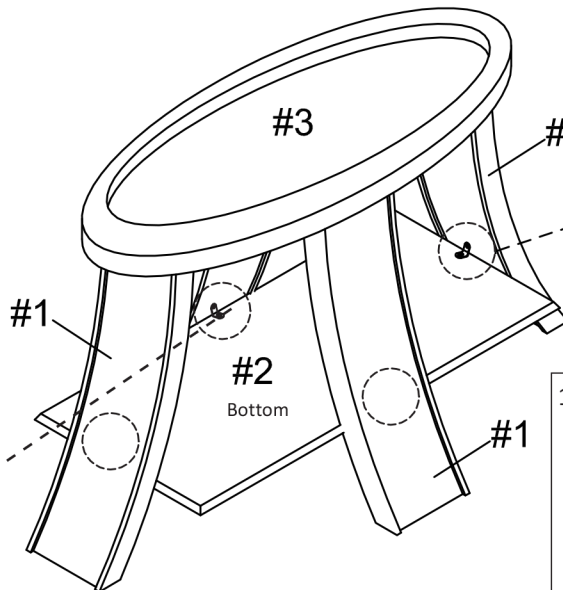

1. Prepare 4 bolt assemblies by first inserting the lock washer (#F) onto the bolt (#E) then a flat washer (#G) onto that same bolt (#E), in that order.

ASSEMBLY INSTRUCTIONS

3

Part #4 x1pc

1. Carefully turn the completed table upright. Make sure the table is rested on a flat surface and does not feel loose or wobbly. If it does, double check that the bolts are secured and properly tightened.

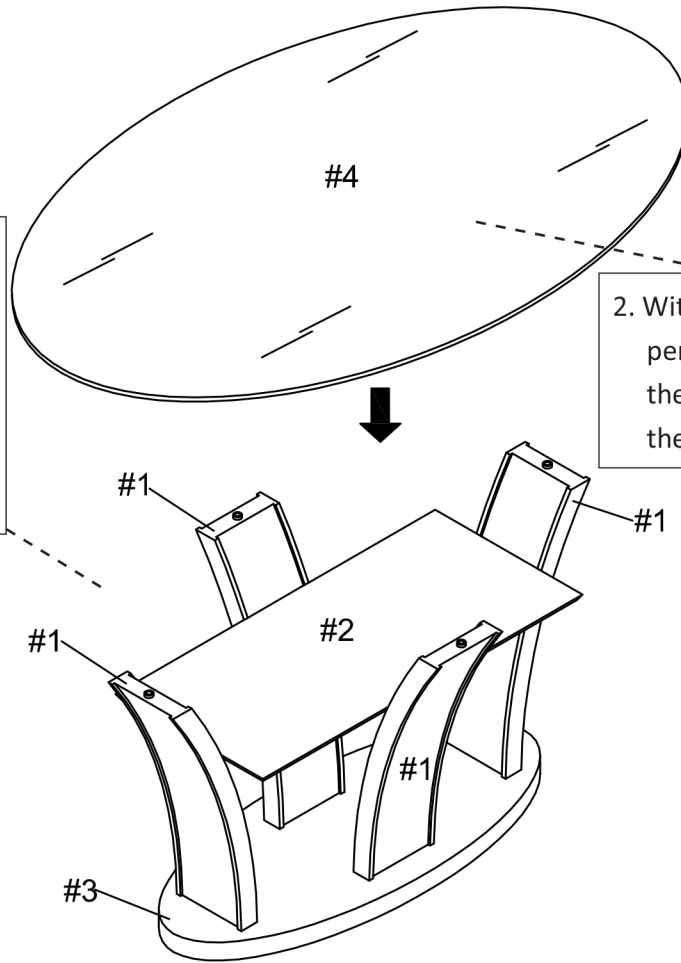

2. With the help of another person, carefully place the glass top (#4) onto the top of the legs (#1).

4

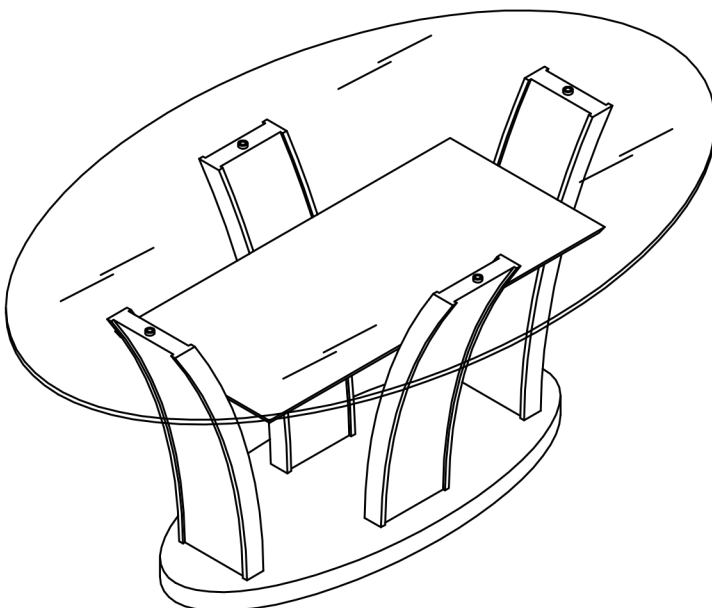

ASSEMBLY COMPLETED



Please ensure the furniture rests on an even and flat surface. If the product wobbles or feels loose, double-check all bolts and/or screws are properly tightened and secured.



Keep this handy!

Please retain this instruction manual and any order-related information for future reference.