

# *ASSEMBLY INSTRUCTIONS*

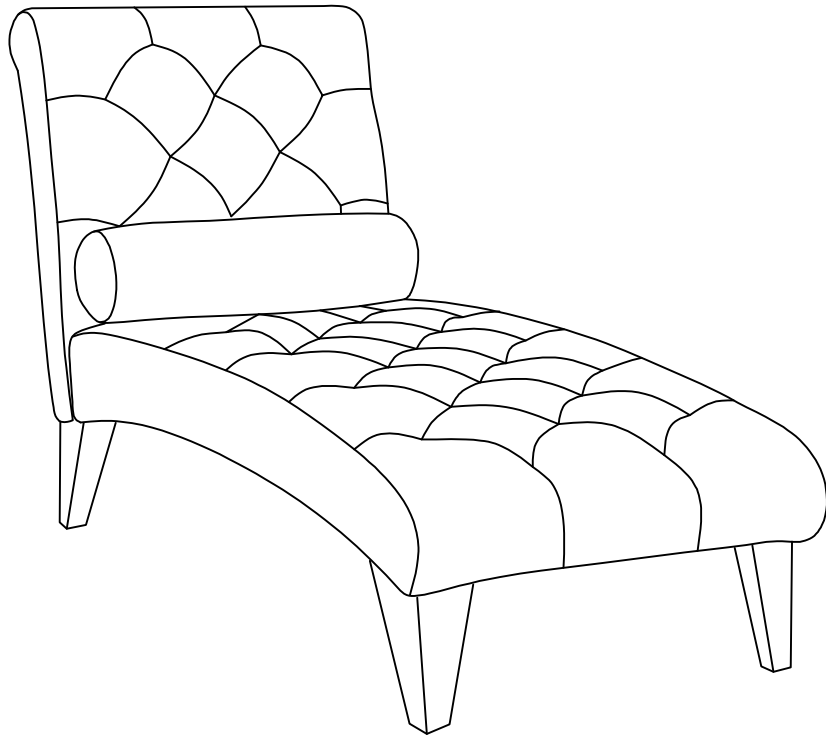

*Fine Furniture for every stage of life*

# ASSEMBLY INSTRUCTIONS

## ASSEMBLY TIPS:

1. Remove hardware from box and sort by size.
2. Please check to see that all hardware and parts are present prior start of assembly.
3. Please follow attached instructions in the same sequence as numbered to assure fast & easy assembly.



### WARNING!



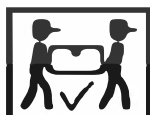

1. Don't attempt to repair or modify parts that are broken or defective. Please contact the store immediately.
2. This product is for home use only and not intended for commercial establishment.





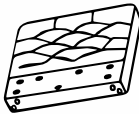
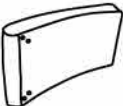





ASSEMBLY TIME

20 MINUTES

## PARTS IDENTIFICATION

A	BACK		1PC
B	COMPLETE SEAT		1PC
C	LEG		2PCS
D	LEG		2PCS
E	PILLOW		1PC

## Z HARDWARE IDENTIFICATION

NO	DESCRIPTION	FIGURE	Q' TY
1	ØALLEN KEY 5/16"		1PC
2	ØALLEN KEY 1/4"		1PC
3	ØBOLT 5/16X3-3/4"		4PCS
4	ØBOLT 5/16X2-1/2"		3PCS
5	ØBOLT 1/4X2-1/2"		8PCS
6	ØLOCK WASHER 5/16"		7PCS
4	ØFLAT WASHER 5/16"		7PCS
5	ØLOCK WASHER 1/4"		8PCS
6	ØFLAT WASHER 1/4"		8PCS

# ASSEMBLY INSTRUCTIONS

## STEP: 1

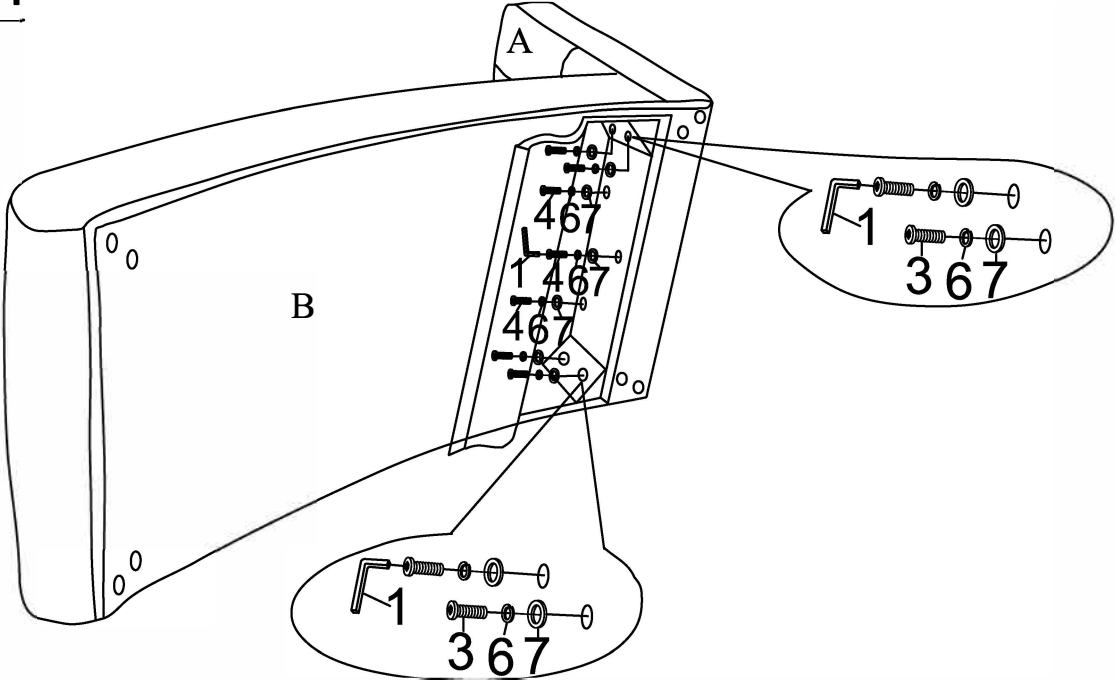

## STEP: 2

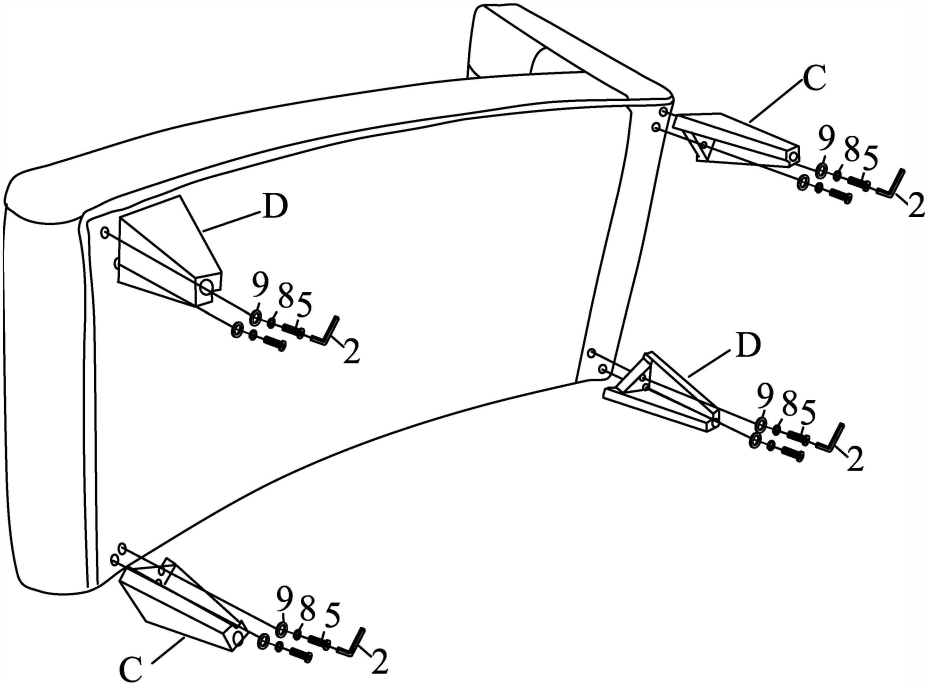

# ASSEMBLY INSTRUCTIONS

