

Read all instructions BEFORE USE of the product.
KEEP INSTRUCTIONS FOR FUTURE USE.

INSTRUCTION

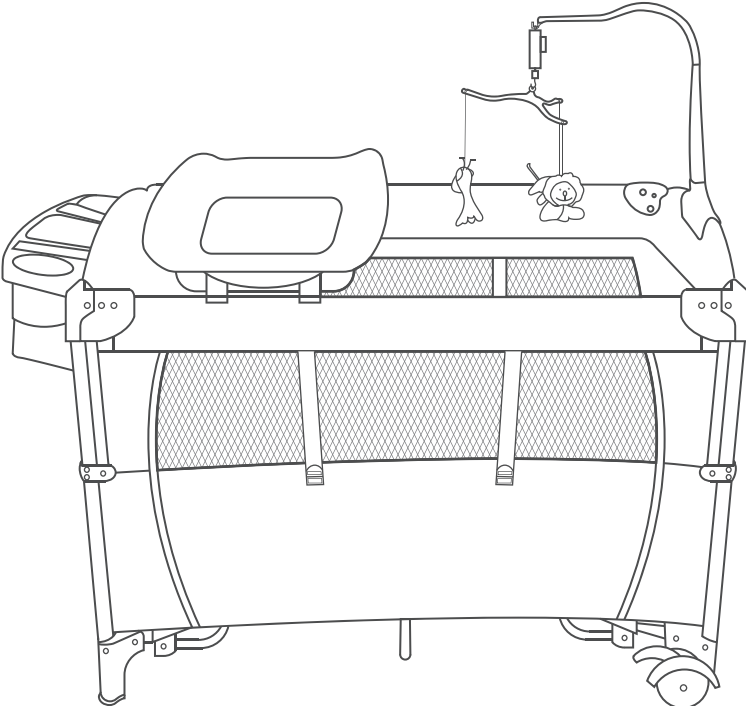

PRODUCT LIST

WHEN OPEN THE PARCEL, PLEASE CHECK IF IT HAS CONTAINED THEM ALL LIKE BELOW:

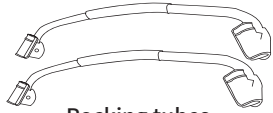

Rocking tubes

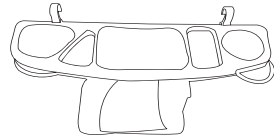

Side storage tray



Mattress

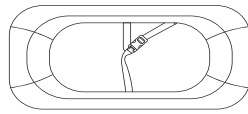

Changing table



Second layer tubes

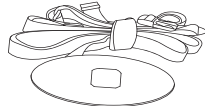

Safety belt

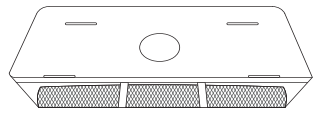

Second layer with zipper

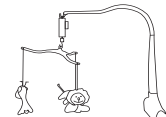

Music & toys rack

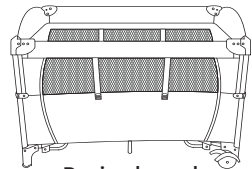

Basic playard

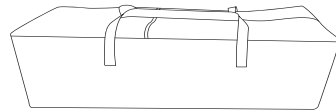

Carry bag

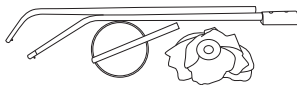

Mosquito net

Accessory	Basic playard	Mattress	Second layer with zipper	Second layer tubes	Safety belt	Carry bag	Side storage tray	Music&toys rack	Mosquito net	Changing table	Rocking tubes
Basic	✓	✓	✓	✓	✓	✓					
Plus	✓	✓	✓	✓	✓	✓	✓	✓	✓		
Deluxe	✓	✓	✓	✓	✓	✓	✓	✓	✓	✓	✓

HOW TO OPEN THE BED

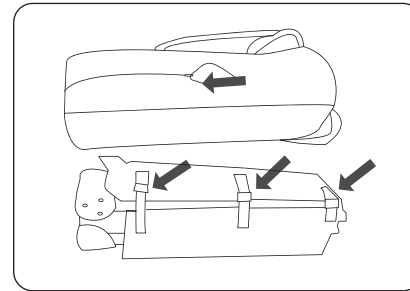

1. Pull up the zipper & take out all from carry bag.

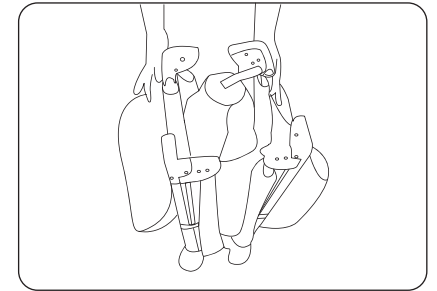

2. Expand 4 feet out.

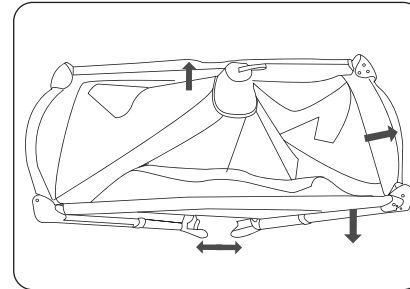

3. Pull up two short sides, and then pull up two long sides.

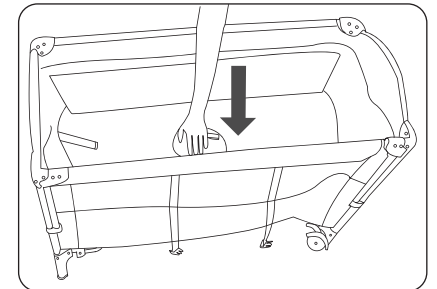

4. Press down from middle places.

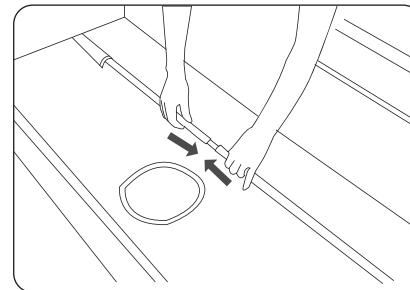

5. Connect 4 tubes.

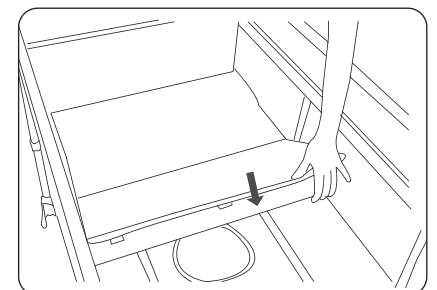

6. Put mattress on second layer.

HOW TO ASSEMBLE CHANGING TABLE

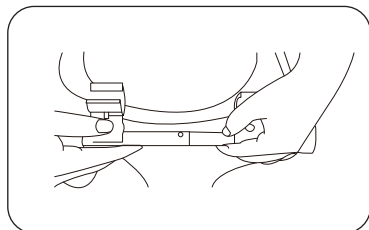
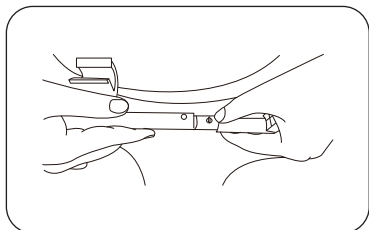

1. Connect two short tubes as shown and repeat step one.

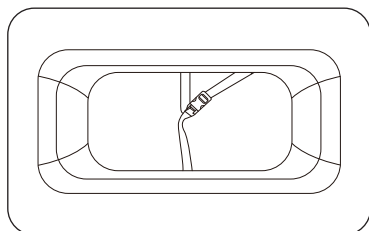
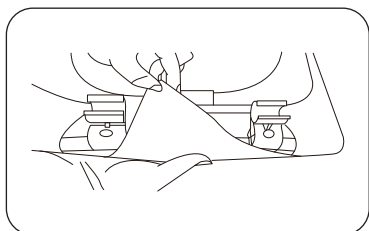

2. Fasten together with velcro straps as shown.

WARNING: DO NOT LEAVE YOUR CHILD UNATTEND IN THE CHANGING TABLE.
NEVER LEAVE CHANGING TABLE IN PLACE WHEN CHILD IN THE BABY PLAYARD.

UPGRADE TO USE AS CO-SLEEPING BED

One side of bed can be lifted up & down to connect with adult bed by 4 different heights.

No.1 height is the height of double layer.
 NO.2 & NO.3 is other two heights as your personal favourite.
 NO.4 is the height of baby bed.

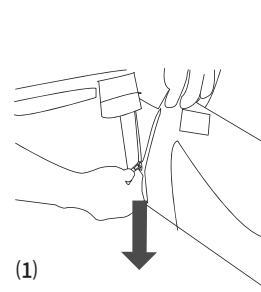
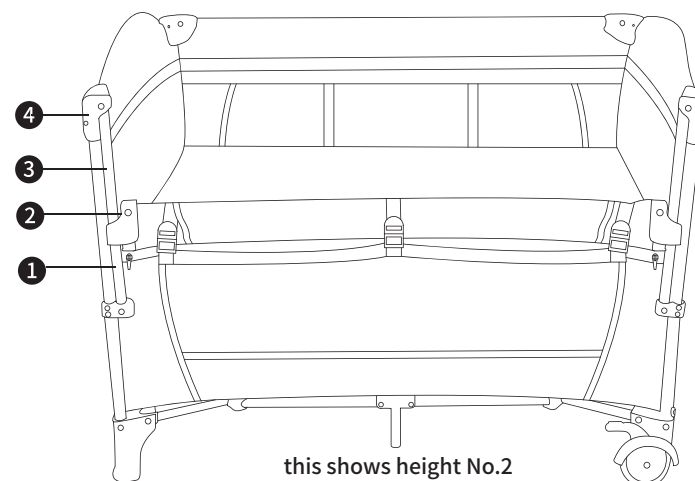

(1)

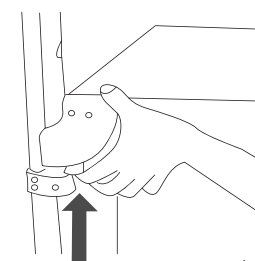

(2)

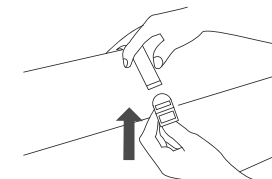

(3)

- (1). pull zipper down to the height of No.1-No.4
- (2). pull up plastic at two sides to the height No.1-No.4
- (3). Roll up fabric & bind it with velcro

SPECIAL NOTICE:

When the folding bed is presented (FIG.11), do not press the bed body hard. Because long side handrail is not pressed completely, you need to fold again to press long side armrest button, until its flank is at right Angle. (FIG.12)

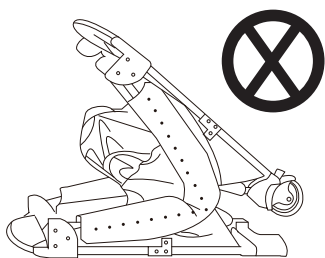

FIG.11

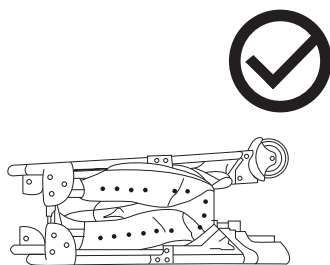
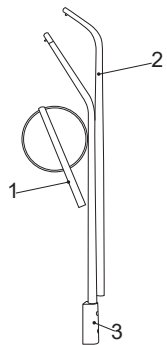

FIG.12

HOW TO ASSEMBLE THE MOSQUITO NET

1. Join the all tubes as the follow step(1-2-3) ,
2. Assemble the mosquito net ,
3. Connect the end of “3” tubes into the baby bed .



Mosquito net tubes

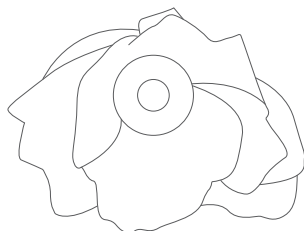

Mosquito net

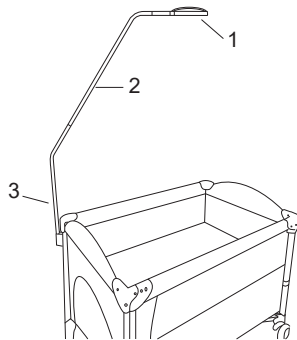

HOW TO ASSEMBLE ROCKING TUBES

Like following pictures&process.Assemble rocking tubes at two bottom short sides;if you want to cancel the rocking tubes,just fold the rocking tubes inside,don't need taking off rocking tubes.

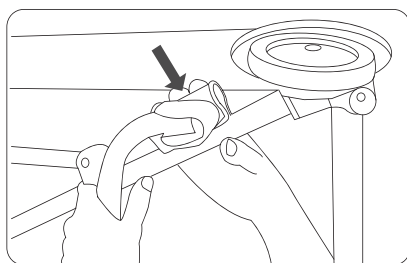
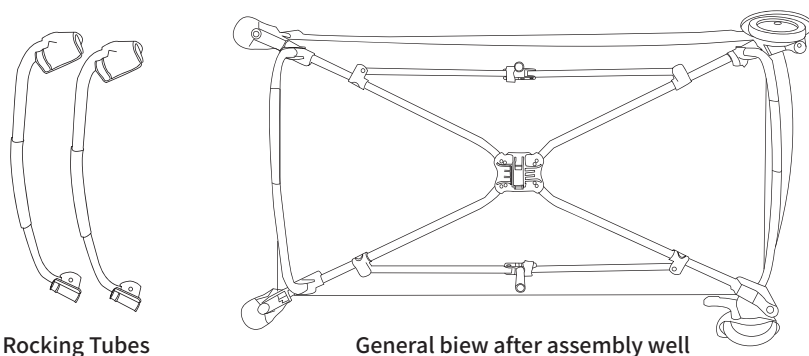

1.find out place at two bottom short side

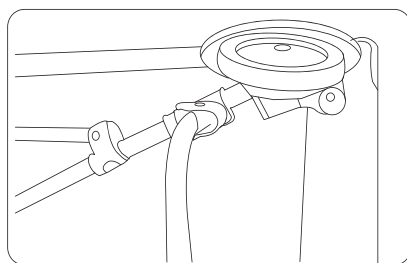

2.press it connecting the bed' s tubes at bottom

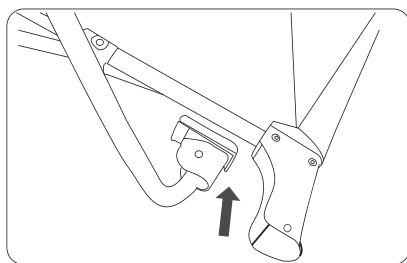

3.Like above picture 1

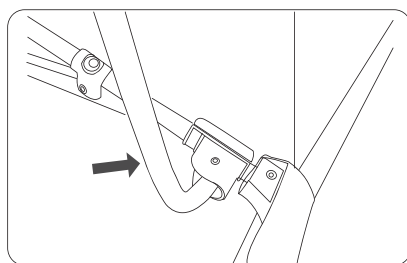

4.Like above picture 2

HOW TO ASSEMBLE MUSIC&TOYS RACK

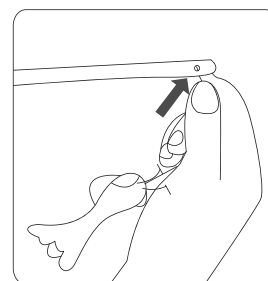
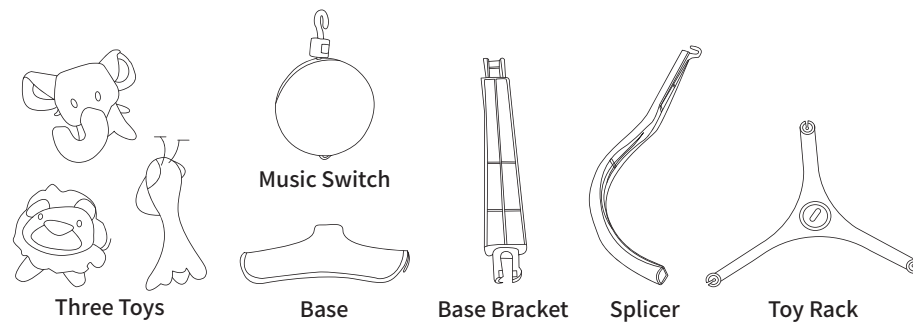

1.put toys on toy rack

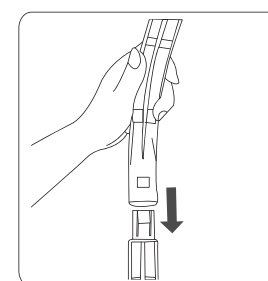

2.Connect two splicers well

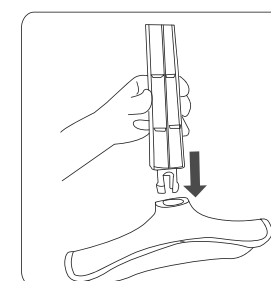

3.Connect base&splicer well

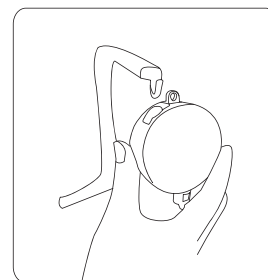

4.put on music switch

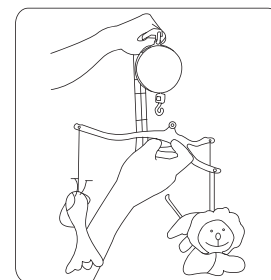

5.put on bracket with toys

Insert the 3toys & toy bars and music box as the shown.

HOW TO CONNECT ADULT BED

To connect the baby bed with adult bed&keep baby from dropping down and harm,we strongly suggest to do like below:

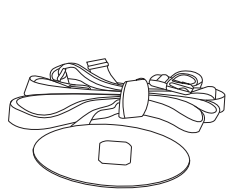
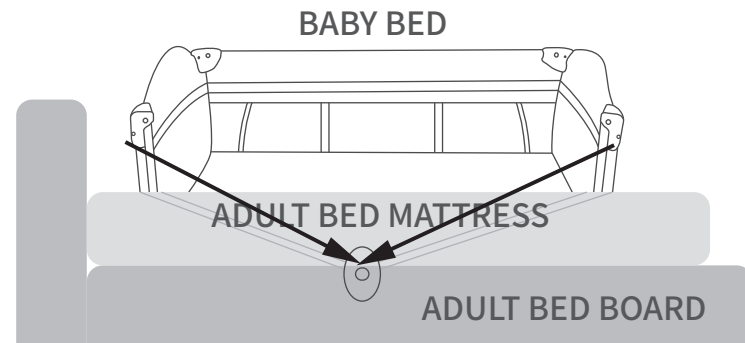

Fixed disk

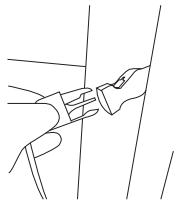

Lock Catch

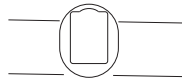

Fixed ribbon

WARNING:

Only when you connect the bay bed with adult bed ,you can drop down the long side top rail .In other cases ,pls DO NO drop down the long side top rail and keep it connect with top corner plastic.

HOW TO FOLD THE BABY BED

- Take off all changing table/music&toys rack/storage rack/ mattress,etc,only leave bed body for folding
- Lift the ring up at the bottom of the bed
- Hold the folding switch in the middle of the handrail, press down & fold two long sides down to shape “V” ; press downw & fold two short sides down to shape “V”
- have all 4 feet together

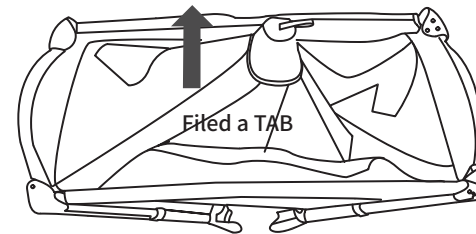

FIG.8

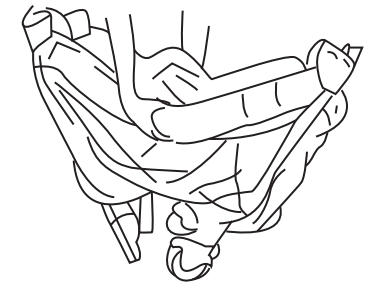

FIG.9

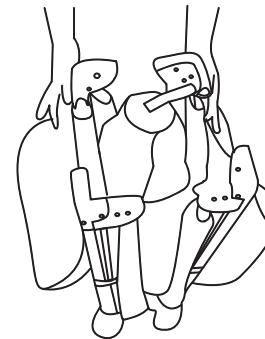

FIG.10

Playard Warnings

⚠️ WARNING: Failure to follow the instructions could result in death or serious injury. Make sure latches are secure. ALWAYS provide the supervision necessary for the continued safety of your child. When used for playing, never leave child. When used for playing, never leave child unattended.

⚠️ WARNING: Failure to follow these warnings and the

instructions could result in serious injury or death.

SUFFOCATION HAZARD

Infants have suffocated

- In gaps between a mattress too small or too thick and product sides.
 - On soft bedding
 - NEVER add a mattress, pillow, comforter, or padding
 - Use ONLY the mattress provided by us
 - The playard mattress/pad is specially designed to prevent suffocation. The playard mattress/pad has a solid base, a certain length and width, and is less than one inch thick in order to meet safety standards . Using a thicker or a different sized mattress/pad may allow a child's head to get between mattress/pad and the side of the playard causing suffocation.
- To reduce the risk of SIDS, pediatricians recommend healthy infants be placed on their back to sleep, unless otherwise advised by your physician.
 - **ALWAYS** place child on back to sleep.
 - **NEVER** use plastic shipping bags or other plastic film as matras covers not sold and intended for that purpose. They can cause suffocation.
 - **NEVER** use a water mattress with this product.

⚠️ WARNING:STRANGULATION HAZARD

⚠️ WARNING: NEVER LEAVE INFANT IN PRODUCT WITH SIDES DOWN. Infant may roll into space between pad and loose mesh side causing suffocation.

- Strings can cause strangulation! **NEVER** place items with a string around a child's neck such as hood strings or pacifier cords. **NEVER** suspend strings over playard or attach strings to toys.
- **NEVER** place the product near a window where cords from blinds or drapes can strangle a child.
- Child can become entrapped and die when improvised netting or covers are placed on top of a playard. Never add such items to confine child in playard.
- **ALWAYS** ensure the full-size bassinet is fully assembled on the playard before using the following accessories: changing table and / or Napper.
- **NEVER** leave child in product with sides lowered. Be sure sides are raised and locked in position whenever child is in product.

⚠️ WARNING: See playard floor and side rails and side rail for warning

- The playard, including side rails, must be fully erected prior to use.
- Make sure latches are secure.
- Discontinue use of the product when child is able to climb out or reaches the height of 35 in. (890 mm), or 30 lbs. (13.60 kg).
- When child is able to pull to standing position, remove bumper pads, large toys and other objects that could serve as steps for climbing out.
- **ALWAYS** ensure that the playard, changing table are safe by checking regularly, before placing the child in it, that every part is properly secured in place.
- **NEVER** leave the Full-size bassinet in place when child is in place playard.
- **NEVER** leave Changing Table in place when child is in the playard
- **NEVER** use this product if there are any loose or missing

fasteners, loose joints, broken parts, or torn mesh/n mesh/fabric. Check before assembly and periodically during use. Contact us

- **NEVER** substitute parts
- This product is not intended for commercial use.

Bassinet Warnings

 **WARNING:** Failure to follow these warnings and the instructions could result in serious injury or death.

SUFFOCATION HAZARD

Babies have suffocated

- In gaps between a wrong size mattress, or extra padding and product sides.
- On pillows, comforters and extra padding
- Use only mattress provided by manufacturer .
- NEVER add soft padding and padding.
- Always place baby on back to sleep to reduce the risk of SIDS and suffocation.
- If a suffocation with the pad, use only the one provided by the product manufacturer or one specifically designed to fit the dimension of the product mattress.

FALL HAZARD - To help prevent falls

- Do not use this product when the infant begins to push up on hands and knees or has reached , the height of 25in.(635mm), weight of 15lbs.(6.8kg) or 3months old, whichever comes first
- Strings can cause strangulation! Do not place items with a string around a child's neck, such as hood strings or pacifier cords. Do not suspend strings over a product or attach strings to toys.
- Do not use if any part of the full-size bassinet is broken, torn, or missing.
- To reduce the risk of SIDS, pediatricians recommend healthy infants be placed on their backs to sleep, unless otherwise advised by your physician.

FALL HAZARD - Always check that the bassinet is securely locked on the base/stand by pulling upwards on the bassinet bed.

- Do not place any cord, strap or similar item in or near this accessory that could become wrapped around a child's neck.

- **NEVER** leave bassinet in place when child is in the Playard. Only one child can use the Playard/Nursery Center at any time.

- **NEVER** leave Changing Table in place when child is in the playard.

- **NEVER** place a child under the bassinet.

- The bassinet must be fully assembled and installed before using.

- The playard, including side rails, must be fully erected prior to use. Make sure each latch is secure.

- **ALWAYS** provide the supervision necessary for the continued safety of your child.

- **NEVER** leave children unattended.

- **ALWAYS** provide the supervision necessary for the continued safety of your child. **NEVER** leave children unattended.

- Child can become entrapped and die when improvised netting or covers are placed on top of a playard. Never add such items to confine child in playard.

 **WARNING:** Failure to follow the instructions could result in serious injury or death.

SUFFOCATION HAZARD

Infants have suffocated

- In gaps between extra padding and sides of the bassinet/cradle, and
 - On soft bedding
- Use only the pad provided by manufacturer. **NEVER** add a pillow, comforter, or another mattress for padding. To reduce the risk of SIDS, pediatricians recommend healthy infants be placed on their back to sleep, unless otherwise advised by your physician.

Changing Table WARNING

WARNING-FALL HAZARD: Children

have suffered serious injuries after falling from changing tables. Falls can happen quickly

- **STAY** in arm's reach of your child
- **ALWAYS** secure this product to the support frame by (manufacturer's instructions for securing the changing unit/pad). See instructions.

SUFFOCATION HAZARD: Babies have suffocated:

while sleeping on changing tables. Changing tables are not designed for safe sleep.

- **NEVER** allow baby to sleep on changing table.
- **NEVER** leave the changing table in place when the child is in the bassinet or the playard. Always remove the changing table while not in use. To prevent your child from falls and other injuries, always use the safety belt when children are on the changing table.
- Discontinue use of the changing table when child begins to push up on hands and knees or has reached the height of 22 in. (558.8 mm), weight of 15 lbs. (6.80 kgs) or 3 months old, whichever comes first.
- Do not use changing table if it is damaged or broken.
- **ALWAYS** use the restraint system. Adjust belt as needed to get a snug fit.

Toys WARNING

ACCESSORIES

Warnings for Toy Accessories including Toy bar/Mobile Canopy with toys

 **WARNING:** Discontinue use the play yard when child is able to climb out or reaches the height of 35- in. (890- mm or 89- cm). Toy bar is a possible entanglement injury. Keep out of baby's reach. Remove toy bar from play yard when baby begins push up on hands and knees. From birth to 5 months

WARNING:

- Possible entanglement injury.
- Keep out of baby's reach.
- Remove Toy bar/Mobile/Canopy with toys when baby begins to push up on hands and knees. Recommended use from birth to 5 months.
- Toys are not intended to be mouthed by the baby and should be positioned clearly out of reach of the baby's face and mouth.
- **ALWAYS** attach all provided fasteners (strings, straps, clamps, etc.) tightly to playard according to these instructions. Check frequently.
- Do not add additional strings or straps to attach to any other crib or playpen.
- The Toy bar/Mobile/Canopy with toys is intended for visual stimulation and not to be grasped by the child.

