

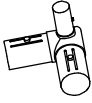

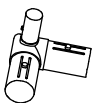



# SOCCER GOAL

## SIZE : 3650\*1820\*1200mm

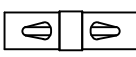
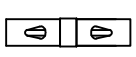
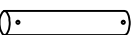
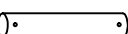
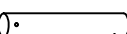
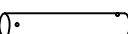
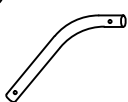
### PART LIST

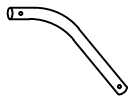
(A)  2PCS	(B)  2PCS	(C)  2PCS	(D)  6PCS	(E)  4PCS	(1)  6PCS
JOINT	JOINT	JOINT	JOINT	JOINT	ø68x1140
(2)  2PCS	(3)  2PCS	(4)  2PCS	(5)  1PC	(6)  1PC	(7)  1PC
ø68x815	ø68x815	ø68x1050	ø40x700	ø40x700	ø40x700
(8)  1PC	(9)  2PCS	(10)  24PCS	(11)  6PCS	(12)  1PC	
ø40x700	ø40x640	PUSH MOUNT TIE	EARTH NAIL	NET	

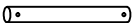
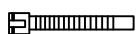
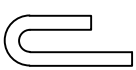
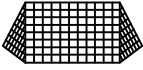
Remark: The soccer goal is suitable for children 6+years old.

Warning: Soccer goal must be assembled and used under the guardianship of adults.

### ASSEMBLY

#### A

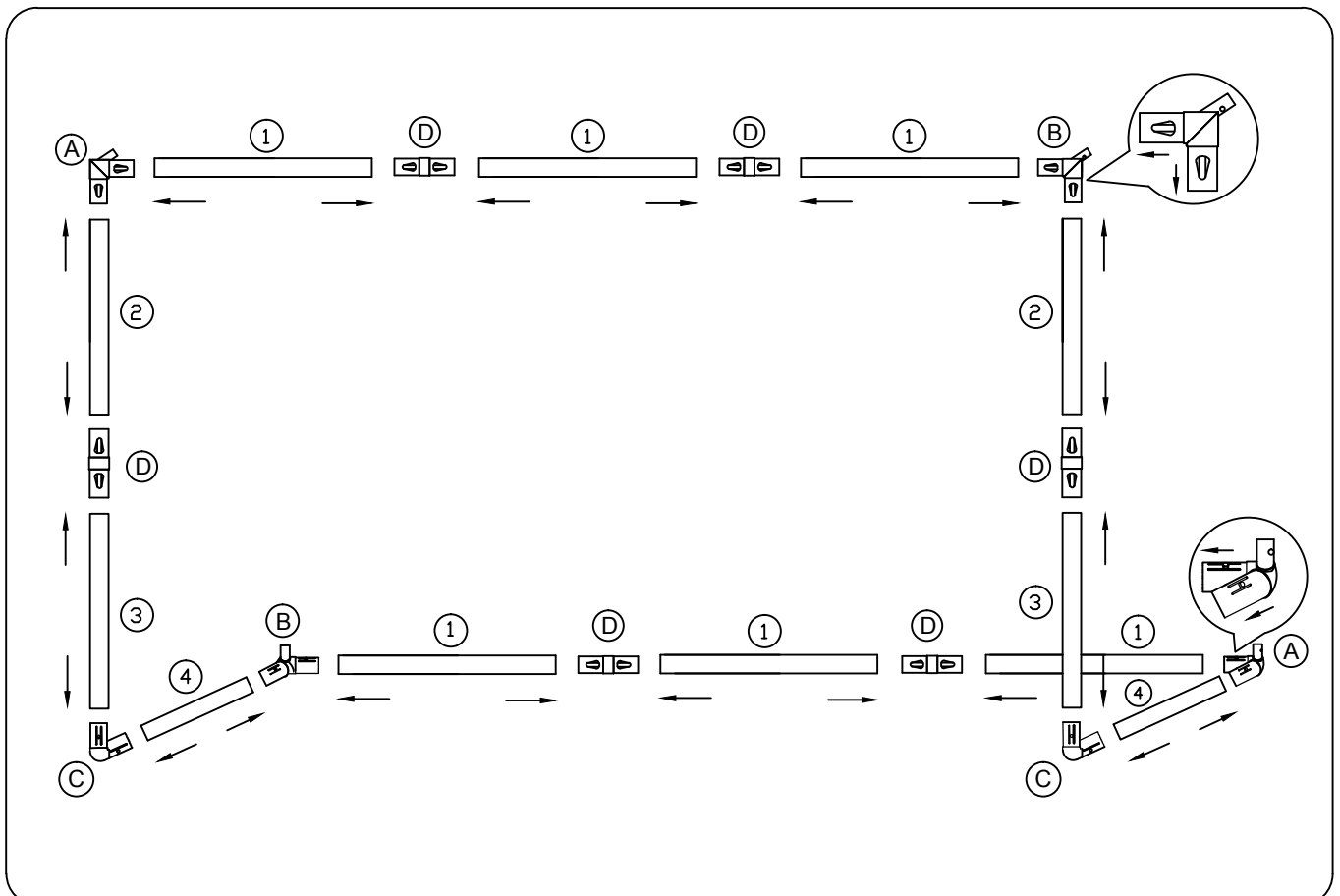

A. Assemble the frame according to the serial number marked.

B

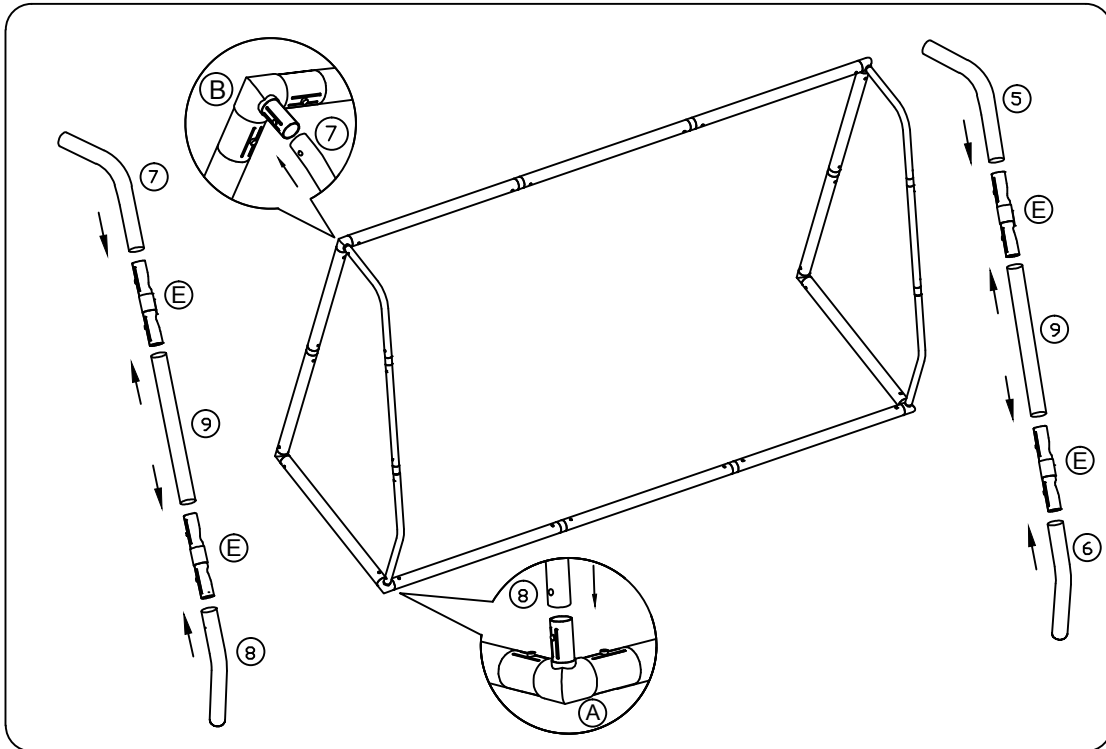

B. Assemble the rear support frame.

C

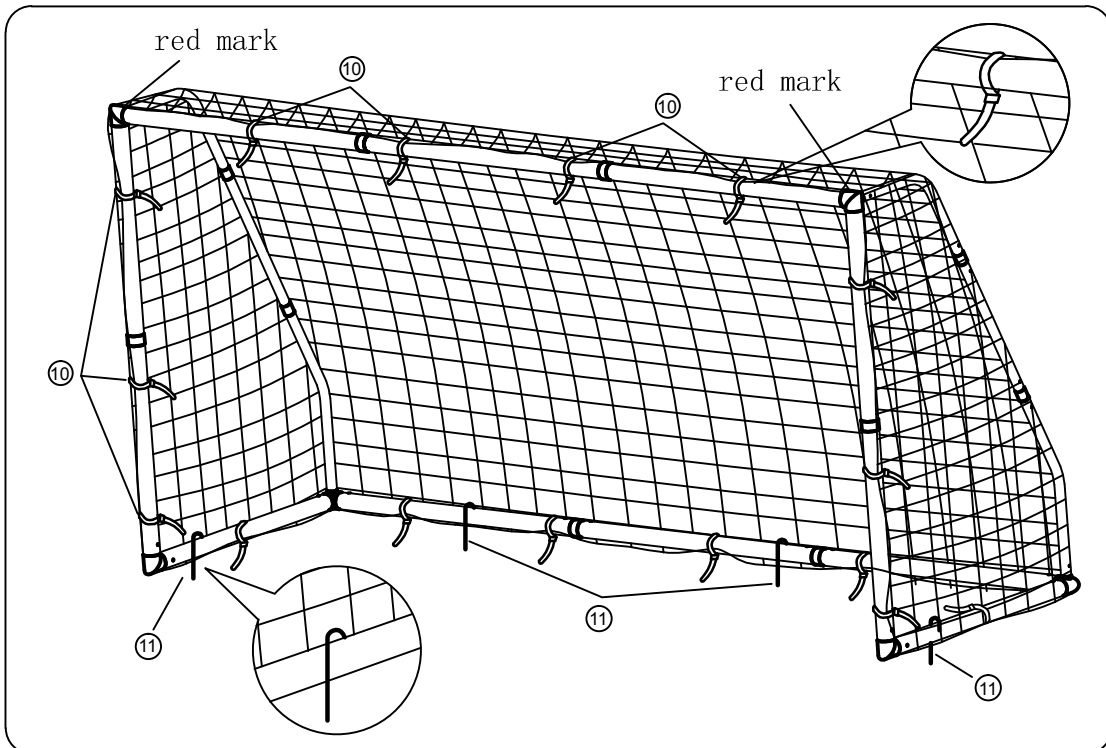

C. To attach net to goal, first please find two red marks on the top of the goal net, in this direction, attach it on the top goal post, then tie the rope and the post with push mount tie#10 and fasten it.

Please fixed the goal with the earth nail#11.

The long side of the ground nail face down, then insert the underground.

