

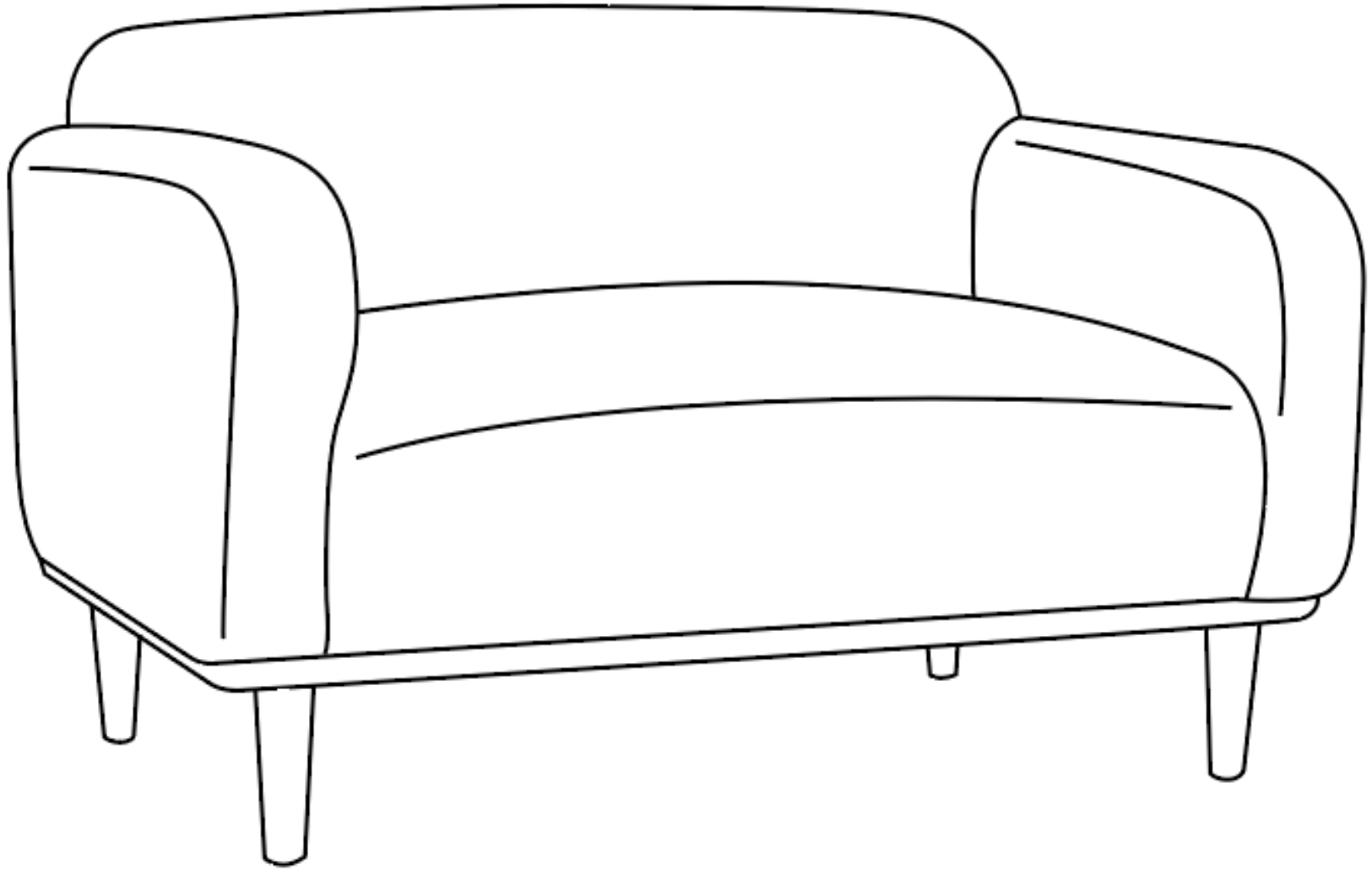

Assembly Instructions

Caution: You must read this before you proceed

Loveseat

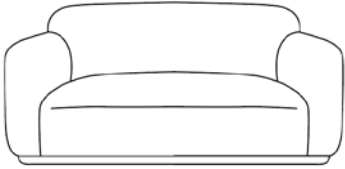

Part List

Label	Picture	Description	QTY
A		Sofa	1
B		Sofa Leg	4

Hardware

Label	Picture	Description	QTY
1		Gasket	7

Assembly Preparation

Before Beginning Assembly:

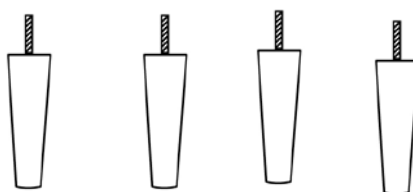
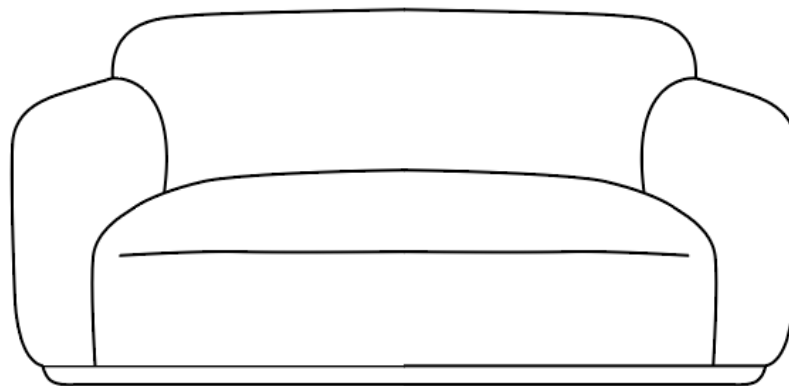

- Read instructions, cover to cover-

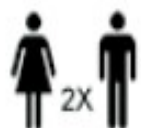

- Have 2 adults on hand for assembly-



- Do not assemble on flooring or carpet-



- Assemble on a clean non-marring surface (packing foam)-



- Save all packaging until finished-

Assembly Steps

Overview

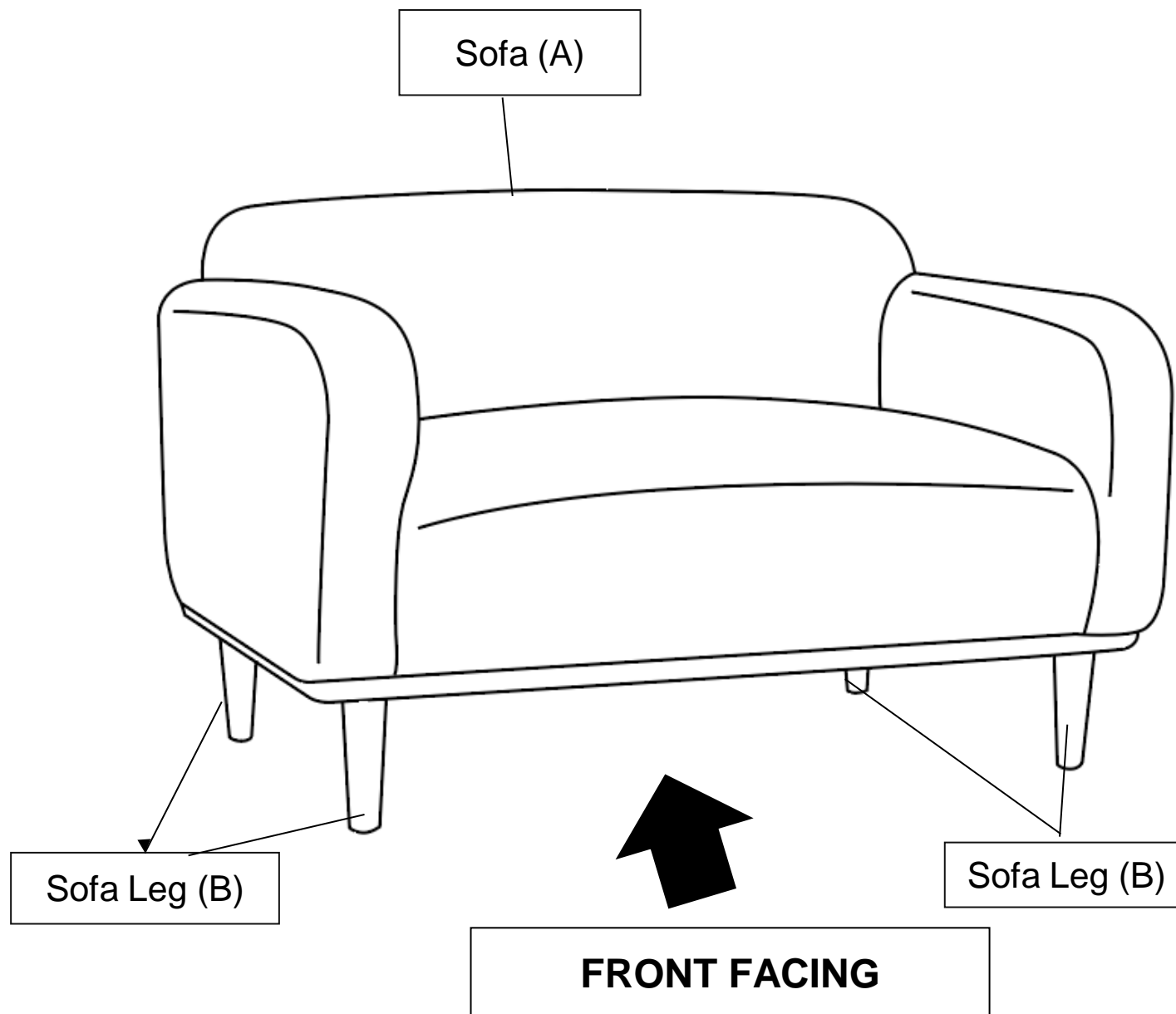

This Loveseat has multiple parts and may require up to 30 minutes to assemble. To give you an overview of the Loveseat parts, the above picture is to help you put the various parts into perspective. Please read through the instructions below to familiarise yourself with the parts and steps before assembly.

Note: It is recommended that you have an adult partner to assist during the entire assembly process.

Step 1

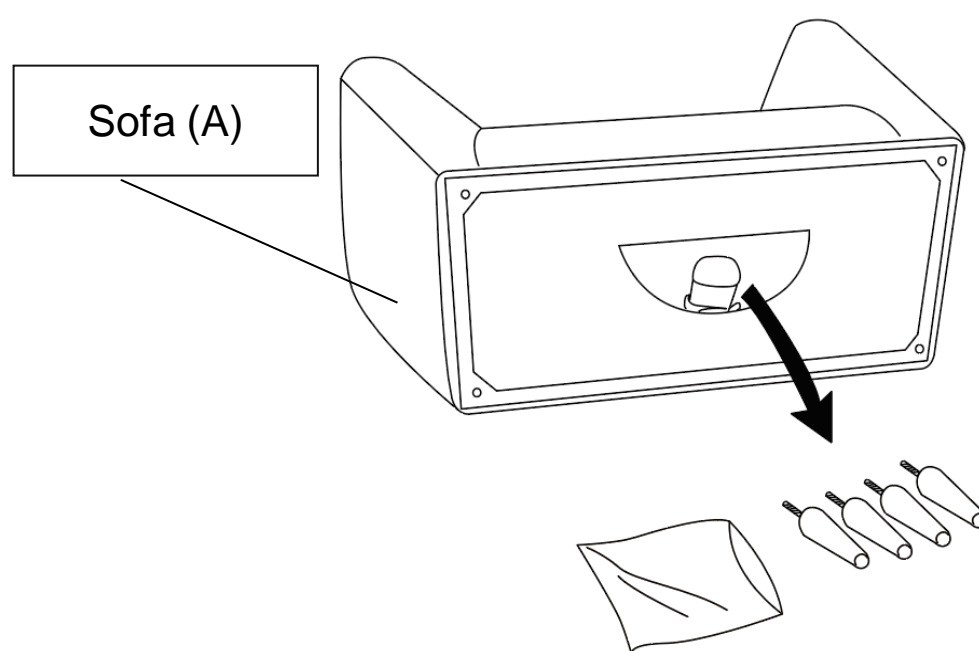

With assistance from your adult partners, position the Sofa(A) on it's back on a clean,non-marring surface, as shown.

Unzip the pouch and remove the four Legs and Hardware.

Close the pouch before assembling.

Step 2

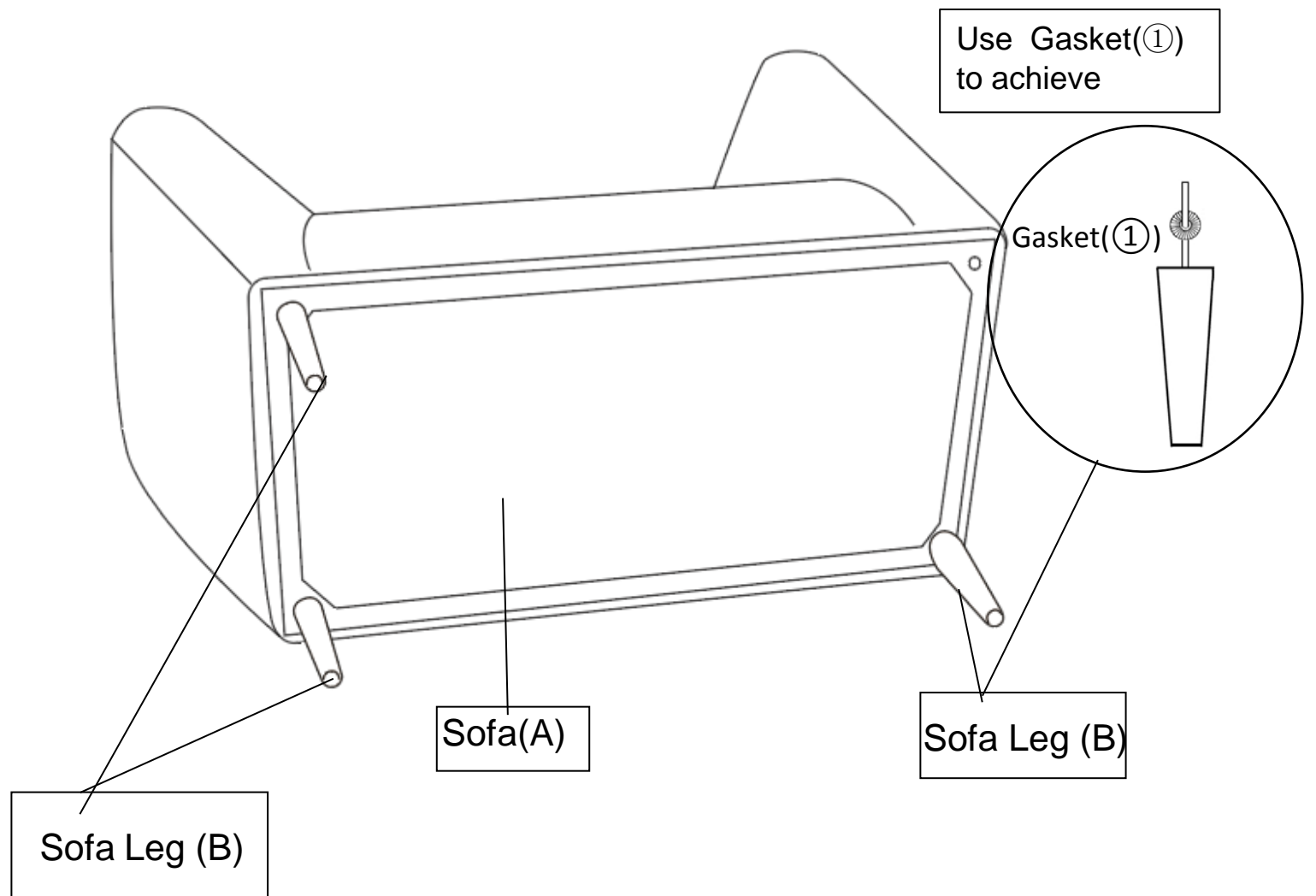

Install the Sofa Legs(B) into the bottom of the Sofa(A) by placing one Gasket(1) onto the threaded stem. Insert the threaded stem of the Leg(B) into the front mounting positions of the Sofa(A) then tighten by turning the leg clockwise until the leg is completely secure.

Repeat this process with the remaining three legs.

Note: The use of the Washer Rings is OPTIONAL and are especially useful to help alleviate slight wobbleness. Some legs may need more than one whilst some legs may not need any.

Step 3

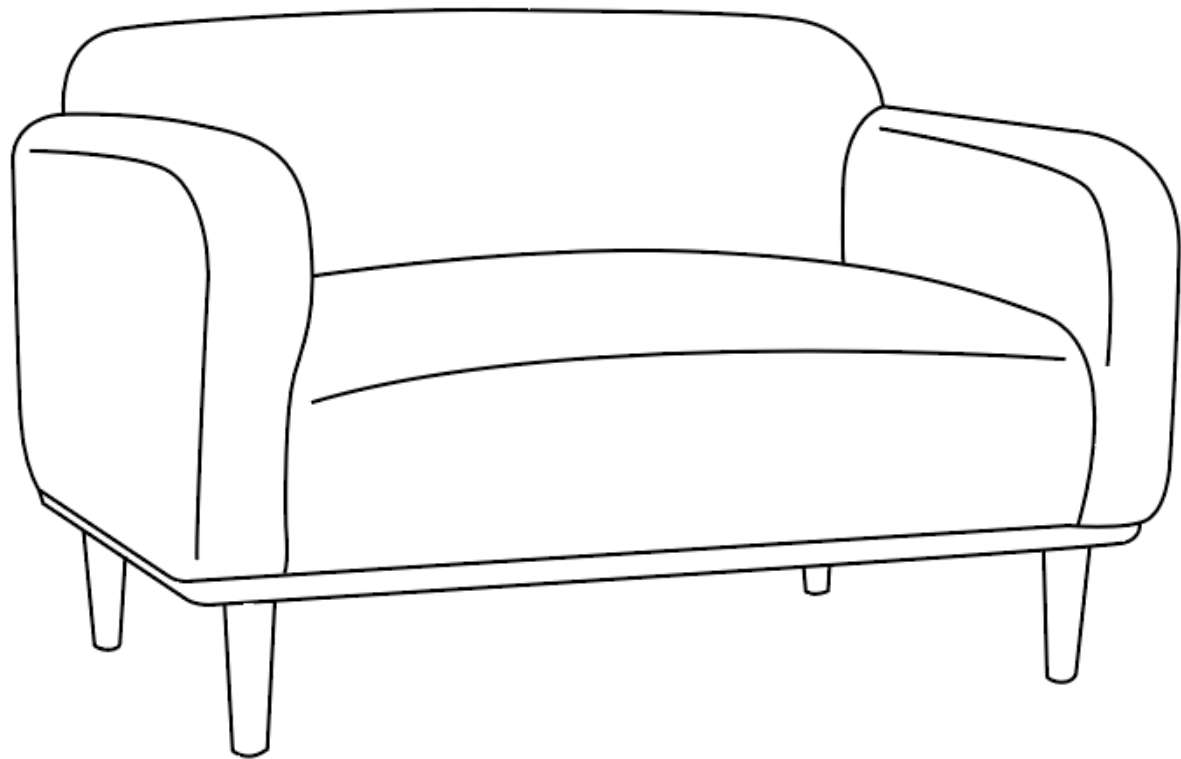

Make sure all parts are connected and locked into position.

Your Loveseat is ready for use.

This Loveseat can only be used on a flat, level surface.

Care & Maintenance



- Furniture may scratch floors. We recommend using furniture pads to protect your floors.



- Do not put hot items directly on furniture surface.



- Do not clean furniture with harsh cleansers or polish.



- Do not place furniture under direct sunlight.



- Do not place furniture near heating or cooling vents.



- Do not write on furniture without a padded barrier to protect the surface.



- Do not place furniture outside . For indoor use only.



- Not for commercial use. For residential use only.



- Stains may be removed with mild soap solution and damp cloth.



- Children should not climb or jump on the furniture.



- Dust and pick-up spills using a clean, non-colored, lint-free cloth.