

# WALL MOUNT

## Assembly Instructions

MODEL#: 8098WL-03BK-US 8098WL-03GD-US 8098WL-03SN-US



### CAUTION

• Inspect the wire insulation for any cuts, abrasions, or exposed copper that may have resulted during shipping. If there is a defect in the wire, do not attempt installation.

• Before starting installation of this fixture or removal of a previous fixture, disconnect the power by turning off the circuit breaker or by removing the fuse at the fuse box.

### TOOLS REQUIRED



Ladder



Safety glasses



Electrical tape



Phillips screwdriver

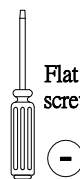

Flat blade screwdriver



Pliers

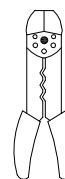

Wire strippers

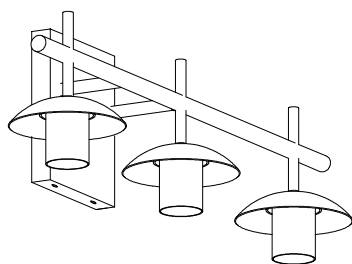

Lamp body

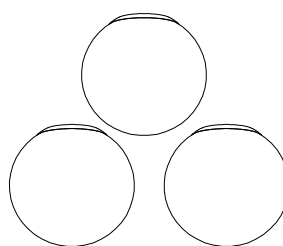

lamp shade



Mounting Unit



Wire Nuts

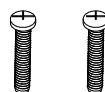

Mounting Screws

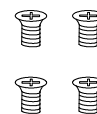

Mounting Screws



\*PARTS SHOWN MAY DIFFER SLIGHTLY PER LIGHT FIXTURE

# WALL MOUNT

## Assembly Instructions

MODEL#: 8098WL-03BK-US 8098WL-03GD-US 8098WL-03SN-US

### STEP 1

Fix the mounting plate on the junction box with screws.

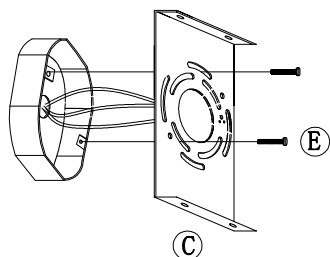

### STEP 2

Make the electrical connection from the junction box to the fixture. Connect the ground wire to the mounting unit using the preinstalled green ground screw. Then, connect the positive, negative and ground wires with the supplied wire nuts (F). Secure with electrical tape

Connect Clear, Brown, Gold or Black Parallel Wire without tracer (round & smooth) or Black Fixture Wire to:

Black or Red Supply Wire or Insulated Wire (other than green) with copper conductor.

Connect Clear, Brown, Gold or Black \*Parallel Wire with tracer (square & ridged) or White Fixture Wire to:

White Supply Wire or Insulated Wire (other than green) with silver conductor

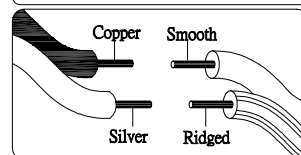
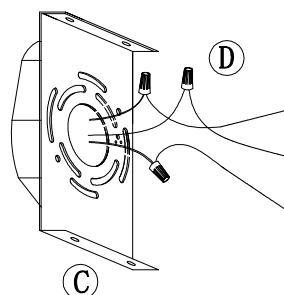

### STEP 3

Fix the canopy on the mounting box with screws.

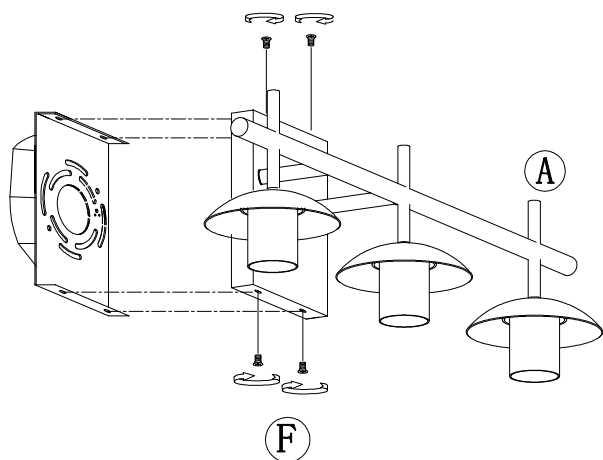

### STEP 4

Install the bulb (Bulbs NOT Included), E 26 TYPE T 6\*40W

Install the lampshade onto the lamp body

