







## ASSEMBLY INSTRUCTIONS

NO	Parts list	QTY
1	table top	1pcs
2	Connection board	1pcs
3	foot box	1pcs
4	foot box	1pcs

NO	Hardware	QTY
A	 Ø 1/4" * 1-1/8" Bolt	14pcs
B	 Ø 1/4" * 2-1/8" Bolt	2pcs
C	 Ø 1/4" * 19mm Flat washer	16pcs
D	 Ø 1/4" Spring washer	16pcs
E	 Ø 1/4" All-Wrench	1pcs
F		1pcs
G	 8#X3/4" Screw	4pcs

step 1

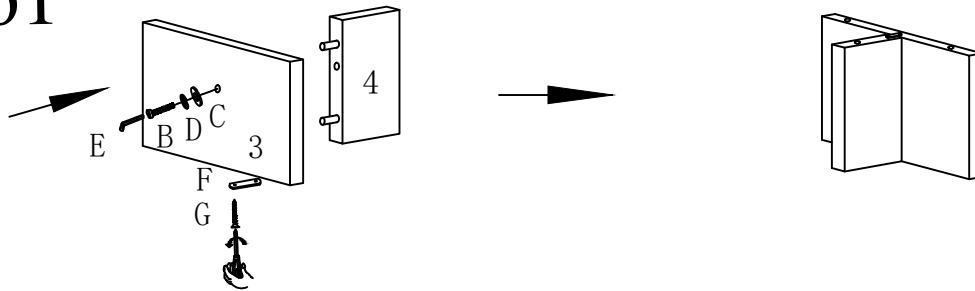

step 2

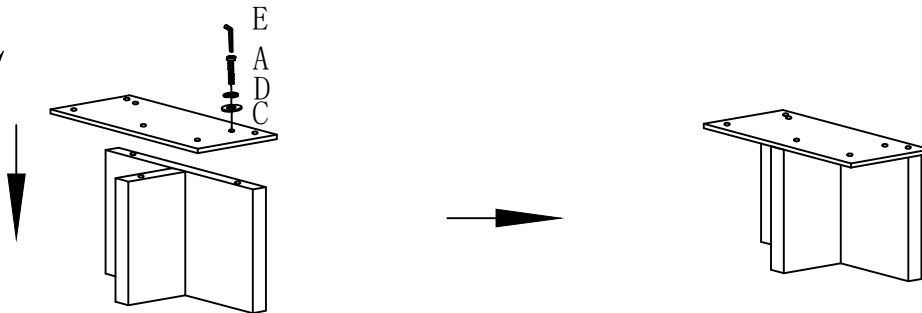

step 3

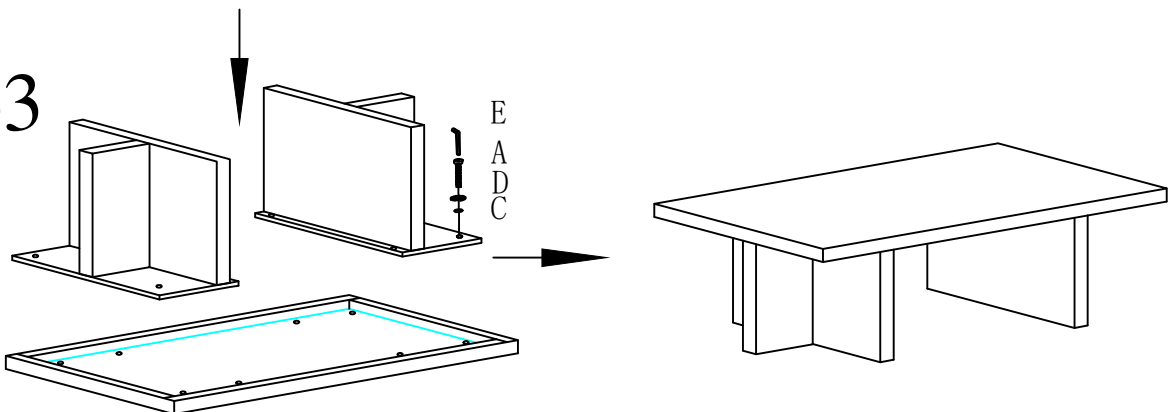

Do not tighten screws until completely assembled