

36" SINGLE VANITY

Assembly Instructions

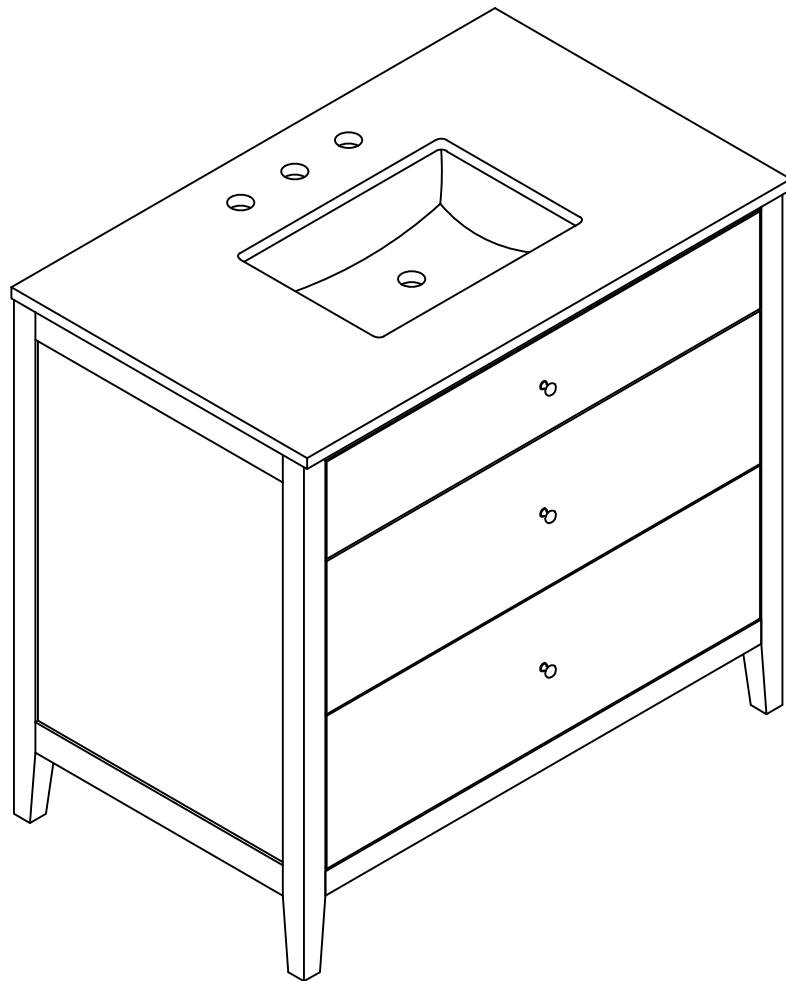

Every thing we make is incredibly simple to set up, including your new vanity. You won't need any additional tools.

Parts List

A x 1
MAIN BODY

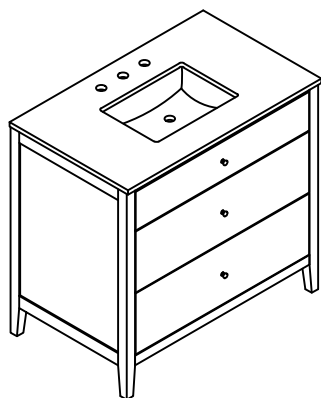

1

Adjust the levelers on the bottom of the feet as needed to make the Vanity Body (A) level.

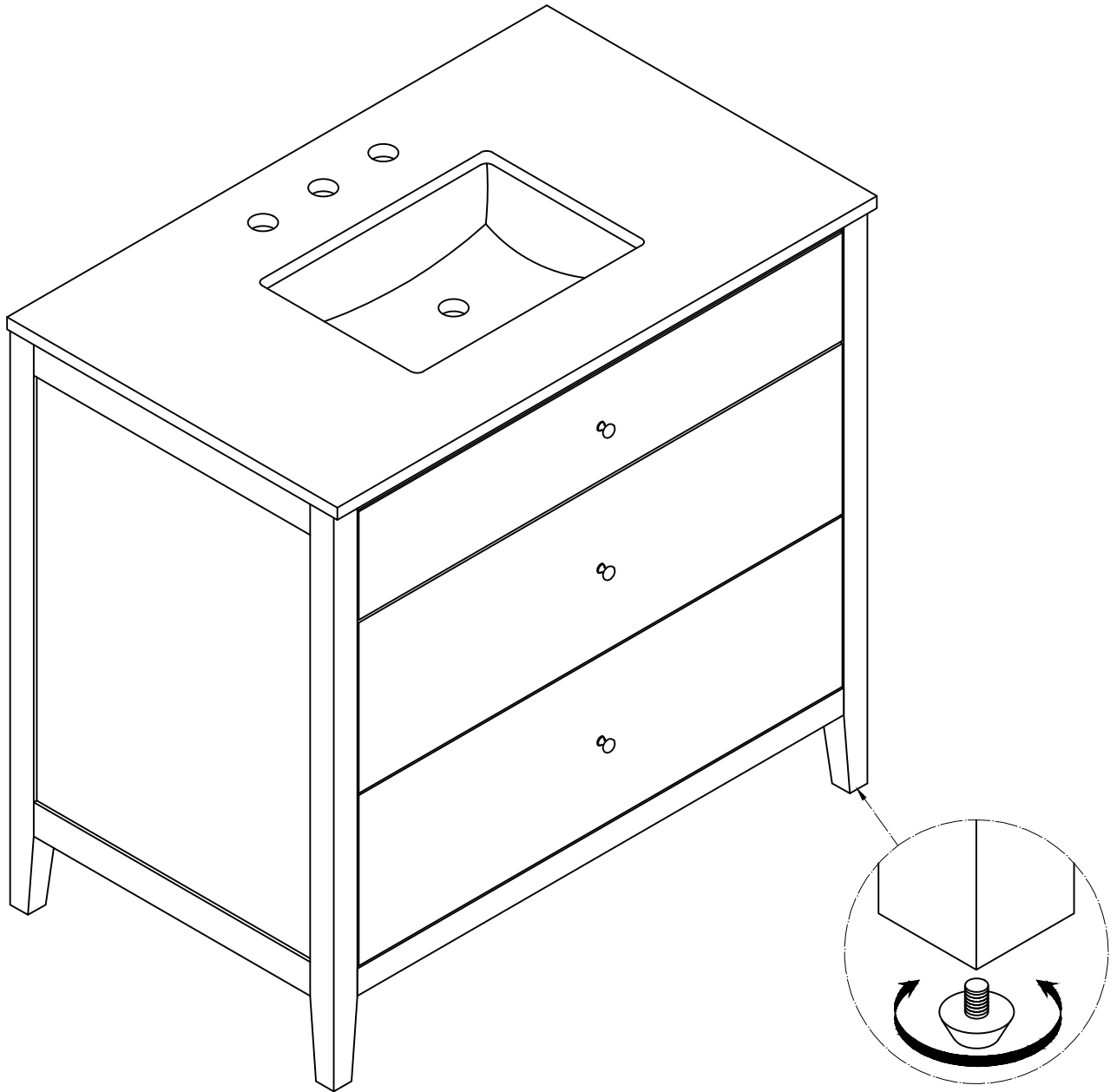

To remove the drawers, detach the male slide from the female slide by pressing up on the tabs and pulling the drawers forward. To reattach the drawers, align the male slides with the female slides and push the drawers in gently.

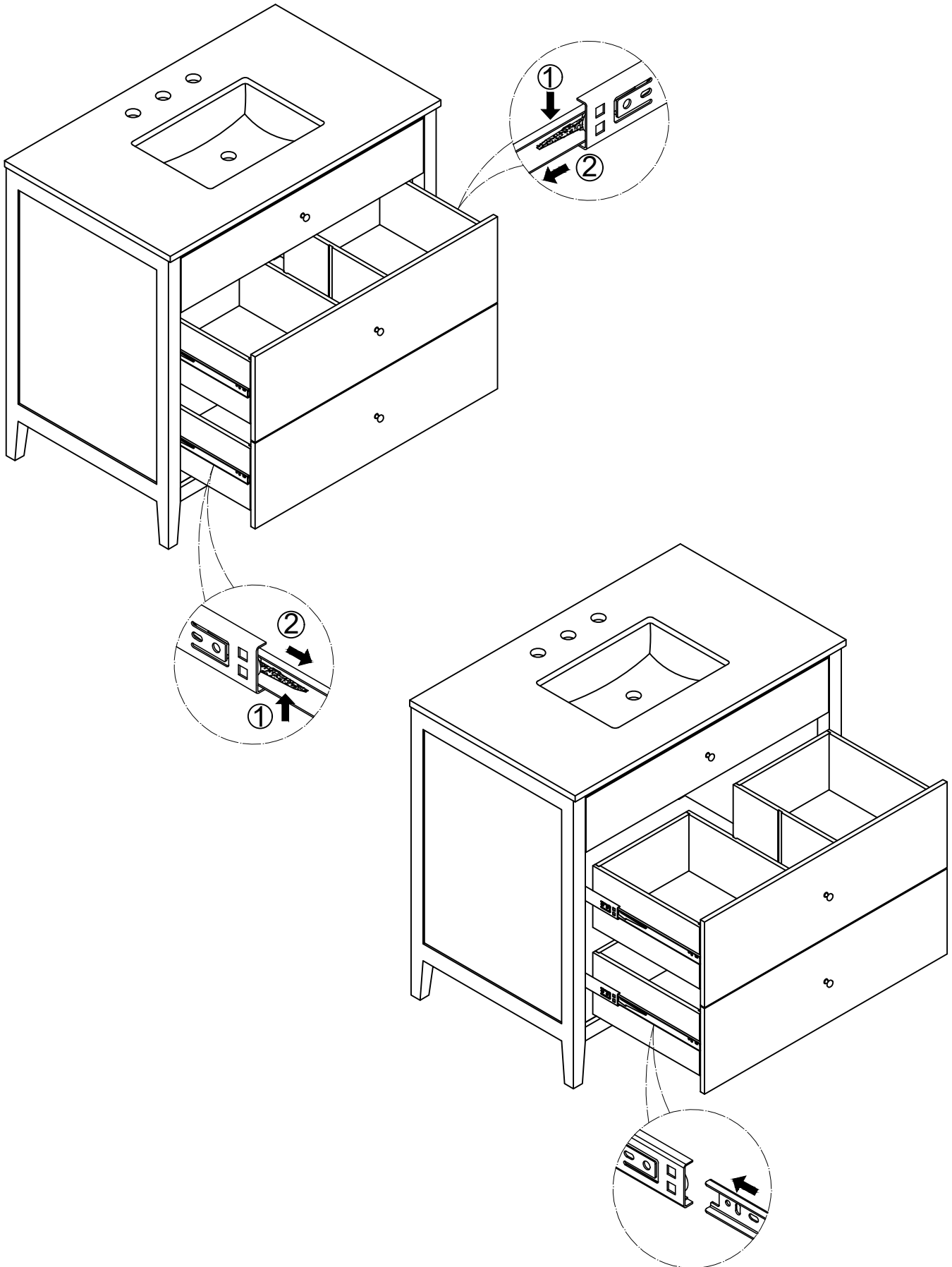

Place the Vanity in the place where you will use it. We'd love to see it – just tag us and use on Instagram!

