

ASSEMBLY INSTRUCTION

6/6 PANEL HB/FB

6/6 PANEL RAILS

BEFORE YOU START ASSEMBLING,
PLEASE MAKE SURE ALL PARTS & HARDWARE ARE INCLUDE IN BOX :

NO	PARTS	QTY
1	HEADBOARD	1 PC
2	FOOTBOARD	1 PC
3	BED RAILS	2 PCS
4	SLATS	4 PCS
5	SUPPORT SLATS	8 PCS

NO	HARDWARE	QTY
A	STUD BOLT	8 PCS
B	SQUARE WASHER	8 PCS
C	HEX NUT	8 PCS
D	SCREW	8 PCS
E	WRENCH	1 PC

STEP-1

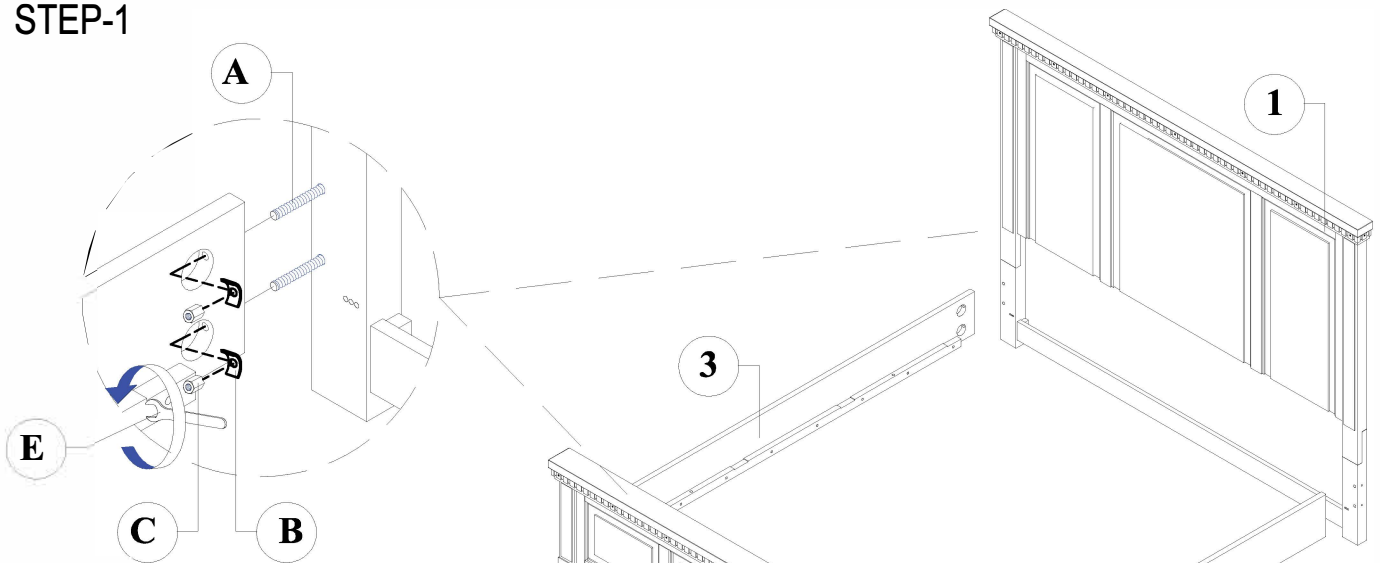

STEP-2

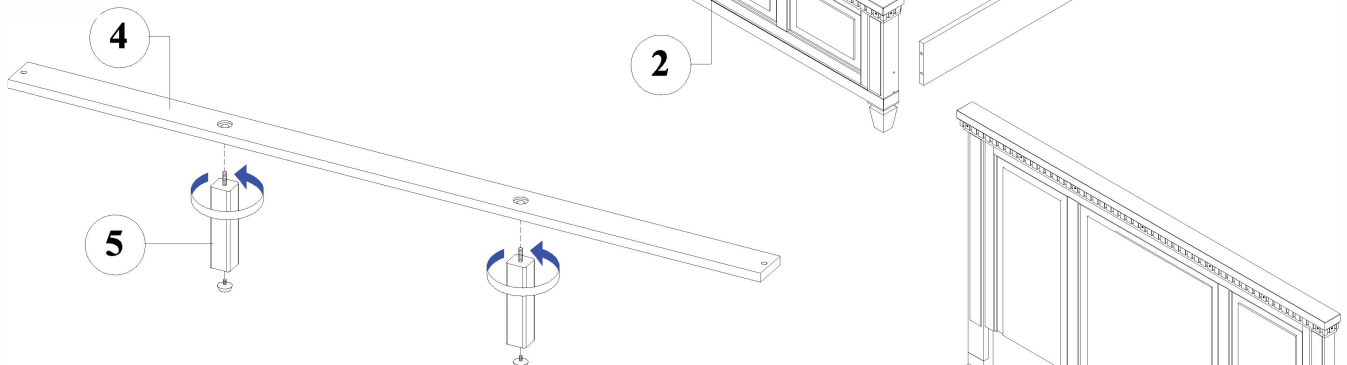

STEP-3

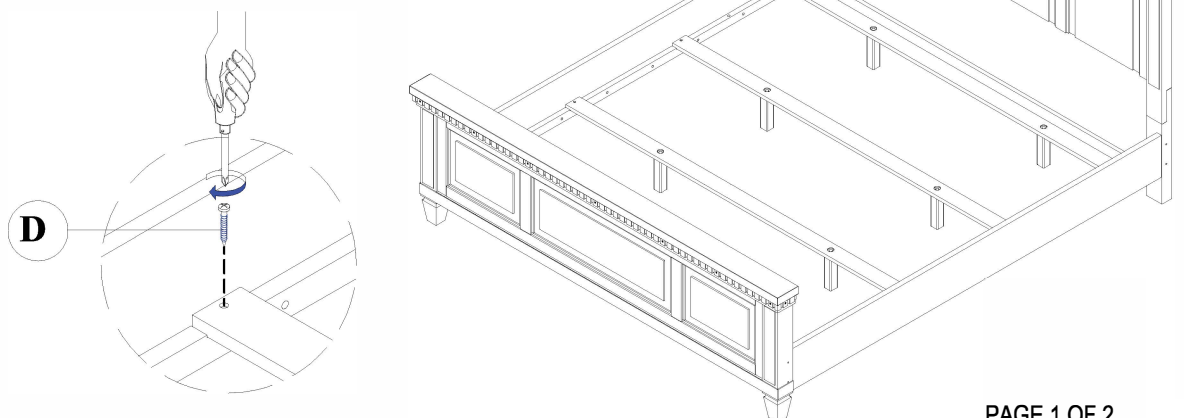

ASSEMBLY INSTRUCTION

6/6 PANEL HB/FB

6/6 PANEL RAILS

BEFORE YOU START ASSEMBLING,
PLEASE MAKE SURE ALL PARTS & HARDWARE ARE INCLUDE IN BOX :

CARTON-1

PART :

1. HEADBOARD PANEL
2. LEGS
3. STRETCHER

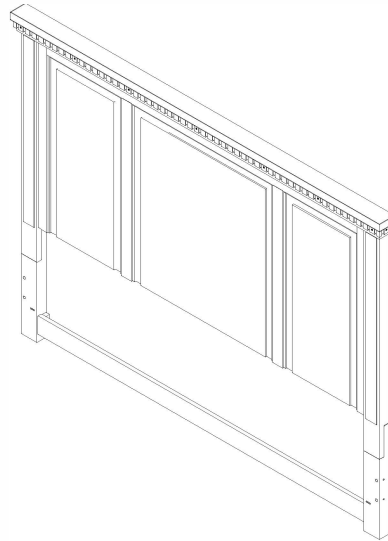

CARTON-2

PART :

1. FOOTBOARD
2. SLAT
3. SUPPORT SLAT

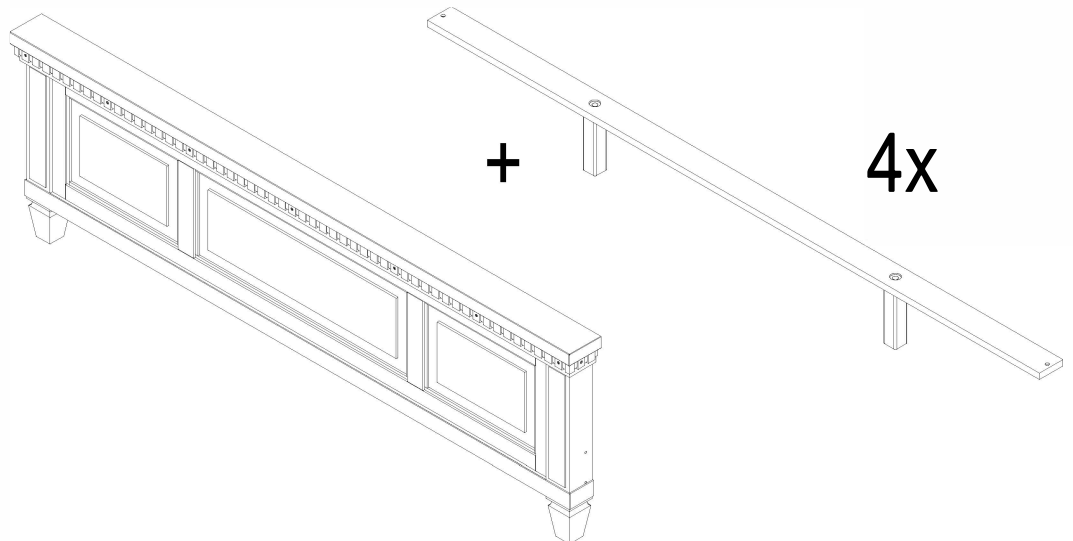

CARTON-3

PART :

1. RAILS 1 SET = 2 PCS

