

# Owner Manual



ARM CHAIR

# WARRANTY

We strive to offer high quality product and we also try our best to satisfy each customer that order from us, no matter on products or services as needed. Each customer receives a record of their order, such as the order number or item receipt. For any items that are out of warranty period, you may still be able to purchase the replacement parts from our company if they are available.

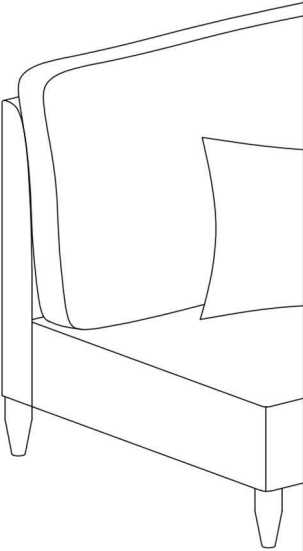

# MAINTENANCE AND WARNING

Please read the manual thoroughly  
before you start installing.

Please keep the product away from  
sharp object.

Packaging and small parts may have  
chocking hazard, please keep them away  
from children and pets.

Please clean the product according to each  
clean code, check the product description  
for more information.

Please keep the product away from  
fire.

If you have any other questions, please  
contact us, we will be glad to help you out.

If the product is placed under direct  
sunlight, the pattern or color might fade  
away overtime.

Check the product periodically to make  
sure everything is secured and tightened.

Always use proper tools for installation.

Do not jump on the product.

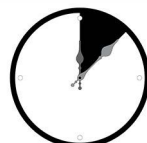

# PRODUCT DESCRIPTION

Rearrange the sections to fit any space or occasion. Whether you need a cozy loveseat or a spacious lounge, this sofa adapts effortlessly.

Smooth, velvety, and dirt resistant, the premium corduroy upholstery adds warmth and elegance while ensuring easy maintenance.

High density foam and durable springs create a plush yet supportive seating experience that holds its shape over time.

Built with a solid wood structure, this sofa offers long lasting durability and a strong weight bearing capacity.

Keep your sofa looking fresh with machine washable cushion covers, making cleaning hassle free.

# EXPLODED VIEW

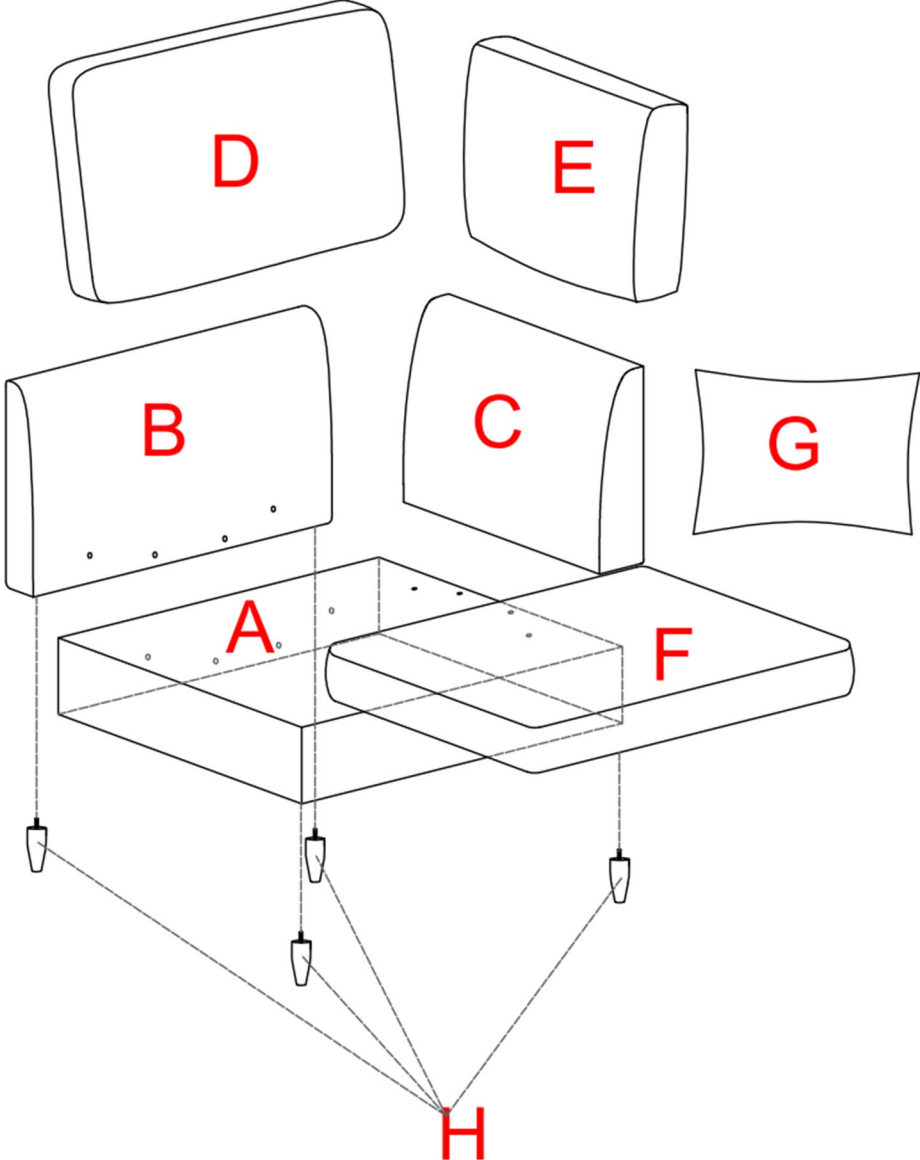

# PARTS

A\*1

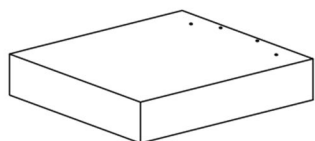

SOFA FRAME

B\*1

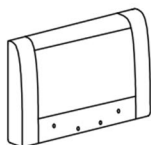

BACK FRAME

C\*1

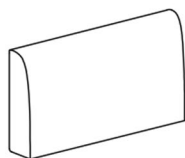

ARMREST FRAME

D\*1

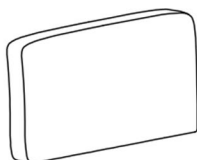

BACK CUSHION

E\*1

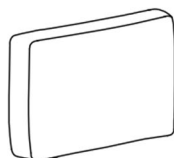

ARMREST CUSHION

F\*1

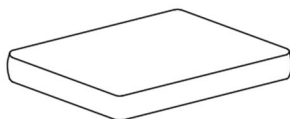

SEAT CUSHION

G\*1



PILLOW

# HARDWARE

## TOOL LIST

NOTE: Designated with (★) We provide additional spare parts in the hardware package

H\*4



Legs

I\*1

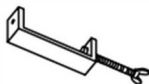

Metal buckle

J\*8



★ Screw&shim&Hex nuts  
One of them is a backup

K\*1

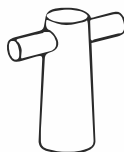

Heagon socket  
wrench

Please make sure all hardware & packing material fitting the list. Especially some small accessories may be missing during transportation. Please contact us if you have any question.

# step 1 ---Cut the plastic air compression bags

After taking out the cushions (F&D) from the air compression bags, please allow them to recover for a period of time. It may take up to 48 hours to fully recover. You can gently slap on them to speed up the process.

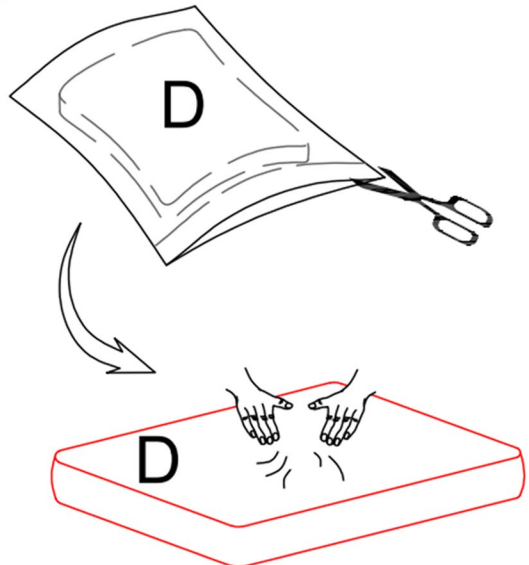
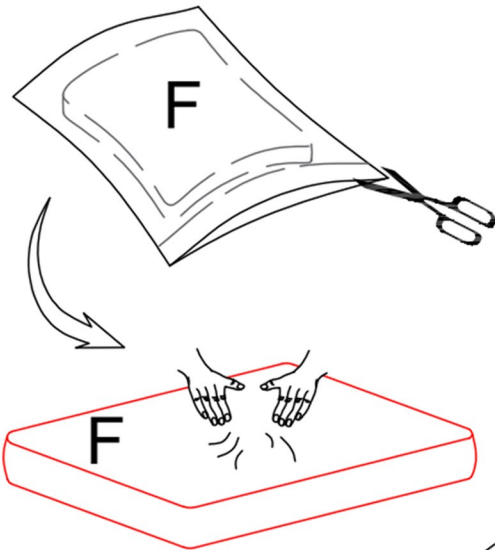

# step 2 ---Install the Legs (H)

Screw the legs (H) into each hole on seat frame (A) and back frame (B) as shown, make sure they are tightened.

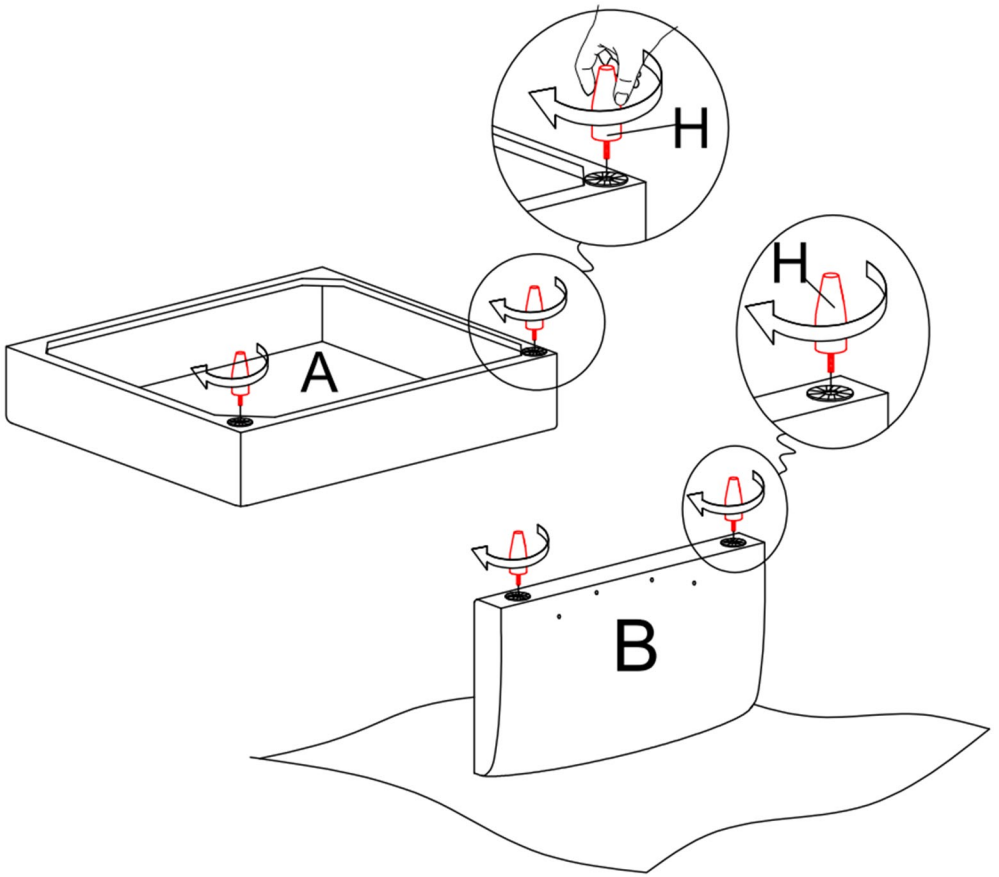

# step 3 ---Install the Screws (J)

Align the screws into the pre-drilled holes on the backrest (B), then use hand to twist the screws (J) for 1/3 of their length as shown.

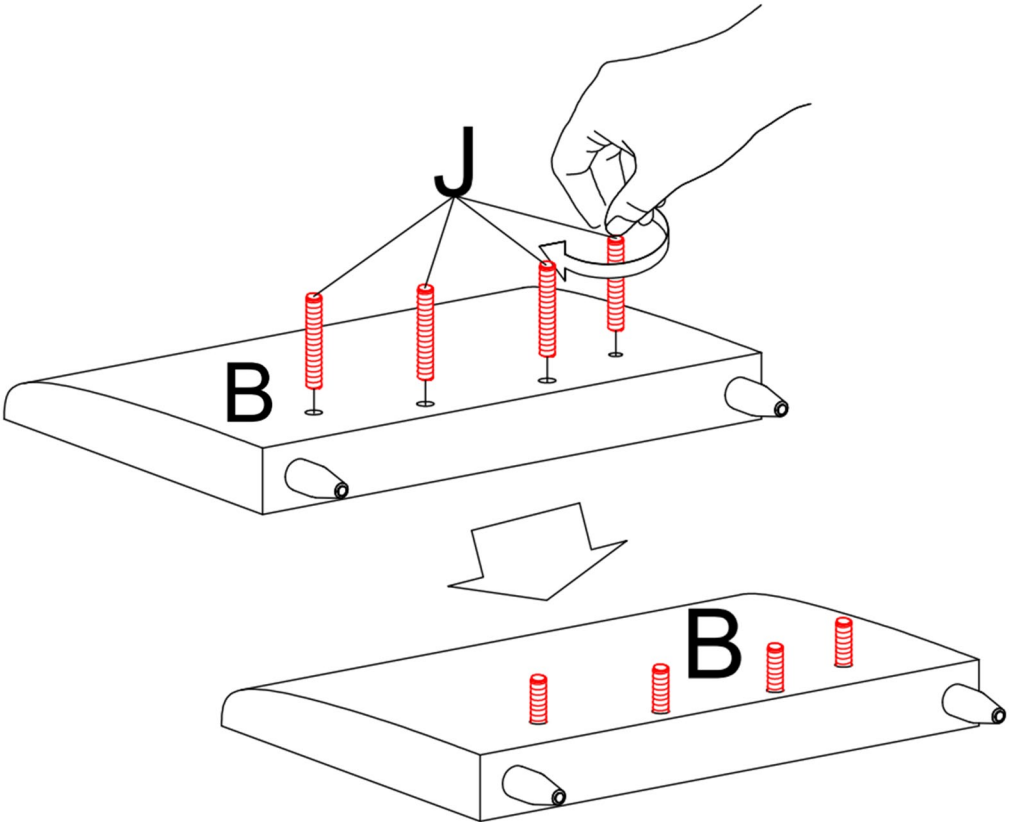

# step 4 ---Install the seat frame (A)

First, align the designated holes on the seat frame (A) with the screws on the backrest (B) from the last step as shown. Then place one shim and one hex nut (J) onto each screw (J), use the hexagon socket wrench (K) provided to tighten both nuts.

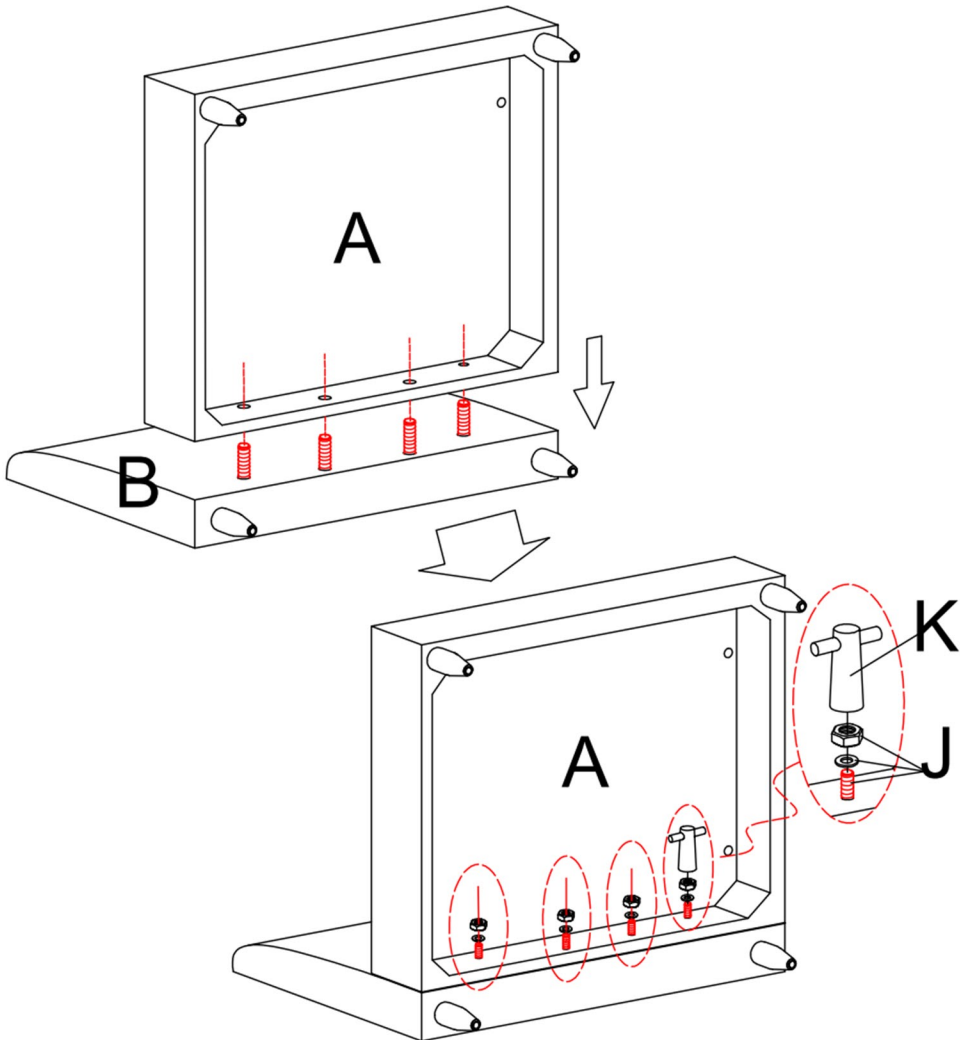

# step 5 ---Install the Screws (J)

Align the screws into the pre-drilled holes on the armrest (C), then use hand to twist the screws (J) for 1/3 of their length as shown.

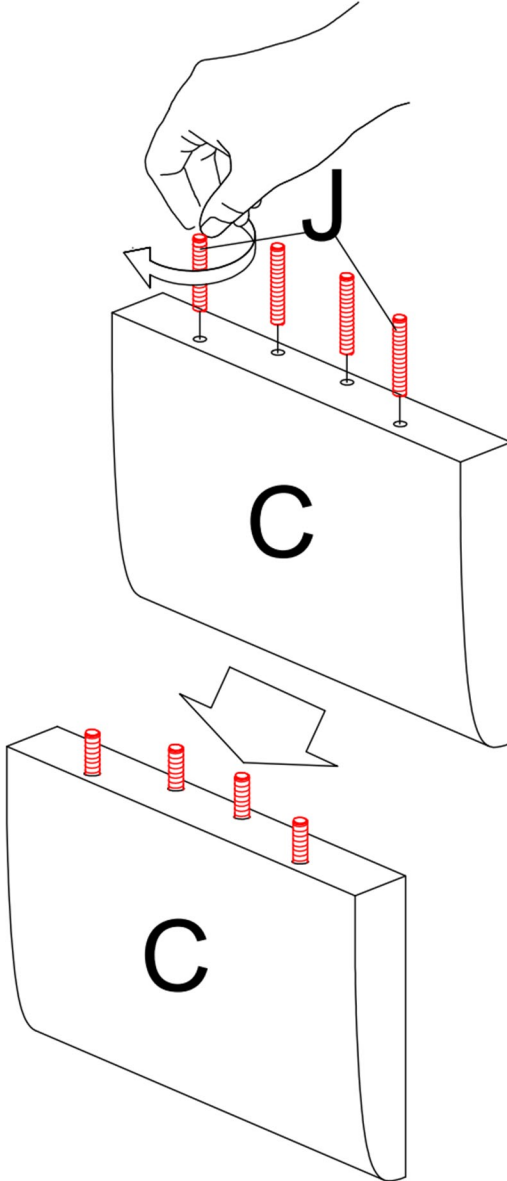

# step 6 ---Install the armrest (C)

First, align the designated holes on the seat frame (A) with the screws on the armrest (C) from the last step as shown. Then place one shim and one hex nut (J) onto each screw (J), use the hexagon socket wrench (K) provided to tighten both nuts.

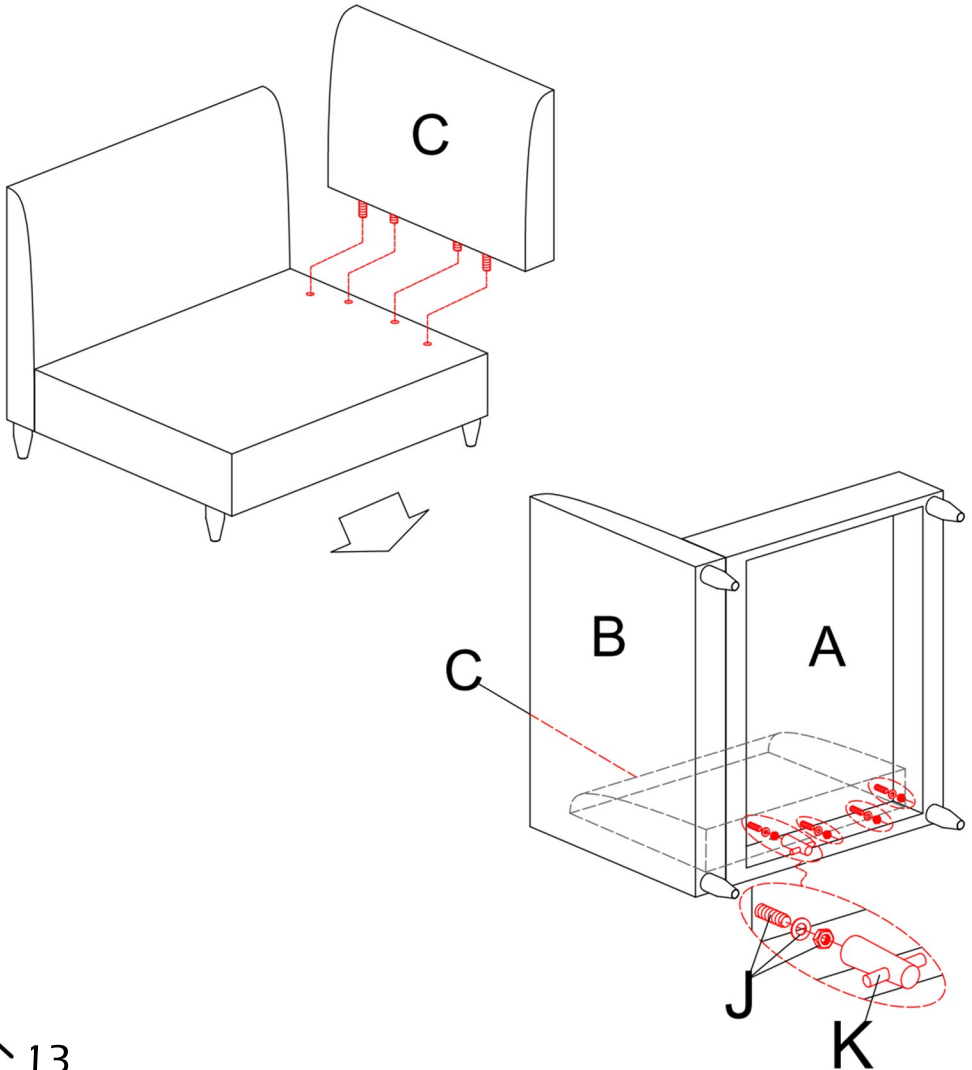

# step 7

In the step 6, if the screw assembled on the armrest is difficult to insert into the assembly hole on the seat frame, you can loosen the screw used in the previous step to assemble the backrest, and then insert the screw on the armrest wooden frame into the assembly hole on the seat frame, and then insert the gasket, and then screw on the nut. Before all screws are tightened, keep the side of the backrest flat where it meets the surface of the armrest before tightening all screws.

When you screw, check each screw repeatedly to ensure that each screw can not be screwed until. If the backrest and armrest wobble, use the tools in the parts kit to completely tighten the assembly screws.

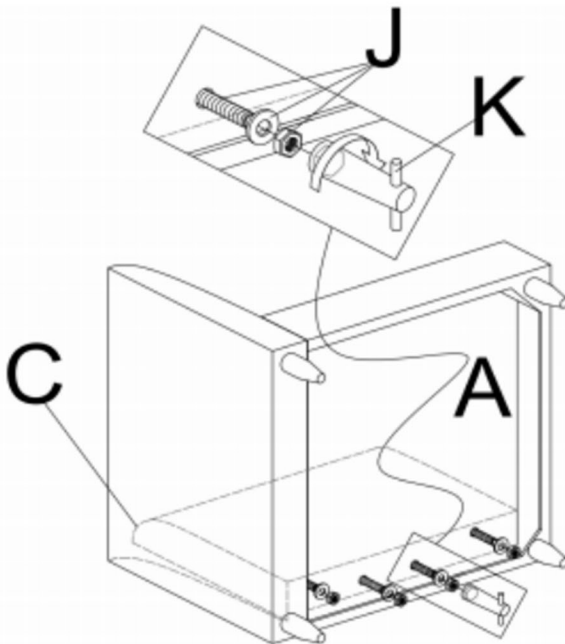

# step 8 ---Place the seat cushion ( F )

Place the seat cushion ( F ) on to the sofa.

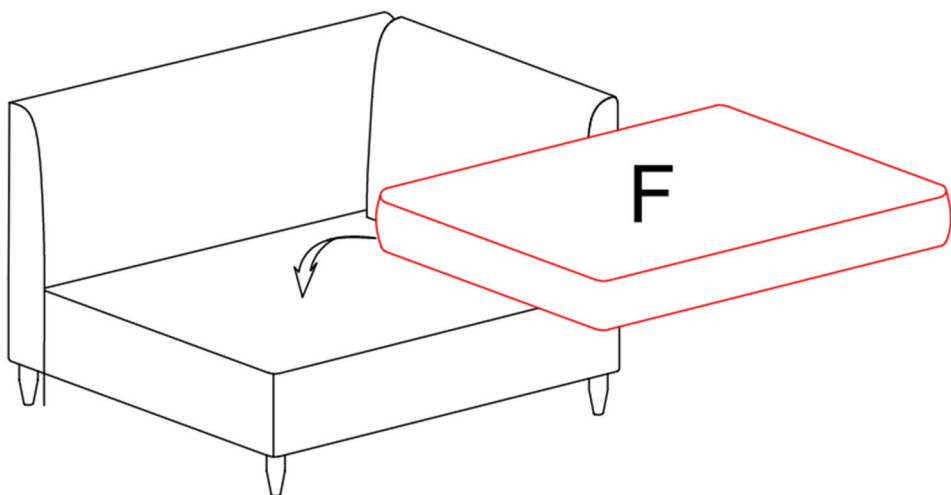
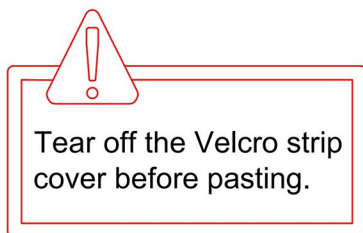
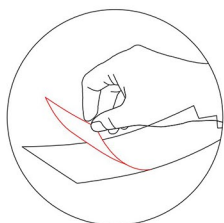

# step 9 ---Place the back cushion (D)& armrest cushion (E)

Place the back cushion (D) on to the sofa.

Place the armrest cushion (E) on to the sofa.

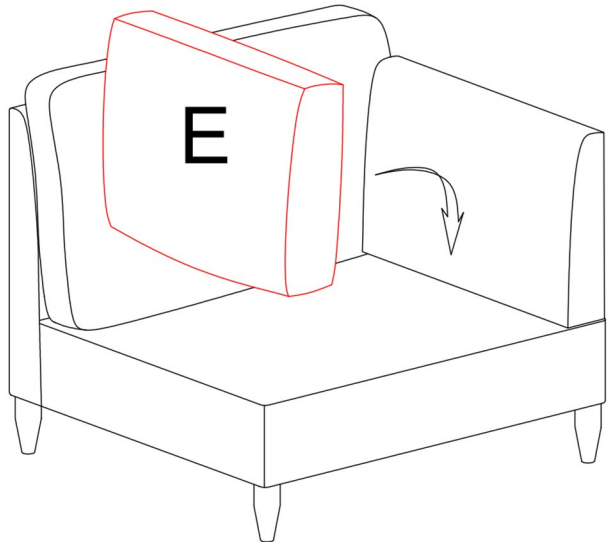
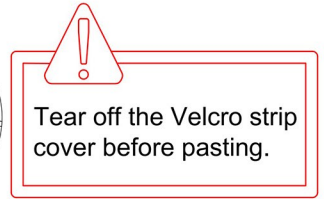
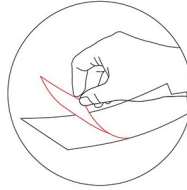
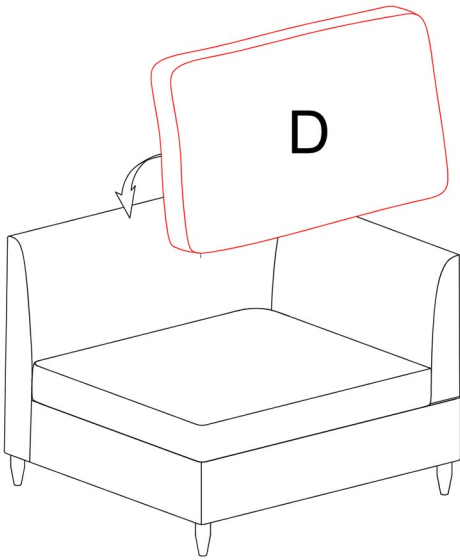

# step 10 ---Place the Pillow (G)

Place the pillow (G) on to the sofa.

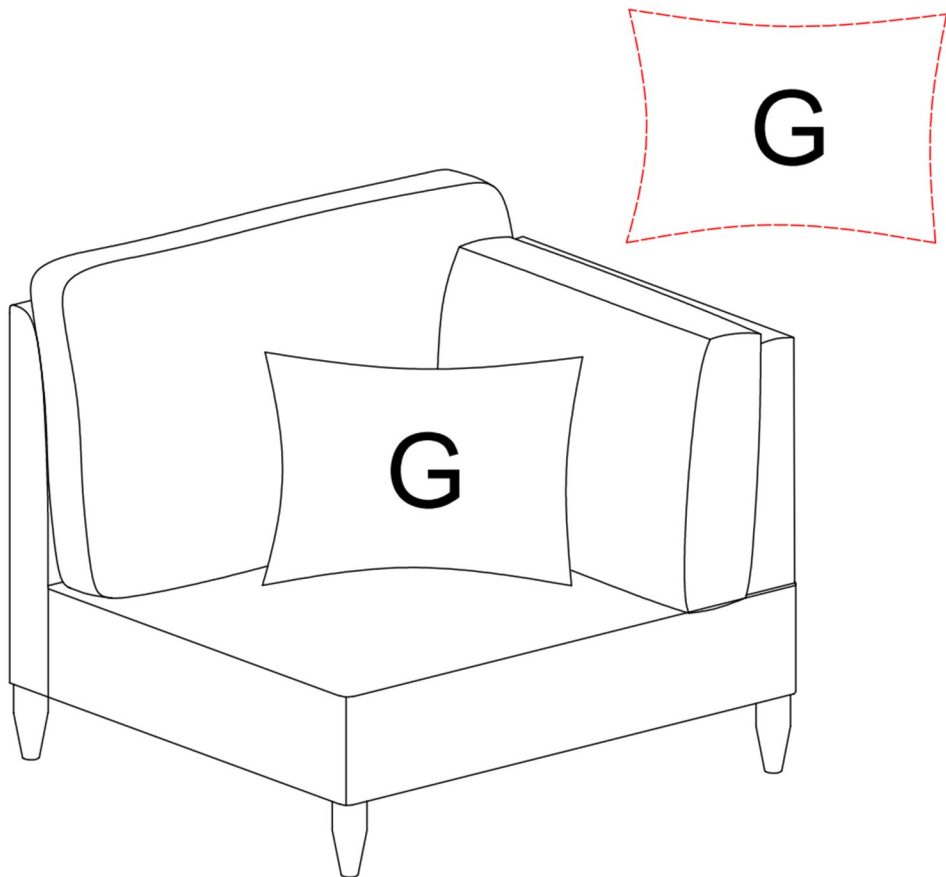

# step 11 ---Install the metal hook

There is a metal buckle inside the carton as a free part.

If you only purchased single part of the sofa, this buckle will not be useful.

If you want to be combined with other sofa components (ottoman, chair ,chaise etc), this buckle can be used. Just use this buckle to fix two parts together from the bottom to prevent displacement while using the products.

