

# INSTALLATION MANUAL

## STORAGE CABINET

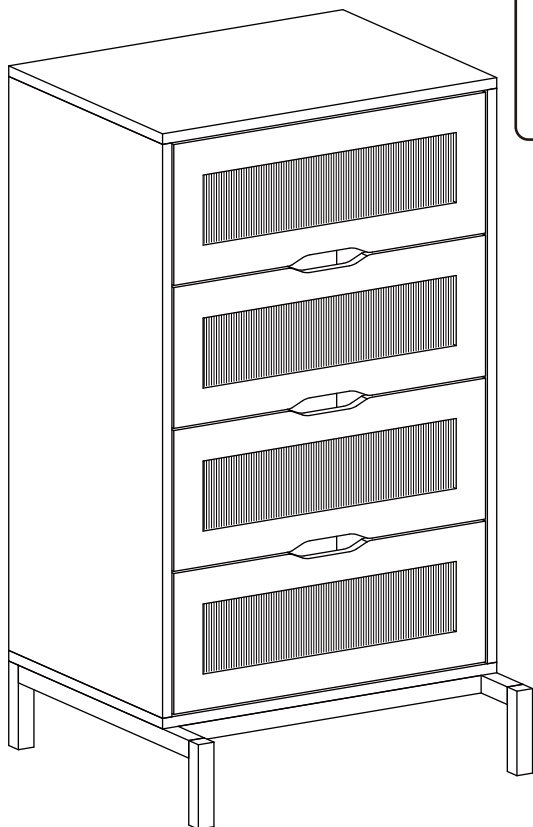

### **WARNING**

**INSTALLATION REQUIRES TWO ADULTS,  
KEEP AWAY FROM CHILDREN TO  
PREVENT ANY INJURY.**

Tools Required

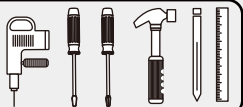

updated on 08/30/2024

# SUMMARY

INTRODUCTION

PAGE 2

TIPS AND WARNINGS

PAGE 3

PARTS LIST

PAGE 5

INSTALLATION STEPS

PAGE 7

# INTRODUCTION

Before using the product ,please read this manual carefully and then assemble it.

To avoid any injury or damage to the product,please follow below safety rules.

- Product should to be installed in a dry,flat place indoor.
- Assembly & movement: minimum 2 adults - heavy and fragile product.
- Make sure all screws in the part list included in the hardware package before assembly.
- In the event of a missing items,contact the seller within 48 hours of receiving the product.



## ATTENTION



This product is for household use only! And not for commercial use.

Do not use this product for any other over expected purpose. To any commercial use, public or institutional, disclaims all liability and cancels all guarantees.

## TIPS AND WARNINGS:

- Do not lean on the shoe cabinet.
- Do not store in a damp room or outdoor.
- Beware of the risks of pinching and puncturing during installation.

### **Maintenance :**





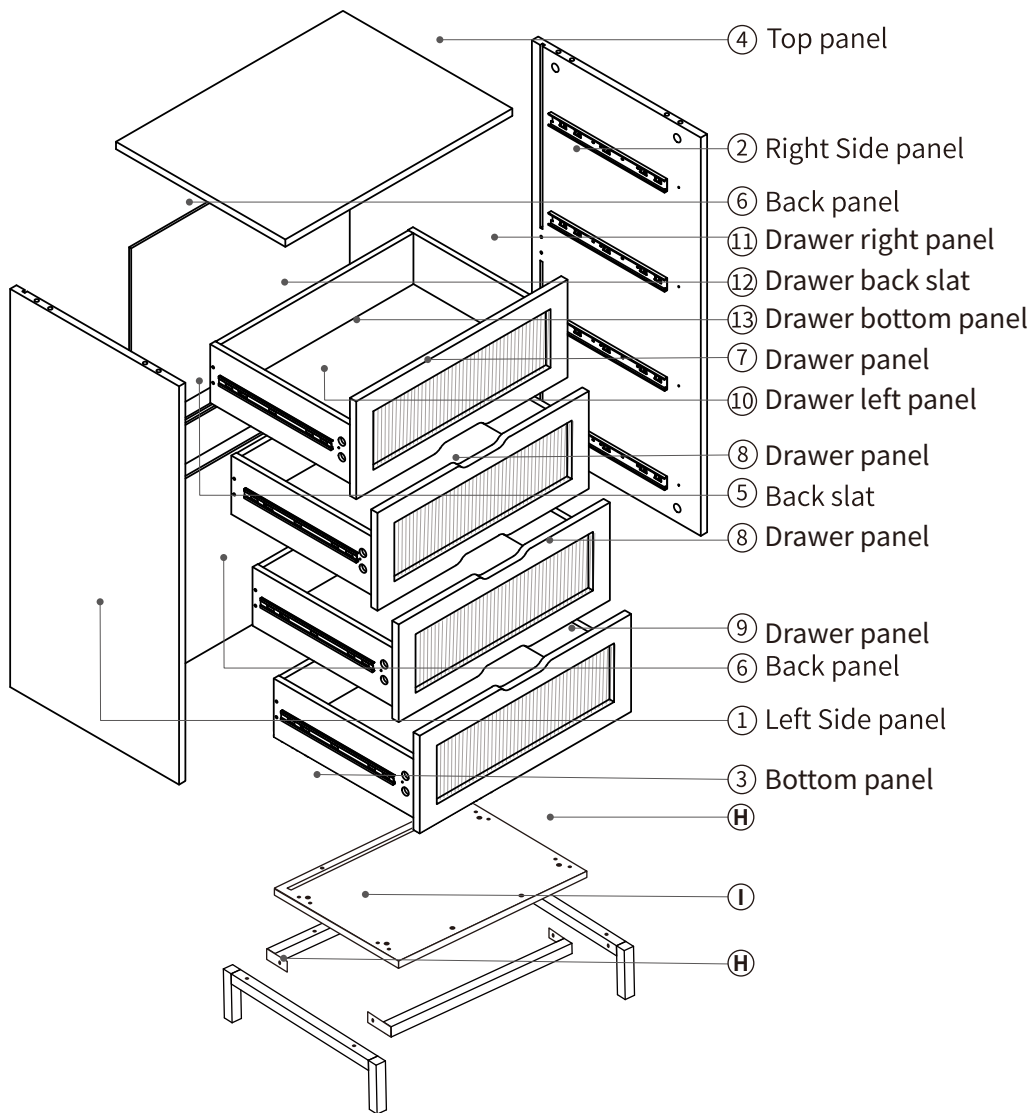

Cleaning with a dry cloth.



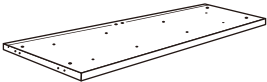
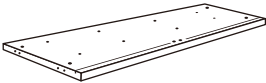
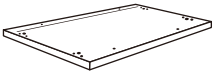
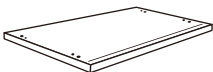

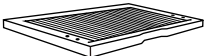
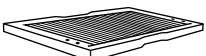
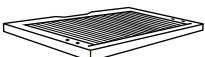





Far away from water or wet things







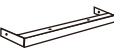



# PART LIST

Illustration picture for reference only

NO.	DESCRIPTION	QTY	SIZE (mm)	ILLUSTRATION
①	Left Side panel	1	815x399x15	
②	Right Side panel	1	815x399x15	
③	Bottom panel	1	536x400x15	
④	Top panel	1	536x400x15	
⑤	Back slat	1	505x80x15	
⑥	Back panel	2	516x378x5	
⑦	Drawer panel	1	499x200x15	
⑧	Drawer panel	2	499x200x15	
⑨	Drawer panel	1	499x200x15	
⑩	Drawer left panel	4	340x120x12	
⑪	Drawer right panel	4	340x120x12	
⑫	Drawer back slat	4	455x120x12	
⑬	Drawer bottom panel	4	466x338x5	

NO.	ILLUSTRATION	QTY	SIZE (mm)
Ⓐ		28	
Ⓑ		16	Φ15x10
Ⓒ		12	Φ15x12
Ⓓ		16	Φ3.5x30
Ⓔ		32	Φ3.5x12
Ⓕ		8	
Ⓖ		8	
Ⓗ		2	398x120
Ⓘ		2	482x75x25
Ⓙ		4	Φ6x12

NO.	ILLUSTRATION	QTY	SIZE (mm)
Ⓚ		8	Φ6x40
Ⓛ		8	Φ8x30
Ⓜ		12	Φ4x16
Ⓝ		12	
Ⓞ		4	Φ3.5x15
Ⓟ		4	Φ3.5x40
Ⓠ		4	
Ⓡ		4	
Ⓢ		2	

# INSTALLATION STEPS

Please read the instructions carefully before assembling the cabinet.

Two adults are required for assembly of this product on a clean, flat surface instead of a rough surface.

## STEP 1 | Drawer Assembly

**Attention:**

Make sure all screws locked tightly.

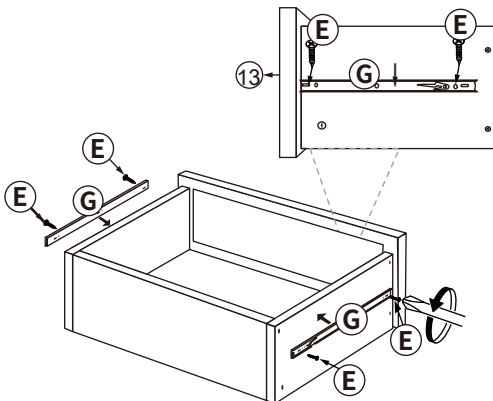
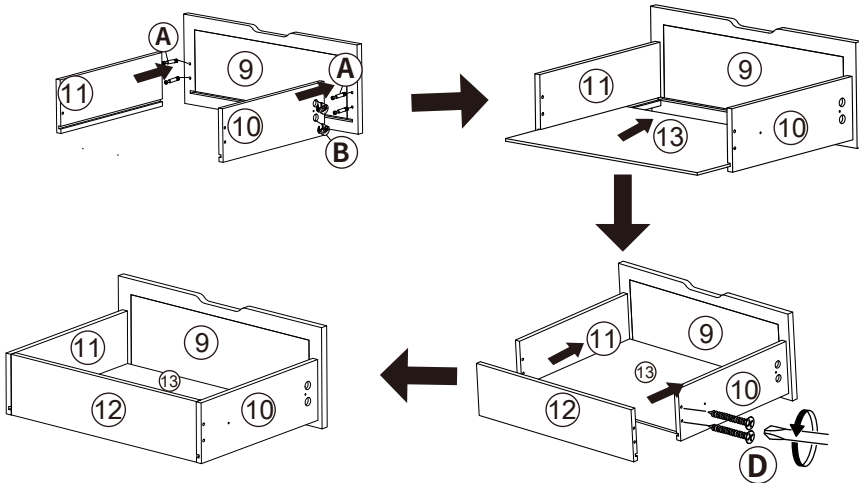
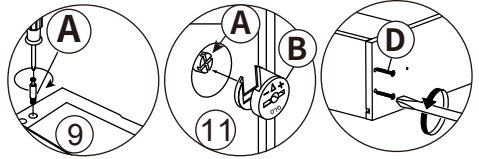

**Attention:**

Make sure all screws locked tightly.

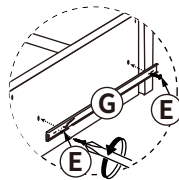

## STEP 2 | Assemble the guide rail on the side panel

**Attention:**

Make sure all screws locked tightly.

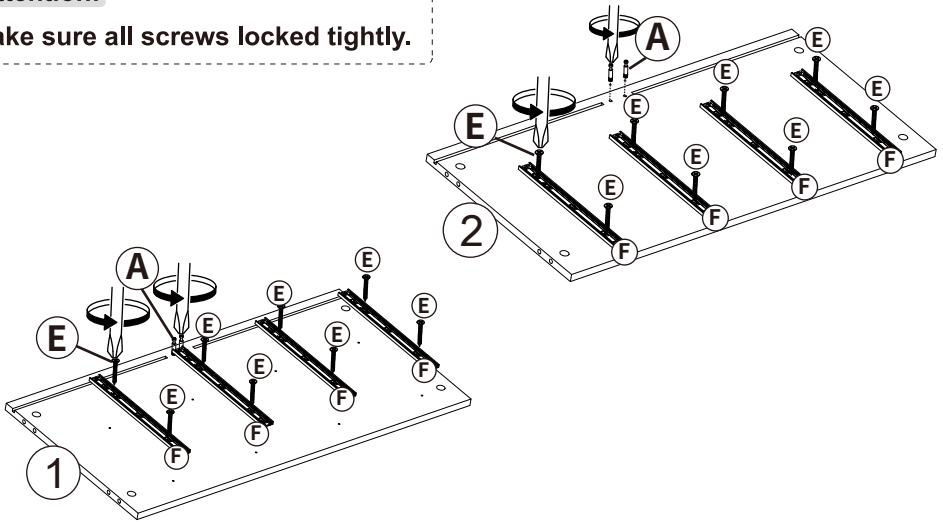

## STEP 3 | Assemble the iron frame and bottom panel

**Attention:**

Make sure all screws locked tightly.

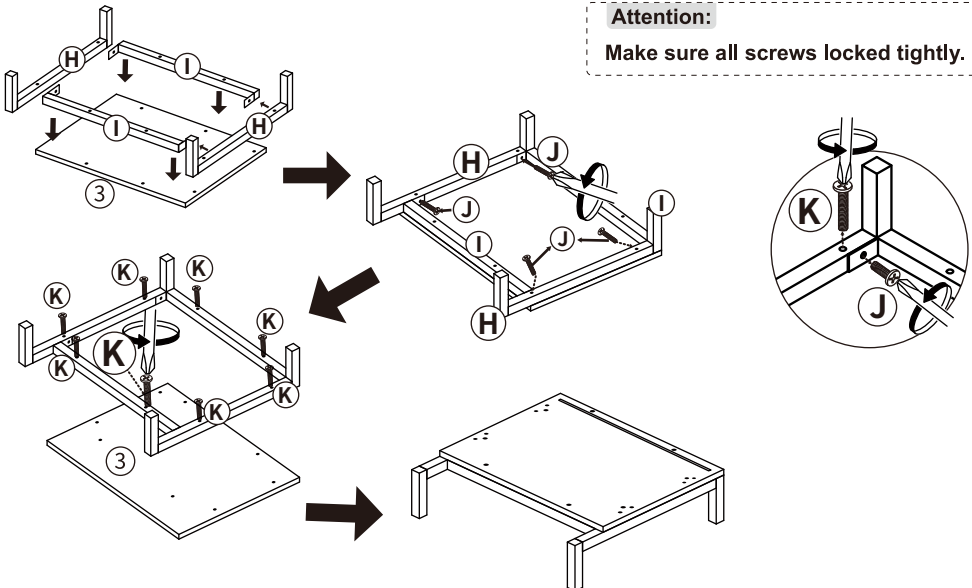

## STEP 4 | Assemble the side panel and back panel

**Attention:**

Make sure all screws locked tightly.

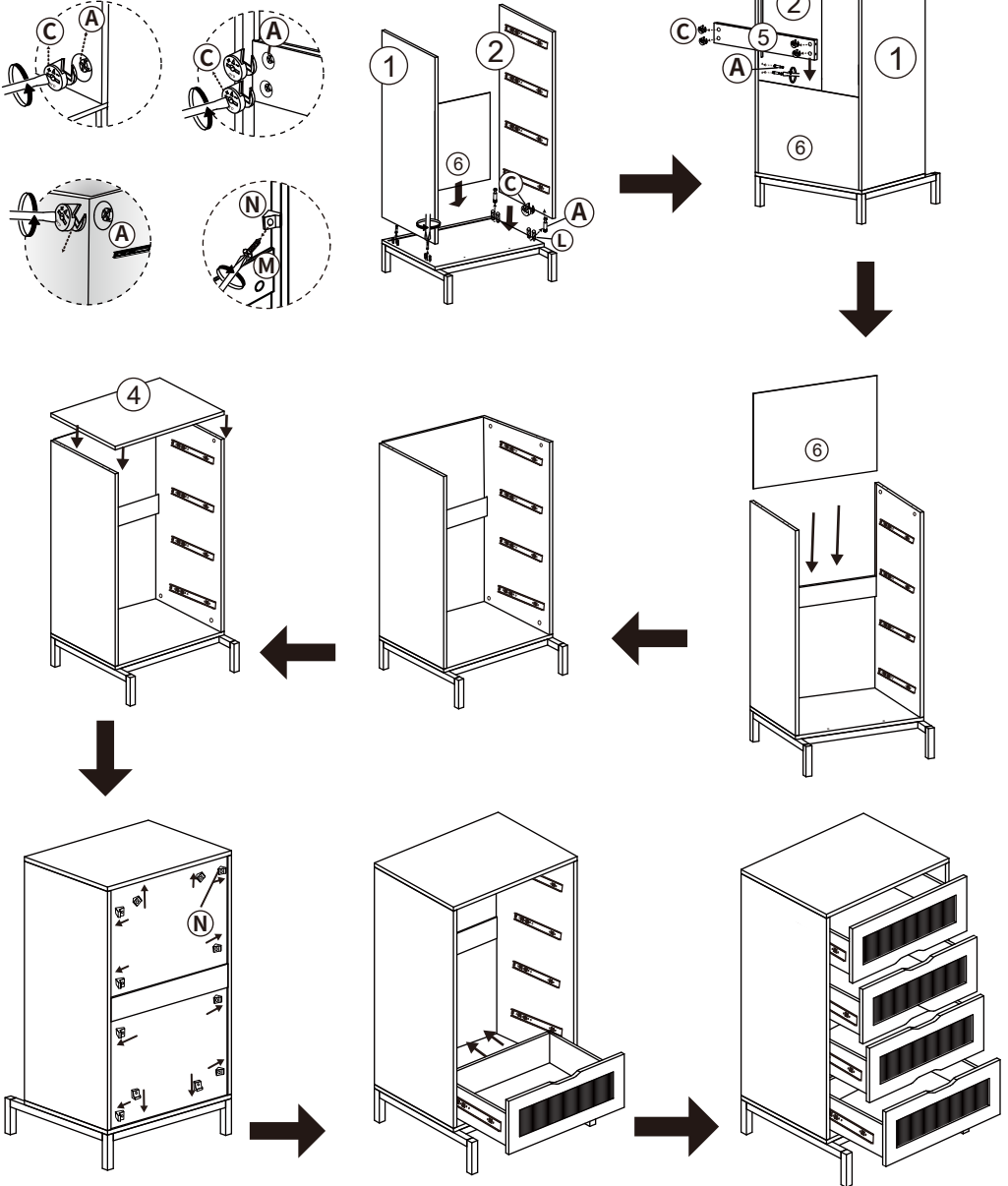

## STEP 5 | Install the anti-falling device

### ⚠ ATTENTION ⚠

This unit must be fixed to a solid wall by falling prevention screws. Failure to do so may result in a risk of the cabinet falling over and possible injury/damage to persons or property.

Note: to prevent it from collapsing, the tie-down straps need to be fastened after tightening the screws

### ⚠ WARNING



Children have died from furniture tipover. To reduce the risk of furniture tipover:

- ALWAYS install Anti-tip device provided.
- NEVER put a TV on this product.
- NEVER allow children to stand, climb or hang on any drawers, doors, or shelves.
- NEVER open more than one drawer at a time.
- Place heaviest items in the lowest drawers.

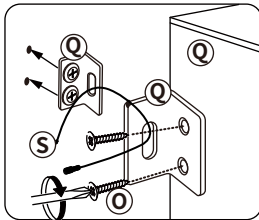

Front View

