

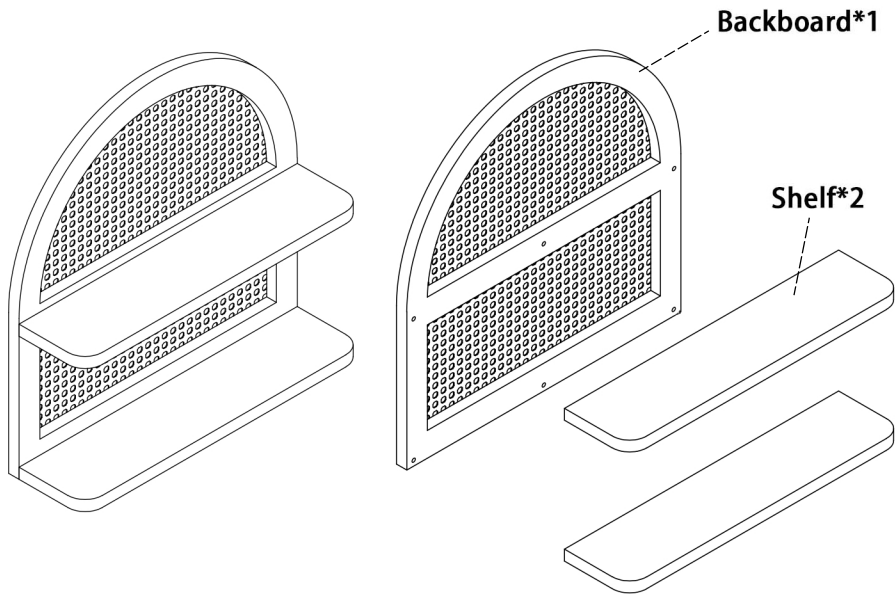





Instruction Manual



Hardware Parts	A 	B 	C 	D 	E 	 1/4" (6mm) self-provided tools drill bit: 1/4" (6mm)
----------------	--	--	--	--	--	---

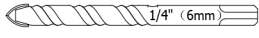
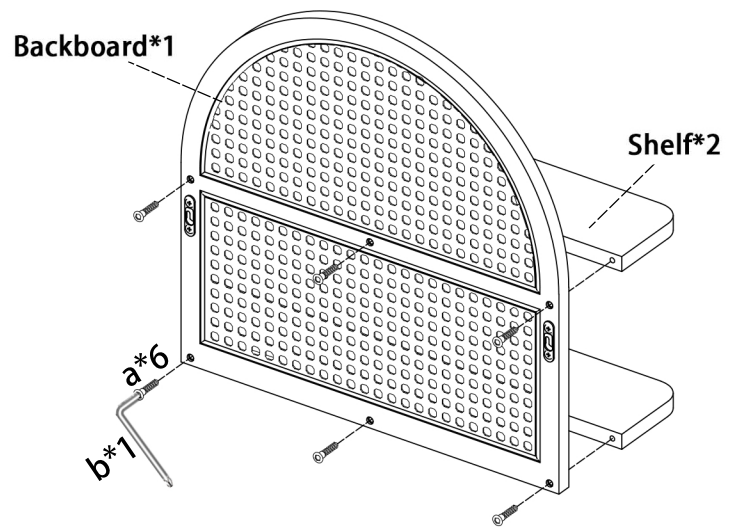

Installation

Measure the distance with a ruler.

Mark the place where you want to install the shelf and check with a level.

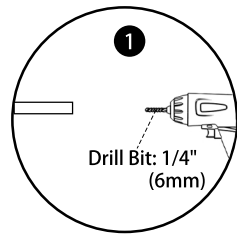
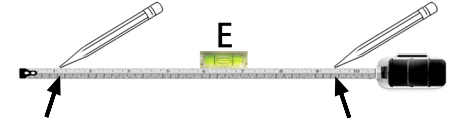
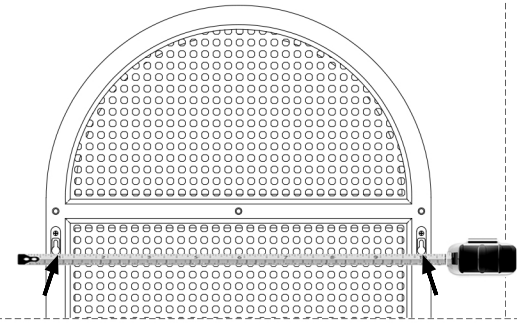

Drill 6 mm holes

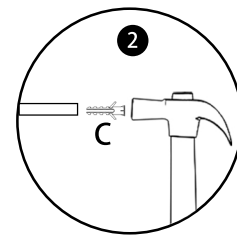

Punch the expansion nails

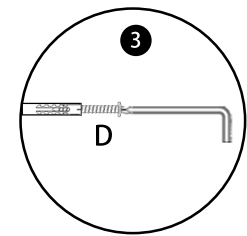

Punch the screws

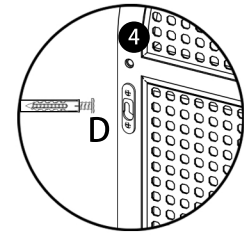

Hang the rattan shelf

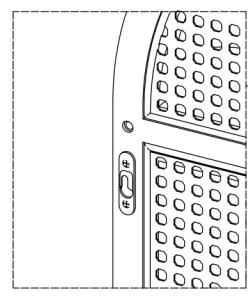

Enlarge image

