

COUNTER CHAIR ASSEMBLY INSTRUCTION

Thank you for purchasing this quality product. Be sure to check all packing material carefully for small parts which may have come loose inside the carton during shipment. Separate, identify and count all parts and hardware. Compare with the parts list to be sure all parts are present.

IMPORTANT : PLEASE READ INSTRUCTION BEFORE STARTING THE ASSEMBLY.

"DO NOT TIGHTEN SCREWS UNTIL COMPLETELY ASSEMBLED"

"DO NOT OVERTIGHT ANY HARDWARE"

WARNING : SMALL PARTS AND HARDWARE NOT FOR CHILDREN UNDER 3 YEARS. ADULT ASSEMBLY REQUIRED.

TABLE OF CONTENTS

HARDWARES LIST	PAGE 2
PARTS LIST	PAGE 3
PARTS' LOCATION	PAGE 4
ASSEMBLY STEPS	PAGE 5 - 6
ASSEMBLY COMPLETED	PAGE 7

ASSEMBLY TOOLS REQUIRED

1. Screwdriver (not provide)

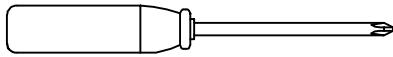

2. Hammer (not provide)

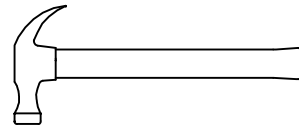



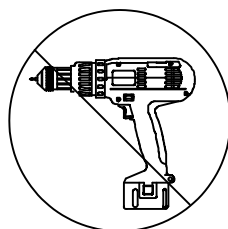



Skip the power drill this time.

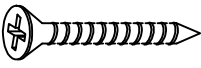

COUNTER CHAIR ASSEMBLY INSTRUCTION

HARDWARES LIST



ITEM	DESCRIPTION	DRAWING	QTY
A	JCBC SCREW M6 x 35MM		4 PCS
B	JCBC SCREW M6 x 60MM		8 PCS
C	JCBC SCREW M6 x 80MM		8 PCS
D	SPRING WASHER M6 x 12mm		20 PCS
E	FLAT WASHER M6 x 19mm		20 PCS
F	CSK C/B SCREW (M4 x 38MM)		12 PCS
G	M4 ALLEN KEY (100MM)		1 PC

There are total TWO (2) packs of hardware packs.
 Each hardware pack includes the hardware for TWO (2) chairs.

COUNTER CHAIR ASSEMBLY INSTRUCTION

PARTS LIST

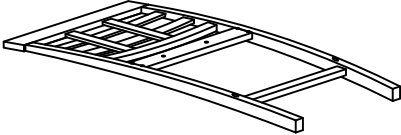
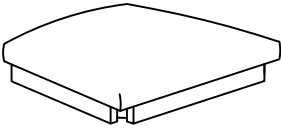
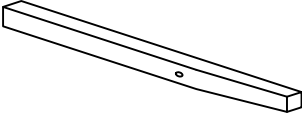
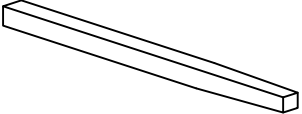
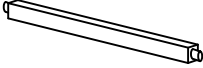
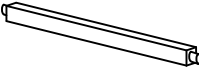
BOX 1

ITEM	DESCRIPTION	DRAWING	QTY
1	BACKREST		4 PCS
2	SEAT		4 PCS
3	RIGHT LEG WITH LABEL "R"		4 PCS
4	LEFT LEG WITH LABEL "L"		4 PCS
5	RIGHT STRETCHER WITH LABEL "R"		4 PCS
6	LEFT STRETCHER WITH LABEL "L"		4 PCS
7	FRONT STRETCHER		4 PCS

COUNTER CHAIR ASSEMBLY INSTRUCTION

PARTS ' LOCATION

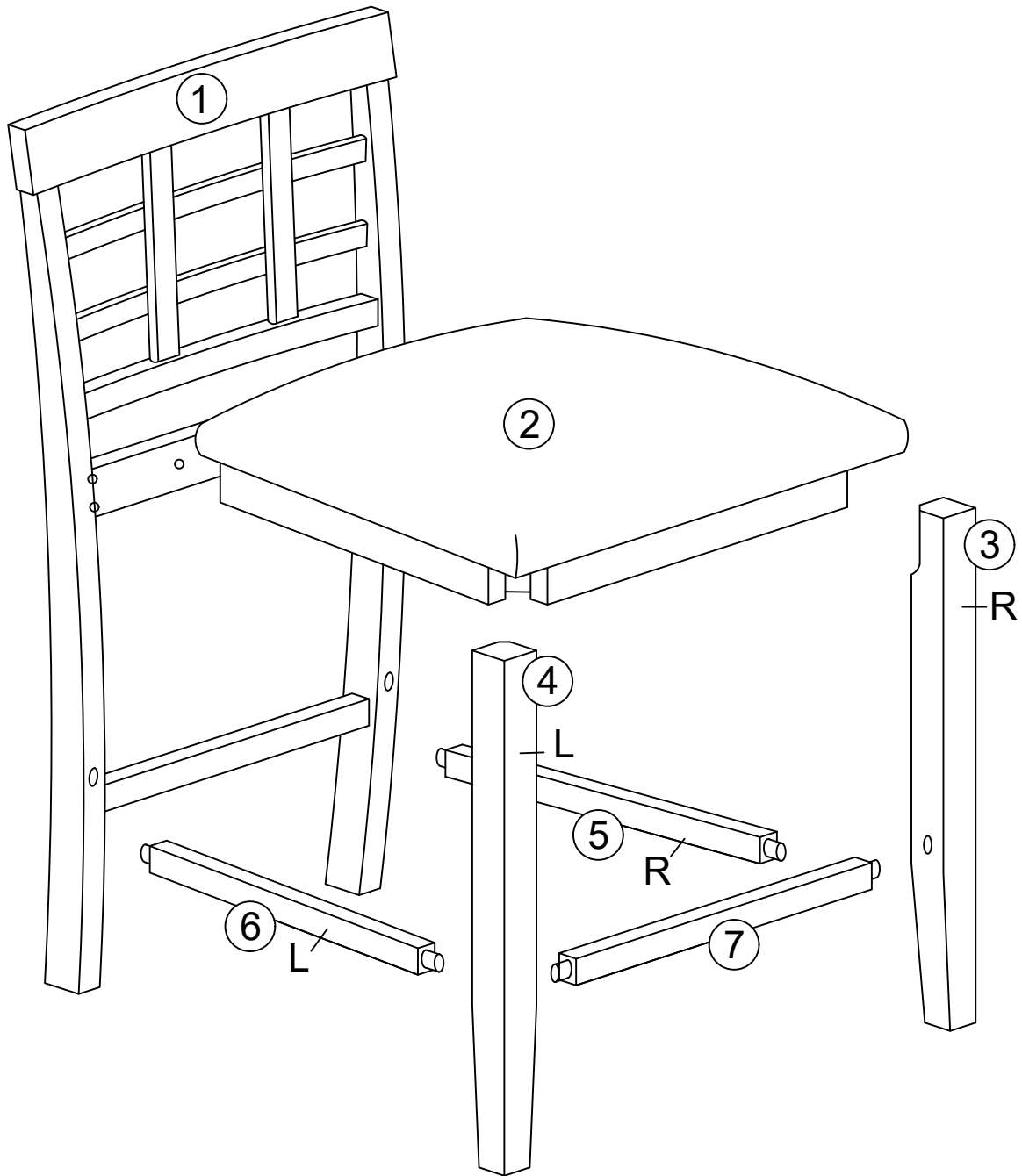

COUNTER CHAIR ASSEMBLY INSTRUCTION

STEP 3

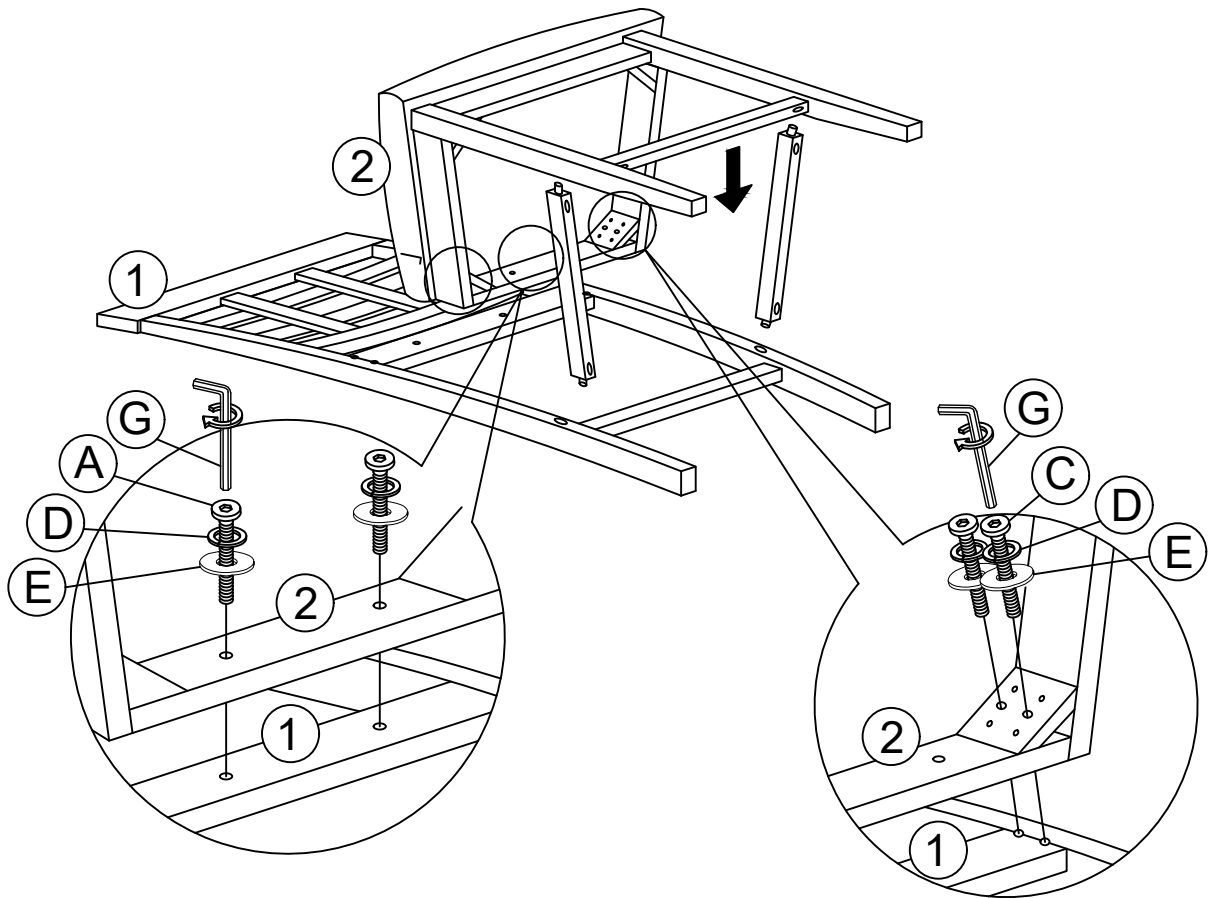

STEP 4

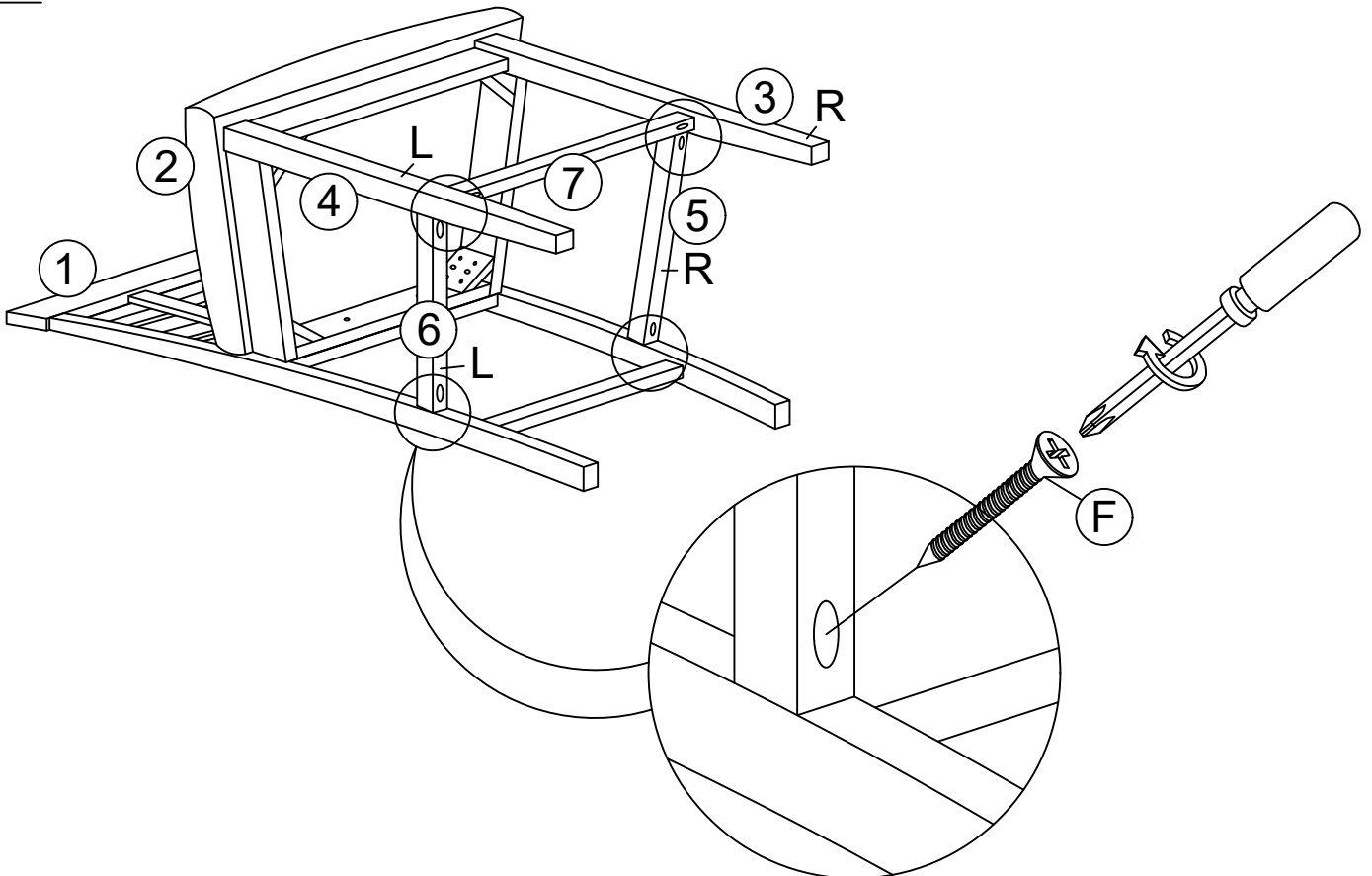

COUNTER CHAIR ASSEMBLY INSTRUCTION

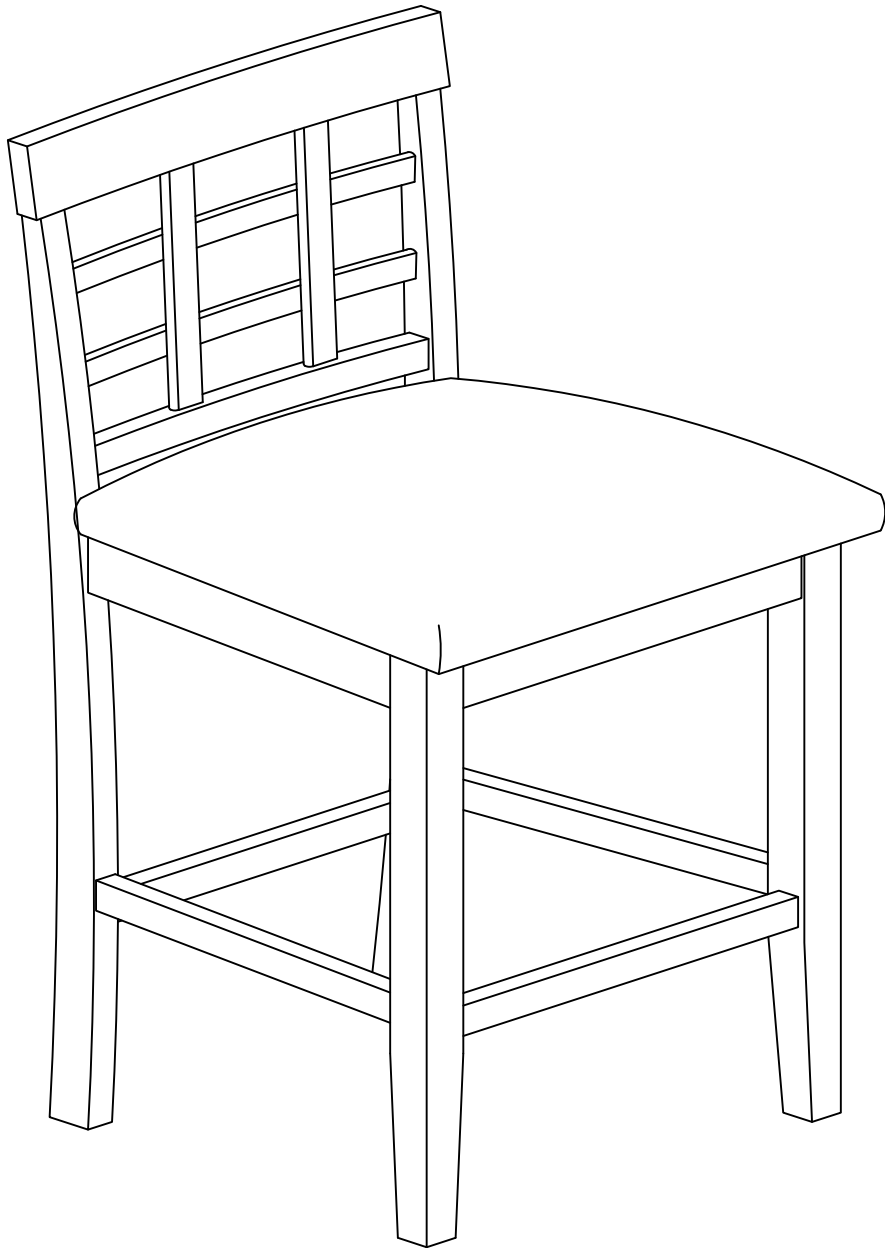

**ASSEMBLY
COMPLETED**