

# ASSEMBLY INSTRUCTION

## DINING CHAIR

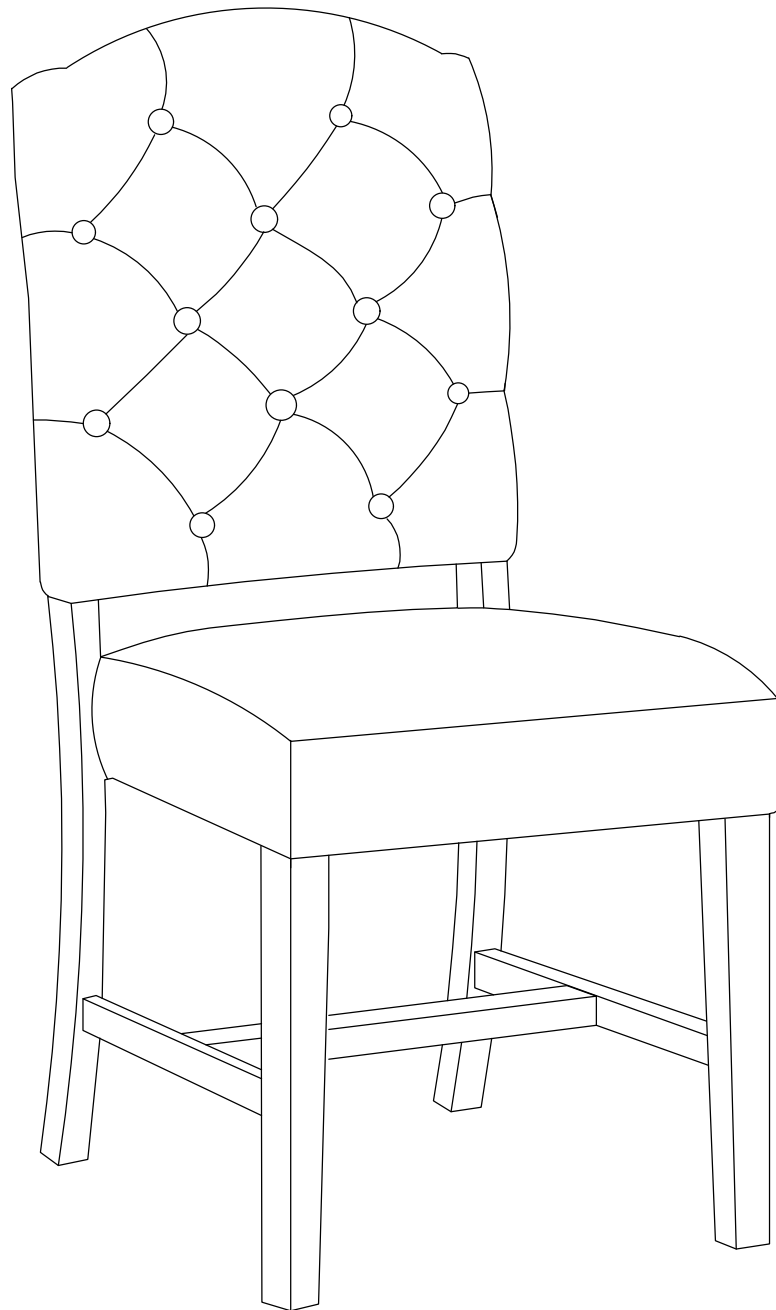

# ASSEMBLY INSTRUCTION

## DINING CHAIR

### IMPORTANT NOTE:

Please read these instructions fully before starting assembly:

1. Place all wooden parts on a clean and smooth surface such as a rug or carpet to avoid scratching the parts.
2. Kindly follow the assembly instructions step by step.
3. Do not tighten all screws and bolts until the table is fully assembled.
4. Unscrew the protective plastic supports from the metal insert of the table legs before assembly.
5. Parts of the assembly will be easier with 2 people.





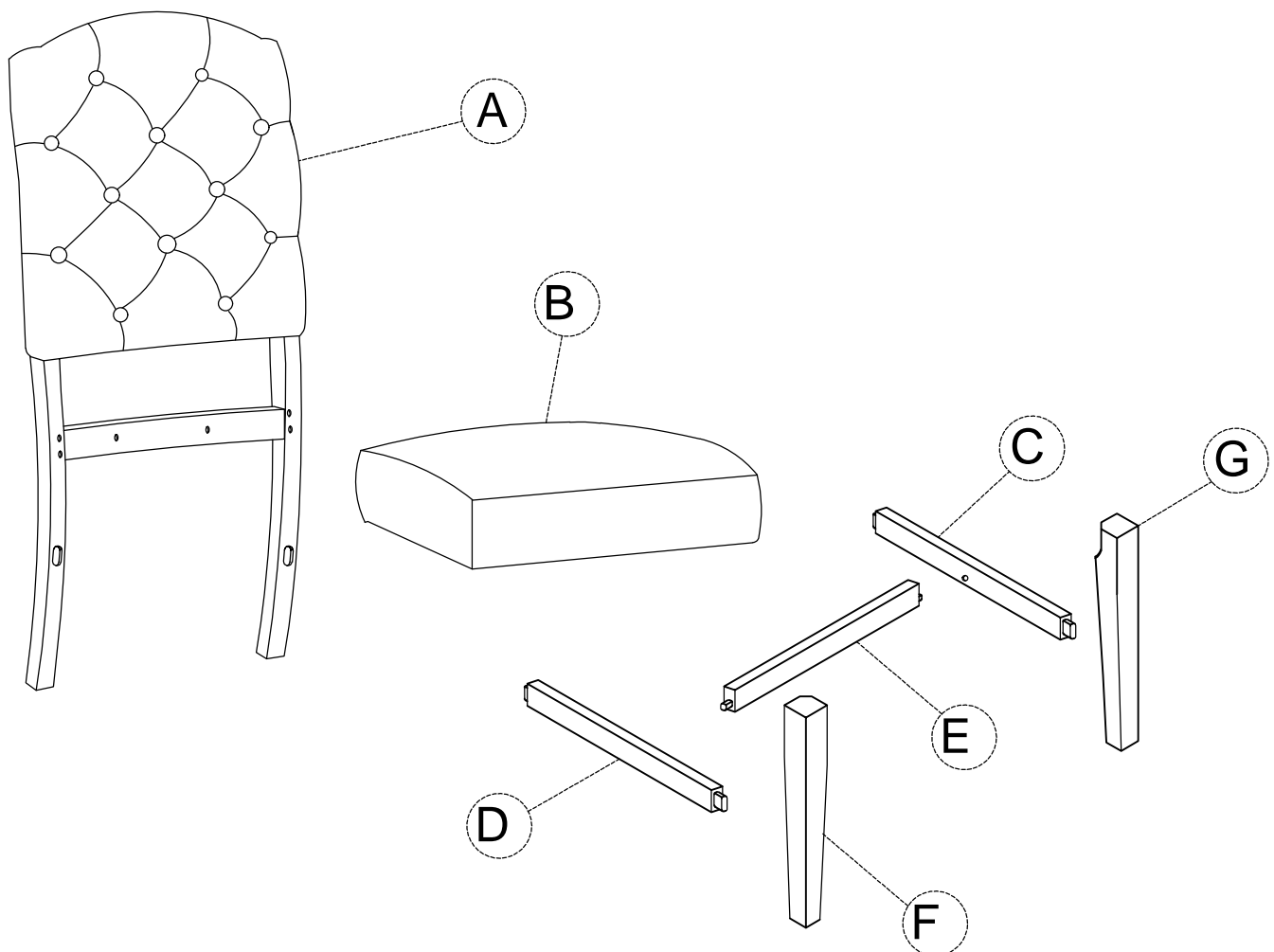





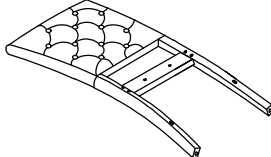

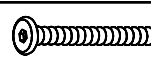
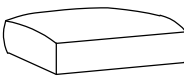
Care and maintenance:

Only clean using a damp cloth and mild detergent, do not use bleach or abrasive cleaners.







## Part List For One

## Hardware List For One

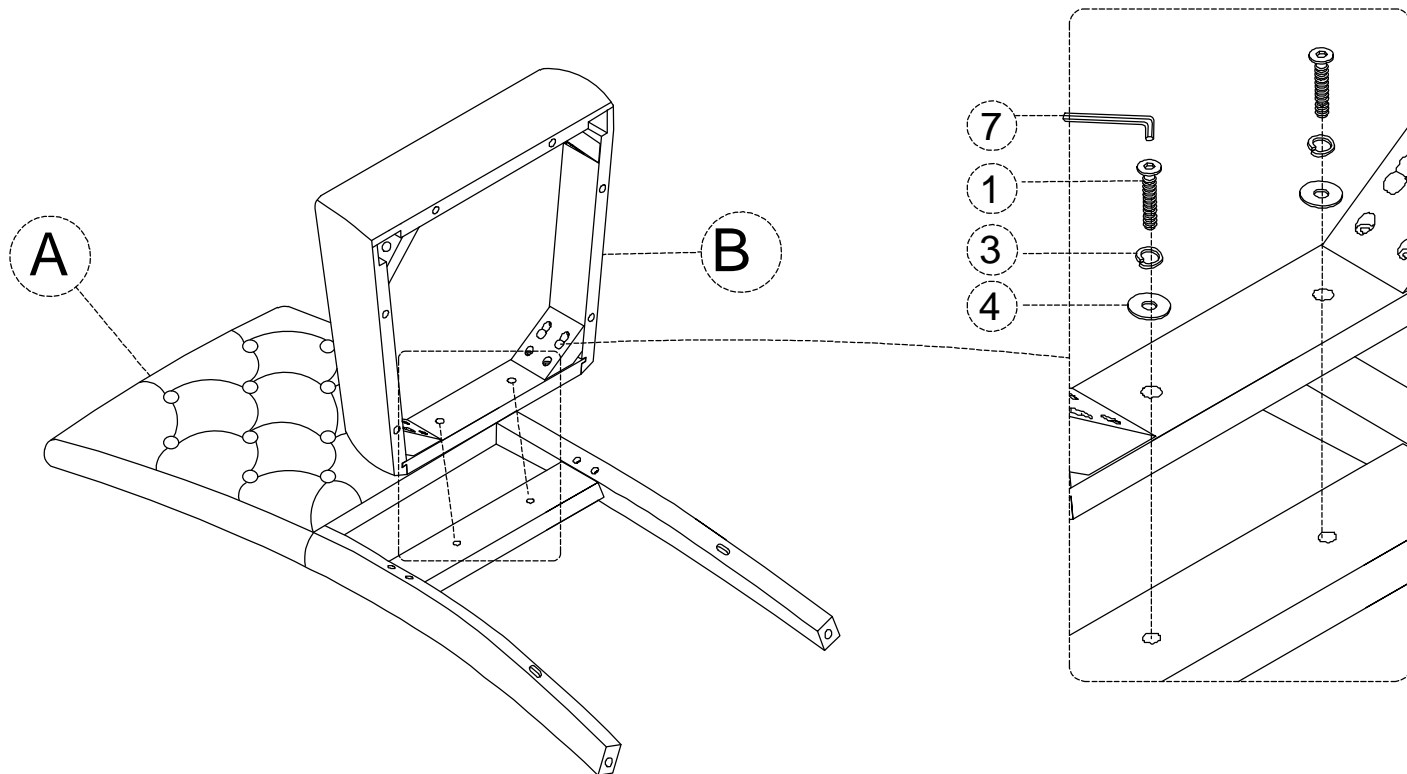
No	Parts Description.	Q'ty	No	Hardware Description.	Q'ty
A	BACK FRAME 	1pc	1	Bolts 1/4"x 35mm 	2pcs
			2	Bolts 1/4"x 75mm 	4pcs
B	SEAT FRAME 	1pc	3	Spring Washer 1/4"x 13mm x 1.5mm 	10pcs
			4	Flat Washer 1/4"x 16mm x 1.5mm 	10pcs
C	RIGHT STRETCHER 	1pc	5	Bolts 1/4"x 55mm 	4pcs
D	LEFT STRETCHER 	1pc	6	Screws 4 x 38mm 	6pcs
E	FRONT STRETCHER 	1pc	7	Allen Key 4mm x 60mm 	1pc
F	FRONT LEGS (LEFT) 	1pc			
G	FRONT LEGS (RIGHT) 	1pc			





### STEP 1

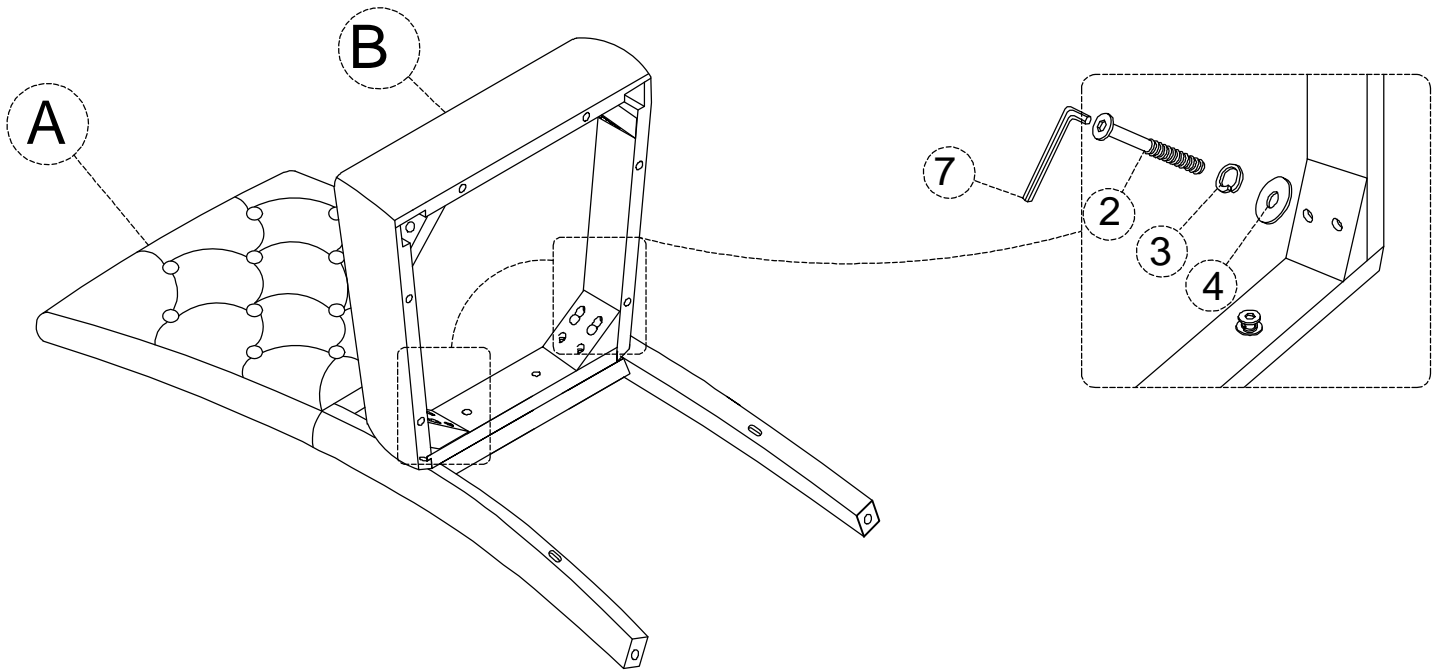

Bolts 1/4" x 35mm  ① x 2	Spring Washer 1/4" x 13mm x 1.5mm  ③ x 2	Flat Washer 1/4" x 16mm x 1.5mm  ④ x 2	Allen Key 4mm x 60mm  ⑦ x 1
--	---	--	---

# STEP 2



<b>Bolts</b> 1/4" x 75mm  ②x 4	<b>Spring Washer</b> 1/4" x 13mm x 1.5mm  ③x 4	<b>Flat Washer</b> 1/4" x 16mm x 1.5mm  ④x 4	<b>Allen Key</b> 4mm x 60mm  ⑦x 1
--	--	---	---



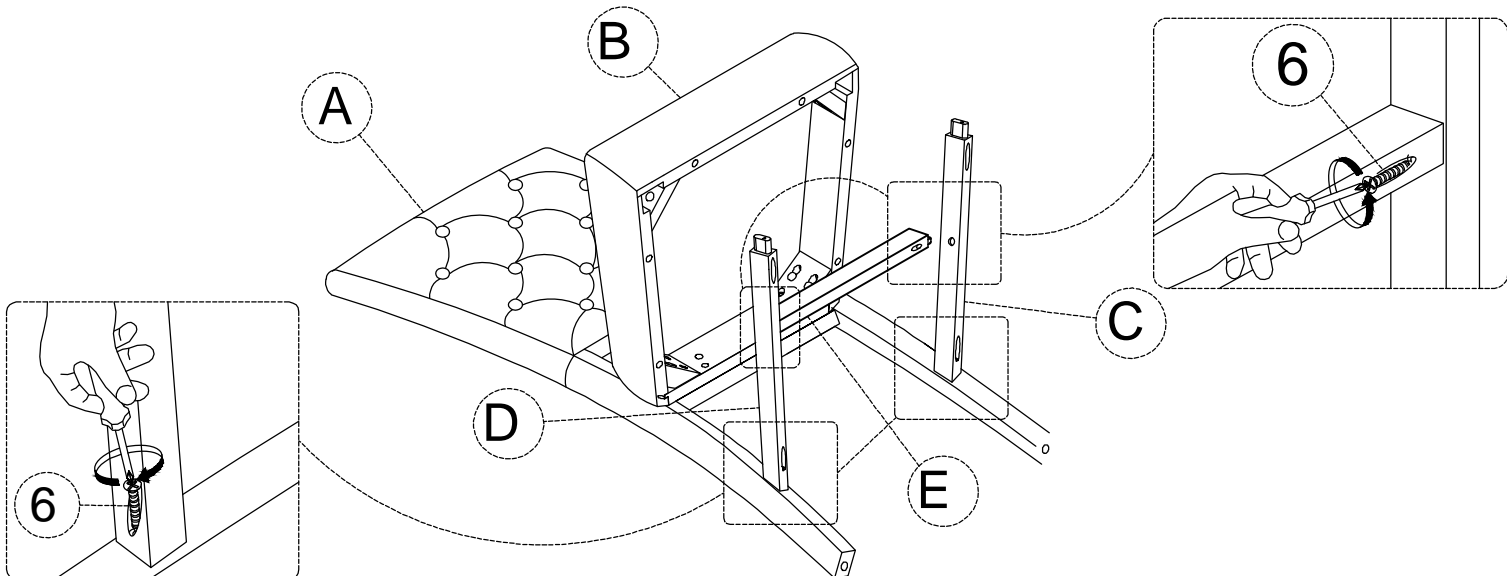

# STEP 3

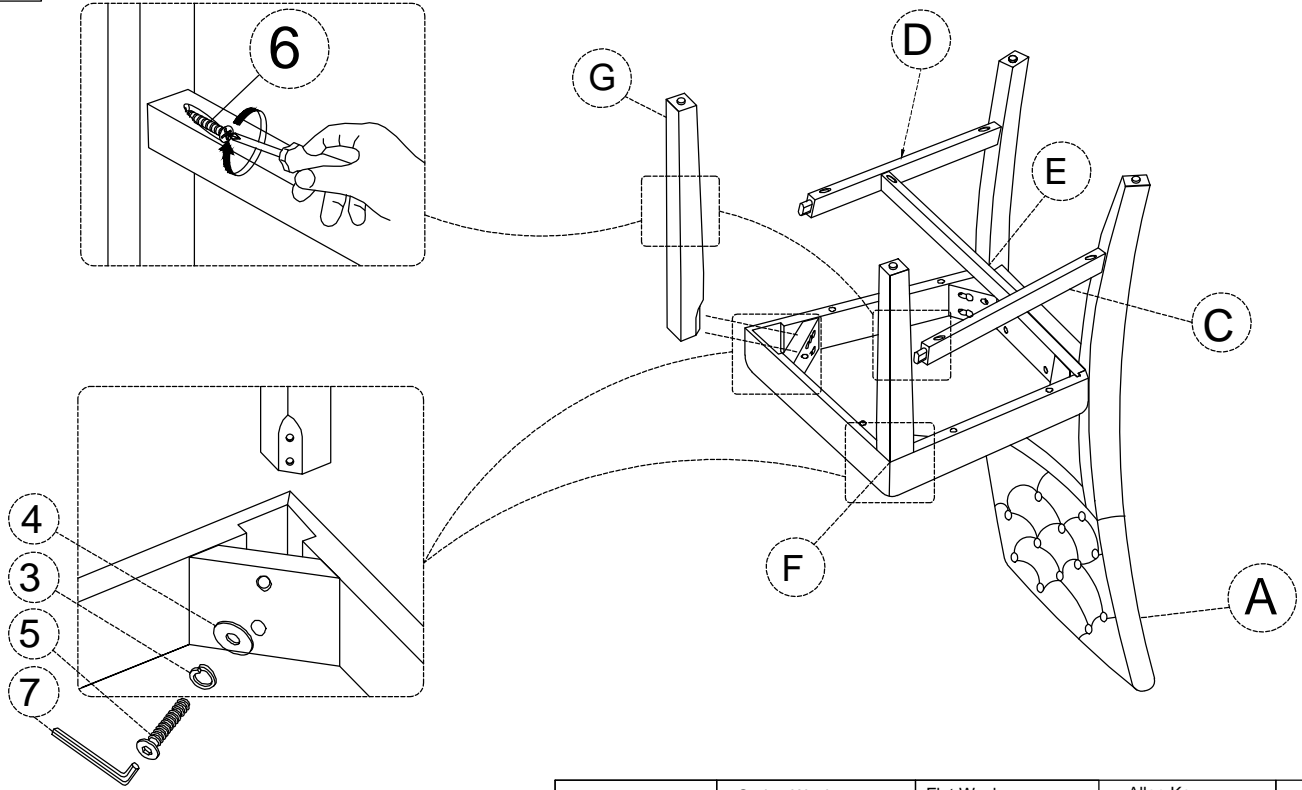

<b>Screws</b> 4 x 38mm  ⑥x 4
--

**STEP 4**



<b>Bolts</b> 1/4" 55mm  ⑤x 4	<b>Spring Washer</b> 1/4" x 13mm x 1.5mm  ③x 4	<b>Flat Washer</b> 1/4" x 16mm x 1.5mm  ④x 4	<b>Allen Key</b> 4mm x 60mm  ⑦x 1	<b>Screws</b> 4 x 38mm  ⑥x 2
--	--	--	---	--

**FINISH**

