

# INSTALLATION

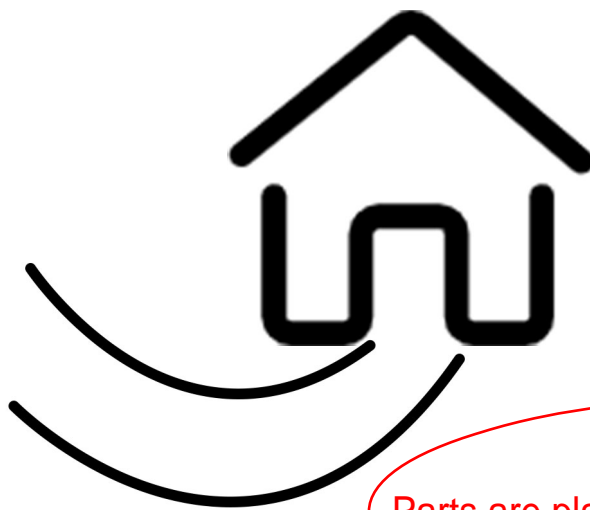

**CAUTION**









Parts are placed at the bottom of the product.

- If you have any questions with the product, please contact us

(we will reply to you within 24 hours)

# ASSEMBLY INSTRUCTIONS

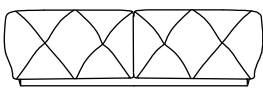
Parts of the list:

A*4PCS Leg 	B*5PCS Washer 	C*4PCS Screws 	D*4PCS Washer 	E*1PC Wrench 	F*1PC Middle Leg 
①*1PC Back Cushion 		②*1PC Seat 			

STEP1:

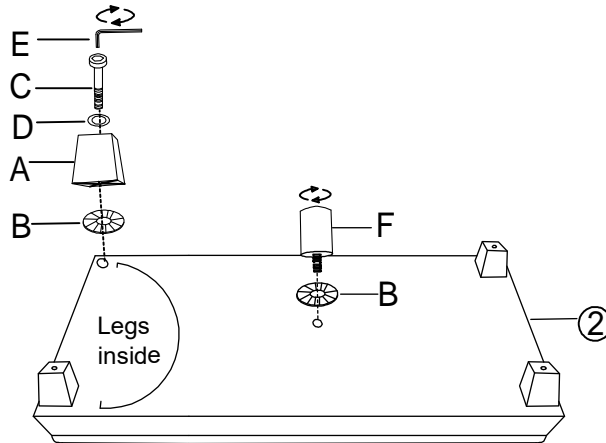

STEP2:

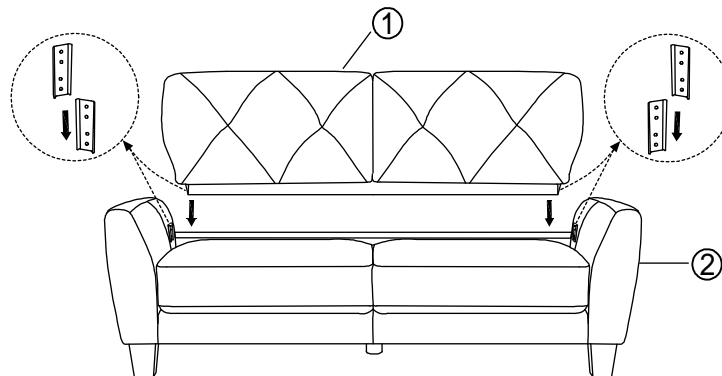

STEP3:

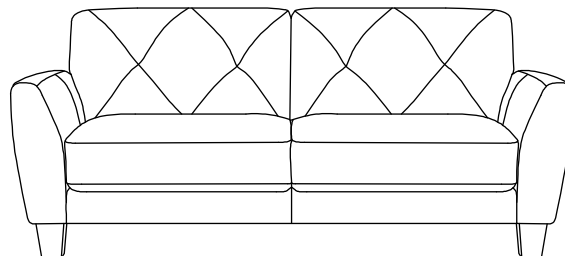

## Warnings

1. Please check if the components of the chair are all included and can be used normally.
2. Assemble all components according to the instruction correctly before you connect the chair to the power.
3. Please DO NOT sit on the armrests or footrest to eliminate the risk of tipping over.
4. If the chair is damaged or doesn't match the website description, please send clear pictures of the product and label of the carton to our service team for further help.
5. If the recliner doesn't work, you may try the following measures for self-checking firstly:
  - a) Check if all the cables are connected;
  - b) Check if the light of transformer is on.

If the chair still doesn't work, please feed the information back to our customer service in time and we'll help you solve the matter as soon as possible.

6. If you have any questions with the product, please contact us.  
(we. will re.ply to you within 24hours)

