







# BENCH ASSEMBLY INSTRUCTIONS

## Assembly Instruction

Please assemble on a soft surface after removing contents as not to scratch or damage stone surface.  
 Also, take caution with finger prints and dirt during assembly.  
 Wash with soft cloth and mild detergent like Dawn or Palmolive diluted with warm water. Scrub gently.  
 Enjoy!

Item	Description	Q'ty
A	 Bolt 8x80	02
B	 Bolt M8x50	04
C	 Flat Washer M8	04
D	 Washer	02
E	 Nut M8	02
F	 Allen Key	01
G	 Wrench	01

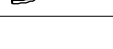
**STEP 1**

- Assemble two bench base legs with crossbar.
- Attach (2) "A" Bolts, (2) "D" Washers, (2) "E" Nuts.

**CAUTION: Insert "A" Bolts by hand and turn until they stop turning approx one-third to half way.**

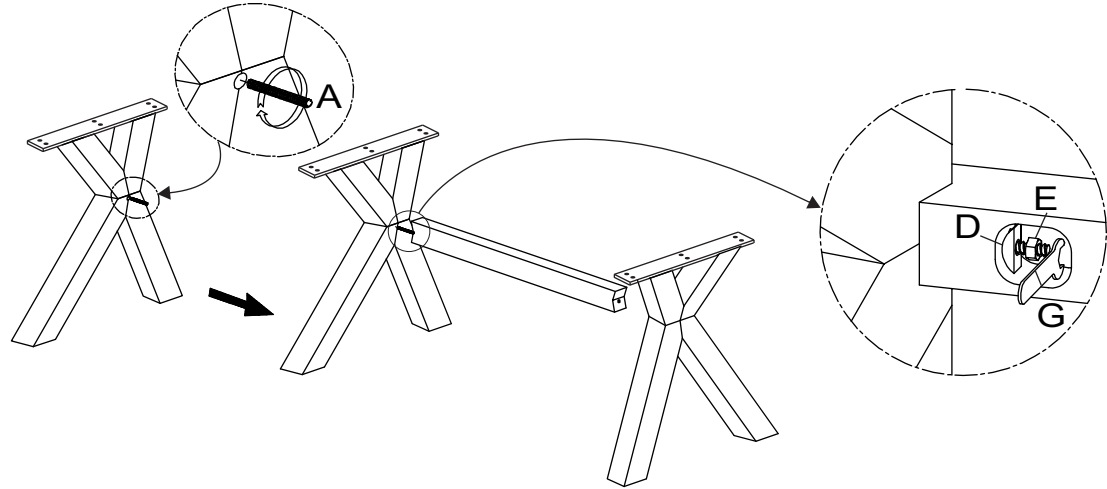

Bench Top

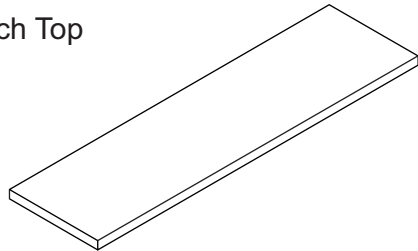

Bench Base(2pcs)

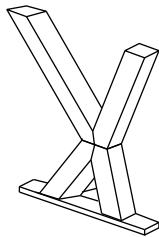

Crossbar

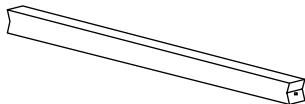

**STEP 2**

- Place Bench top on a soft surface upside down as shown.
- Fasten (4) "B" Bolts and (4) "C" Flat washers to table top underside and frame.

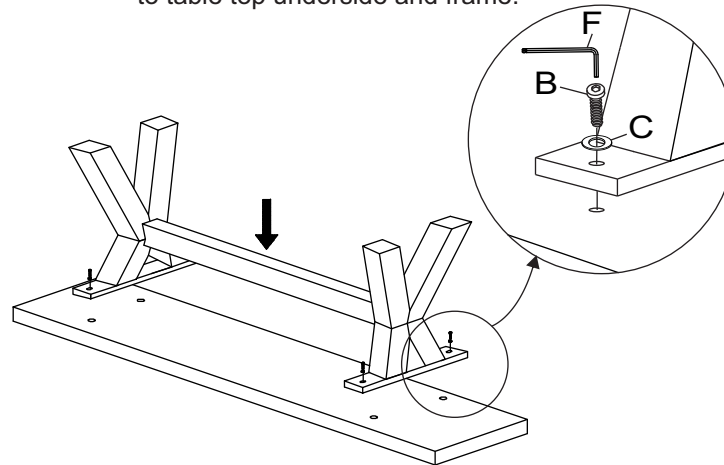

**STEP 3**

- With 2 people carefully stand Bench upright.

