











# ASSEMBLY INSTRUCTIONS

|      |  |
|------|--|
| Ax1  | Backrest                   |
| Sx1  | Seat                      |
| Bx2  | Front leg                 |
| Cx2  | Rear leg                  |
| Dx2  | Adjust cap                |
| Ex8  | Screw<br>M8*50mm          |
| Gx11 | M8<br>Spring washer      |
| Hx11 | M8*22mm<br>Flat washer  |
| Kx1  | Allen key  M8           |
| Lx1  |                         |

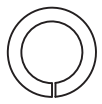
**①** The legs are hidden under the seat frame

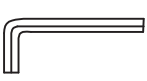

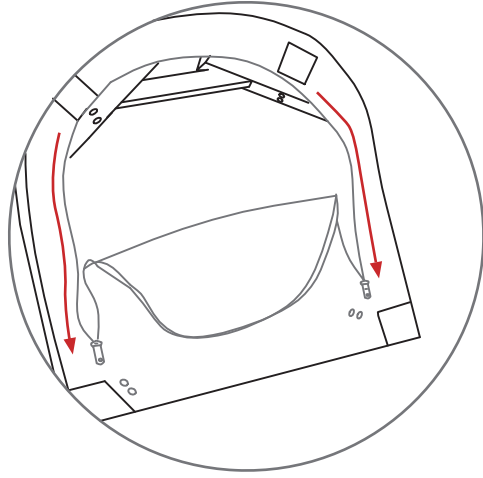
**②**

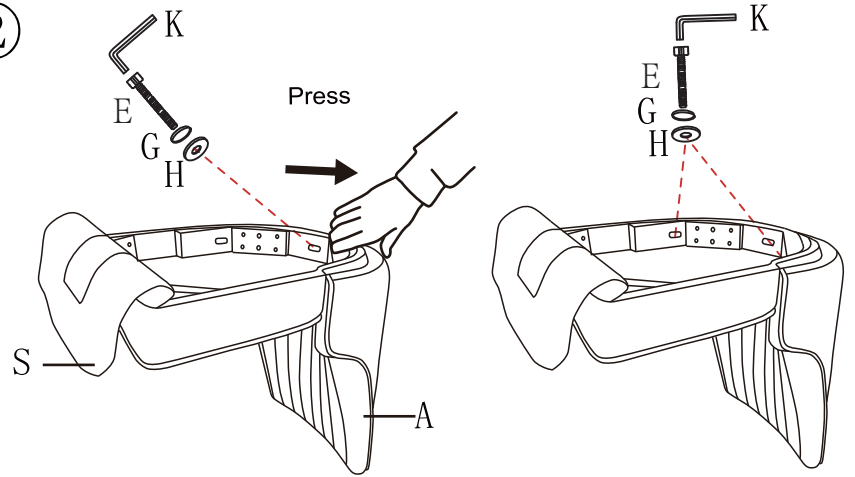

Press

First install the central screw and tighten it to 70%, then install the screws on both sides and tighten them to 80%

**③**

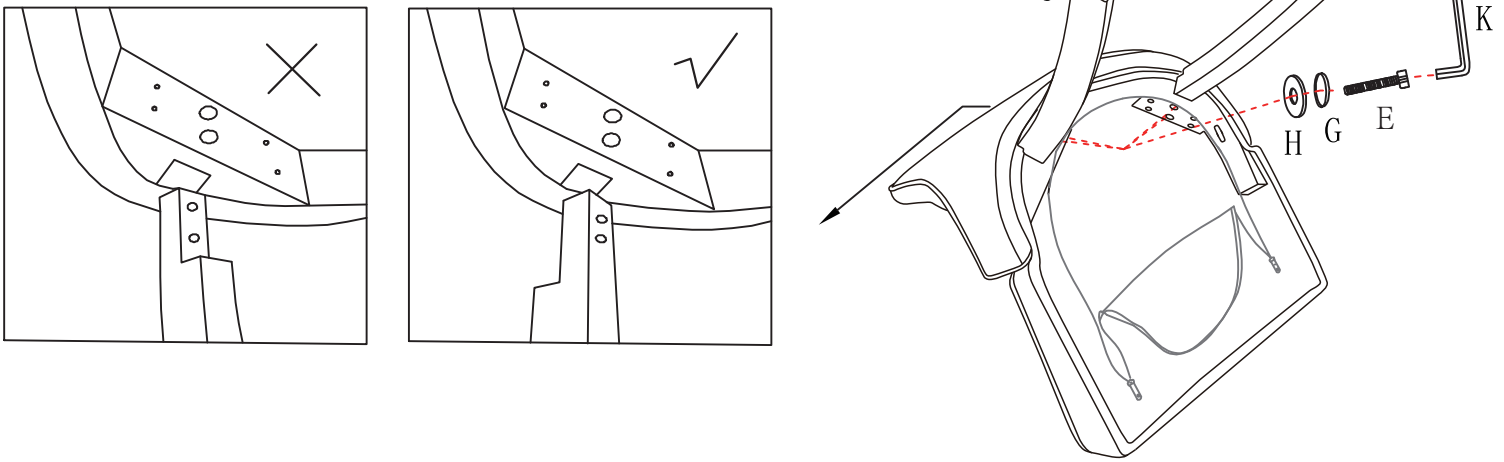

Tighten all the screws to 80% of maximum tightness

**WARNING:**

DO NOT STAND ON THE PRODUCT, DO NOT USE THIS PRODUCT AS A STEP LADDER.

DO NOT USE THIS PRODUCT UNLESS ALL BOLTS, SCREWS AND KNOBS ARE FIRMLY SECURED.

PLEASE DO NOT USE KNIFE TO OPEN ANY PARTS OF THE BOX OR PRODUCT.

4

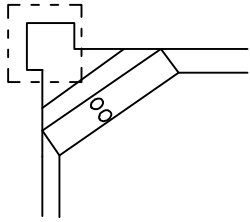

Put the front leg in the dotted box place, if you put it in the wrong place, it still can work, but the uneven force will cause the leg to break.

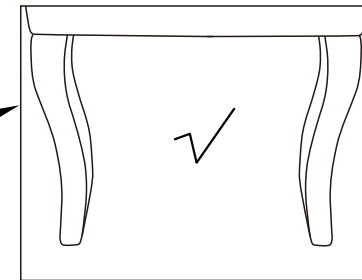
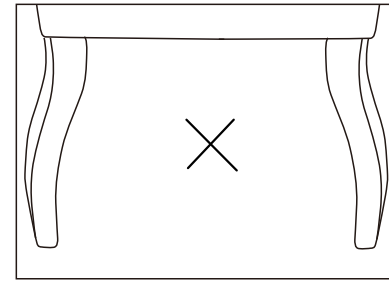
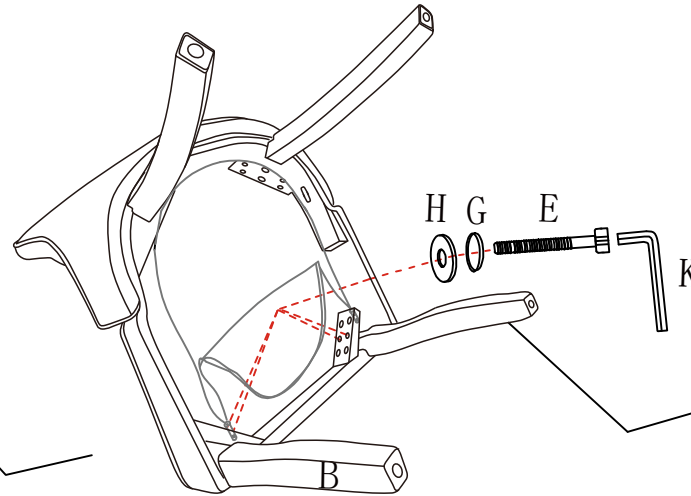

Tighten all the screws to 80% of maximum tightness

5

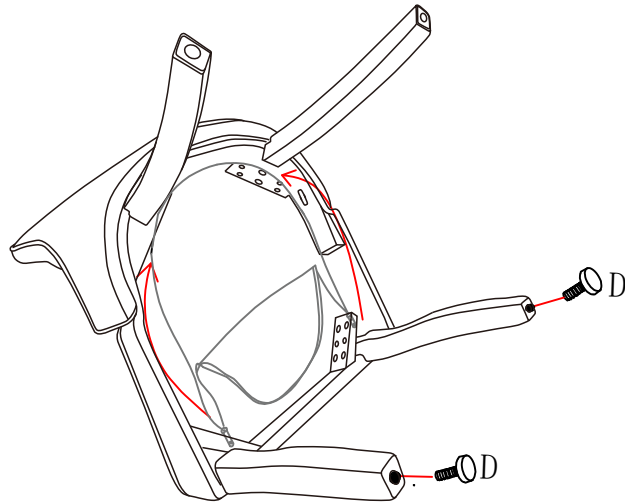

1. screw D into front legs.
2. Carefully sit on the chair and make adjustments to ensure the legs are flat even on the floor.
3. Tighten all the screws to 100% of maximum tightness
4. Close the zipper of bottom Non-Woven fabric.

6

There are 2 small adjusters on the front legs, ensure these are adjusted so the chair sits level.

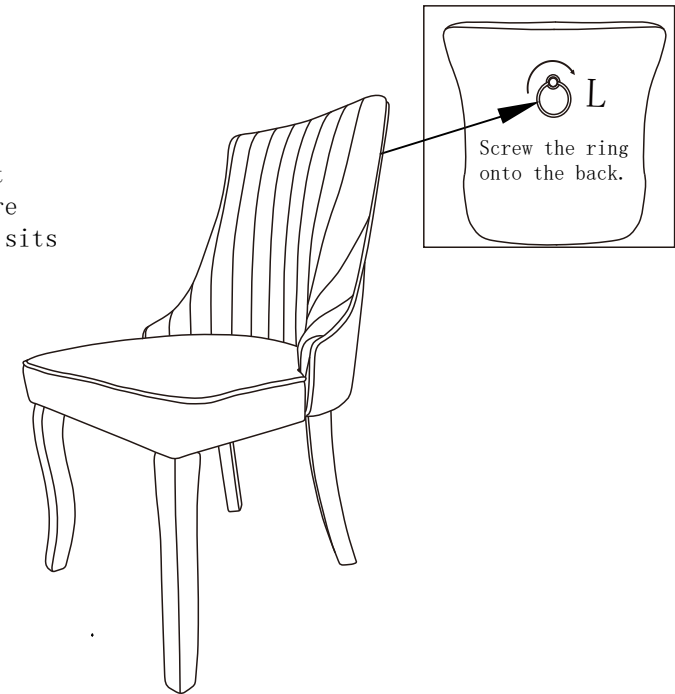

Tighten one and loosen the other, to adjust to level.

4

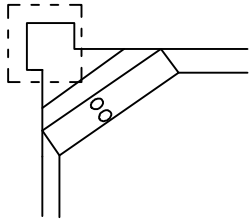

Put the front leg in the dotted box place, if you put it in the wrong place, it still can work, but the uneven force will cause the leg to break.

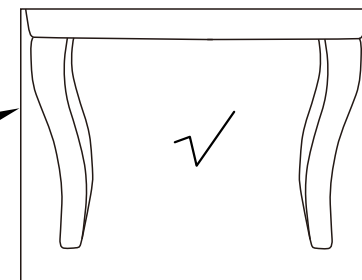
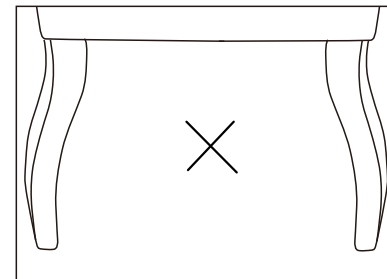
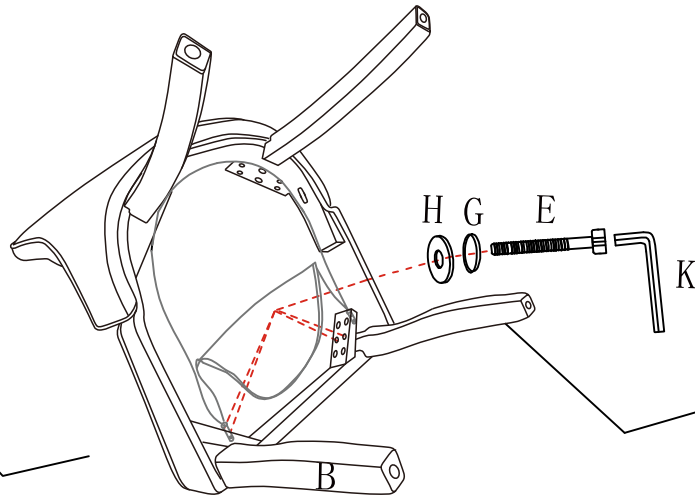

Tighten all the screws to 80% of maximum tightness

5

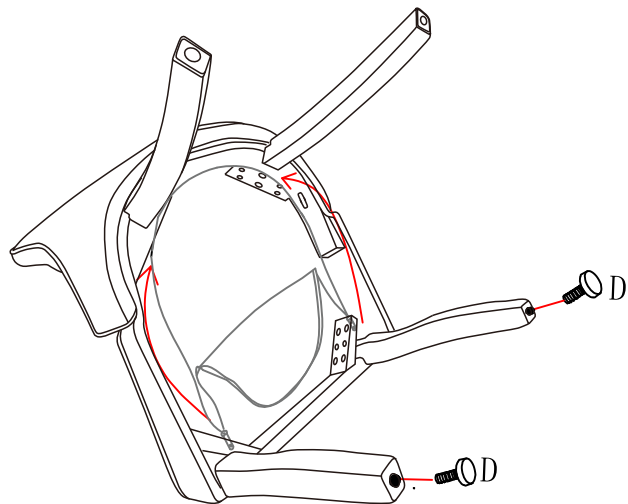

1. screw D into front legs.
2. Carefully sit on the chair and make adjustments to ensure the legs are flat even on the floor.
3. Tighten all the screws to 100% of maximum tightness
4. Close the zipper of bottom Non-Woven fabric.

6

There are 2 small adjusters on the front legs, ensure these are adjusted so the chair sits level.

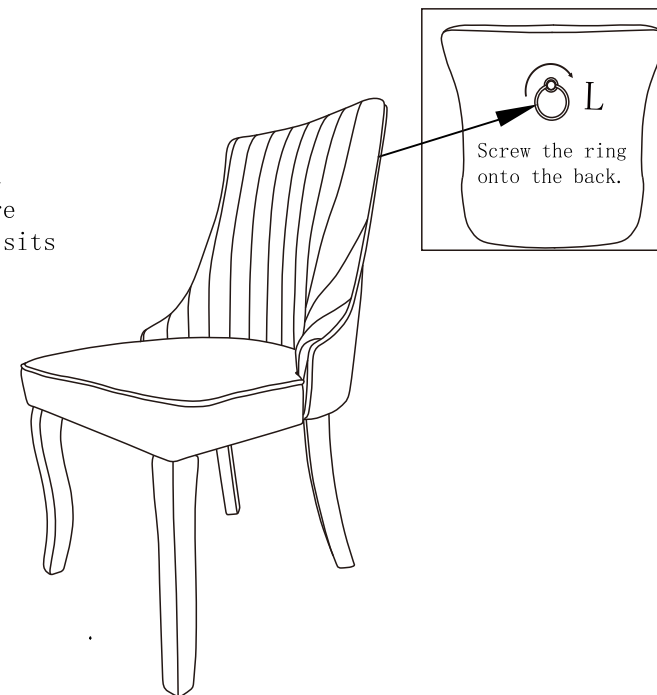

Tighten one and loosen the other, to adjust to level.