

Installation instructions

Thank you for purchasing our products. If there is any missing, please kindly send us messages to let us know the name of missing part regarding to the first page of instructions. We will send replacement to you asap. We are concerned about each customer's experience, if there is any loss or damage, please contact us at any time, we will provide effective solutions.
 Customer service
 Please attach your Oder ID so that we can assist you better.

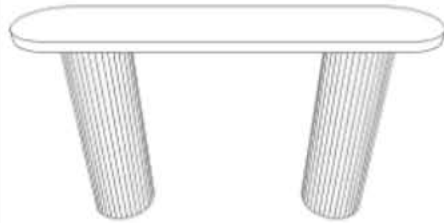

01 Dx8 Ex8

Please tighten the screws to 70% first, and tighten screws 100% after all screws assembled.

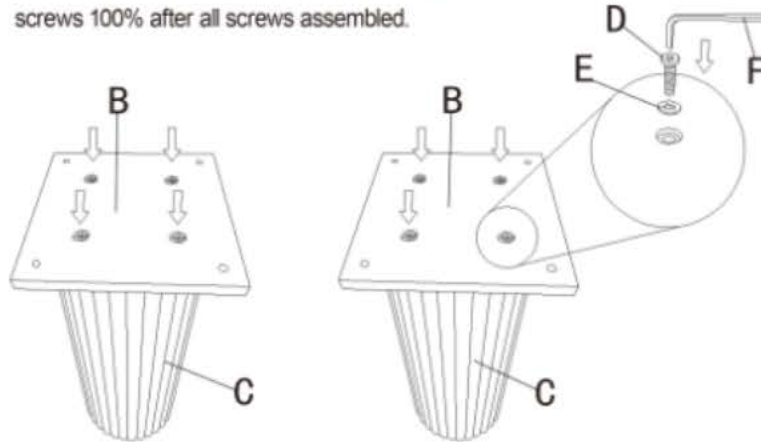

02 Dx8 Ex8

Please tighten the screws to 70% first, and tighten screws 100% after all screws assembled.

If the holes don't align, go back to Step 1 and adjust Panel B.

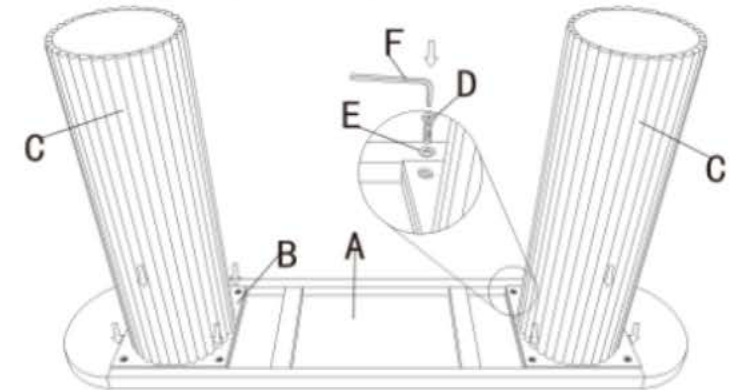

A X 1



B X 2



C X 2



D X 16+1



E X 16+1



F X 1



G X 6



03 Gx6

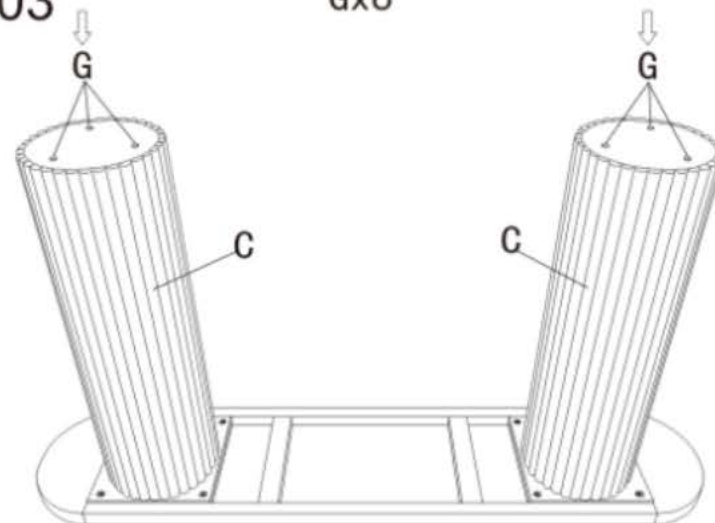

04

